



FIRE BOND®

BRANDTÄTNINGAR/ BRANDTÆTNINGER /
BRANNTETNINGER / PALOTIIVISTEET

Teknisk/Tekninen
Guide



Fire Bond® produktguide / tuoteopas

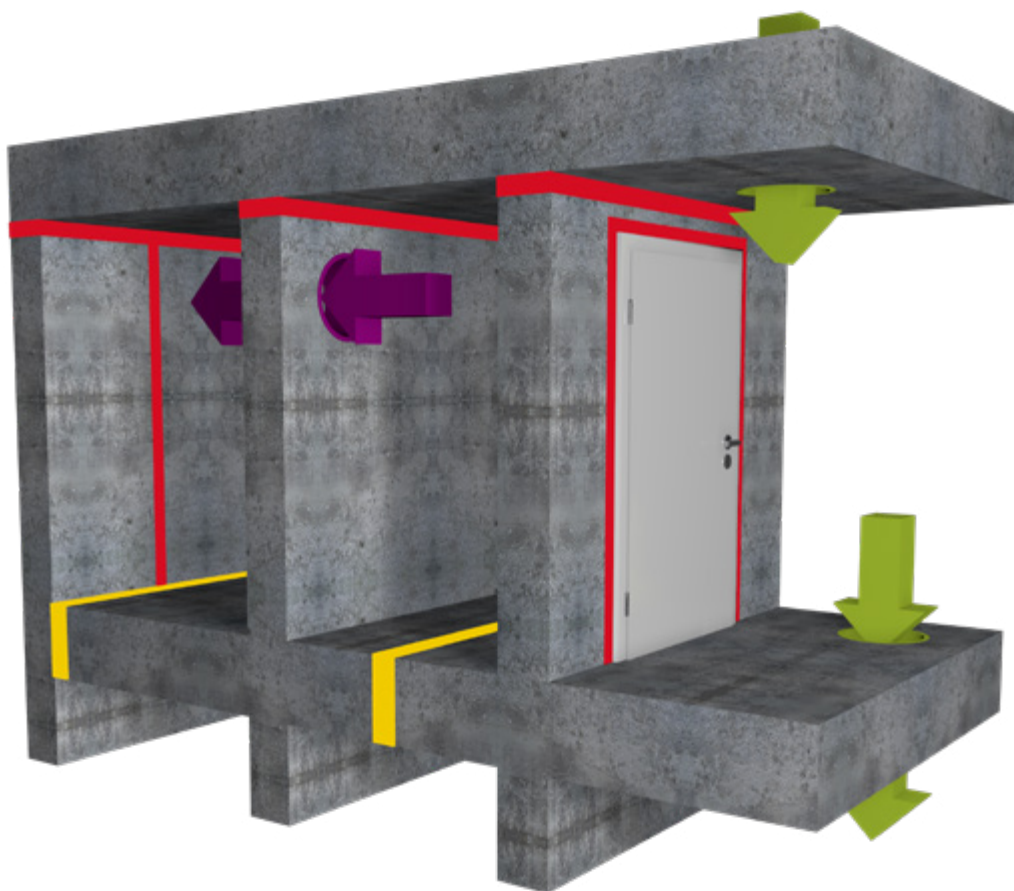

F1-
F18







F20-
F23



F30-
F39



F40-
F42

				
SE Produkt	Linjära fogar i vägg	Linjära fogar i golv	Genomföringar i vägg (rör + kablar)	Genomföringar i golv (rör + kablar)
DK Produkt	Lineære fuger i væg	Lineære fuger i gulv	Gennemføringer i væg (rør + kabler)	Gennemføringer i gulv (rør + kabler)
NO Produkt	Lineære fuger i vegg	Lineære fuger i gulv	Gjennomføringer i vegg (rør + kabler)	Gjennomføringer i gulv (rør + kabler)
FI Tuote	Suorat saumat seinissä	Suorat saumat lattioidsa	Läpiviennit seinissä (putket ja kaapelit)	Läpiviennit lattioidsa (putket ja kaapelit)
FIRE BOND GAP SEAL+	●	●	●	●
FIRE BOND SILMAX PRO	●			
FIRE BOND PRESSURE SEAL+ *			●	●
FIRE BOND FOAM SEAL+	●		●	
FIRE BOND FOAM PRO 2K	●		●	●

PRODUKTER / TUOTTEET

M1 EMISSION CLASS FOR BURNING MATERIAL

SILMAX PRO

SE Flexibel fogmassa SMP för anslutningsfogar. Stor rörelseupptagande förmåga ±25% av fogbredden.





DK Flexibel fugemasse SMP til forbindelsesfuger. Stor bevægelsestolerance ±25 % af fugebredden.

NO Flexibel fugemasse SMP for tilkoblingsfuger. Gode bevægelsesabsorberende egenskaper ±25% av fugebredden.

FI Joustava saumamassa SMP liitääntäsaumoihin. Joka kestää suurtakin liikettä (±25 % sauman leveydestä).



RISE European Technical Approval (ETA) ETA 17/0455 RISE (P-mark) 0047/07

F4, F6, F8-F12

M1 EMISSION CLASS FOR BURNING MATERIAL

GAP SEAL+

SE Vattenbaserad akrylfogmassa. Rörelseupptagande förmåga ±15% av fogbredden.







DK Vandbaseret/akrylfugemasse. Bevægelsestolerance ±15 % af fugebredden.

NO Vannbasert/akrylfugemasse. Bevegelsesabsorberende egenskaper ±15% av fugebredden.

FI Vesiliukoinen/akryylisaumamassa. Kestää suurtakin liikettä (±15 % sauman leveydestä).



CLASSIFIED **UL** European Technical Approval (ETA) ETA 17/0935, ETA 17/0936 UL EU Certificate

F1-F7 F20-F23 F30-F33 F40-F41

M1 EMISSION CLASS FOR BURNING MATERIAL

PRESSURE SEAL+

SE Specialfog/akryl för genomföringar -sväller vid brand. Rörelseupptagande förmåga ±10%.



DK Special-/akrylfugemasse til gennemføringer - ekspanderer ved brand. Bevægelsestolerance ±10%.



NO Spesialfuge/akryl for gjennomganger - utvider seg ved brann. Bevegelsesabsorberende egenskaper ±10%.

FI Erikoismassa läpivienneille -turpoaa palossa Murtolujuuskesto ±10%.



CLASSIFIED **UL** European Technical Approval (ETA) ETA 17/0932 UL EU Certificate

F33-F35 F40-F41

FOAM SEAL+

SE Brandhämmande 1-komponents pistolskum av polyuretan.





DK Brandhæmmende 1-komponentpistolskum af polyuretan.

NO Brannhemmande 1-komponents pistolskum av polyuretan.

FI Palonestävä 1-komponenttinen polyuretaani-pistoolivaaho.



CLASSIFIED **UL** European Technical Approval (ETA) ETA 17/0934, ETA 17/0933 UL EU Certificate

F13-F16 F38-F39

FOAM PRO 2K

SE Brandhämmande 2-komponent fogsikum. Härdar helt oberoende av luftfuktighet.



DK Brandhæmmende 2-komponents fugeskum. Hærder helt uafhængigt af luftfugtigheden.

NO Brannhemmande 2-komponents fugeskum. Herder helt uavhengig av luftfuktighet.

FI Palonestävä 2-komponenttinen saumavaaho. Kovettuu täysin ilman kosteudesta riippumatta.



RISE (Produktdokumentation) RISEFR 030-0237

F16-F18 F36-F37 F42

BACKING WOOL

SE Formstabil brandisolering av keramisk ull.

DK Formstabil brandisolering med keramisk uld.

NO Formstabil brannisolering av keramisk ull.

FI Muotopysyvä paloeristystä keraamisella villalla.



Konstruktioner / Konstruktioner Konstruksjoner / Rakenteet

SE MATERIALBESKRIVNING
DK MATERIALEBESKRIVELSE
NO MATERIALBESKRIVELSE
FI MATERIAALIKUVAUS



SE Betong **DK** Beton
NO Betong **FI** Betoni



SE Brandfog **DK** Brandfuge
NO Brannfuge **FI** Palosauma



SE Gipsskiva **DK** Gipsplader
NO Gipsplate **FI** Kipsilevy



SE Stål **DK** Stå
NO Stål **FI** Teräs



SE Branddrev **DK** Brandbagstop
NO Brannetting **FI** Paloeriste



SE Rör **DK** Rør
NO Rør **FI** Putket



SE Isolering **DK** Isolering
NO Isolasjon **FI** Eristys



SE Kablar **DK** Kabler
NO Kabler **FI** Kaapelit



SE Trä **DK** Træ
NO Tre **FI** Puu



SE Gummiisolering
DK Gummiisolering
NO Gummiisolasjon
FI Kumieriste



SE Fogskum **DK** Fugeskum
NO Fugeskum **FI** Saumavaahdot



SE LINJÄRA FOGAR I VÄGG
DK LINEÆRE FUGER I VÆG
NO LINEÆRE FUGER I VEGG
FI SUORAT SAUMAT SEINISSÄ

F1

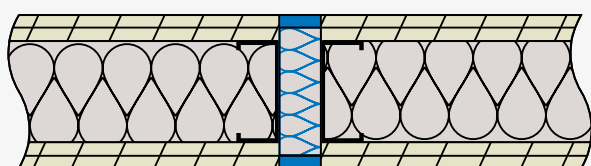

F2

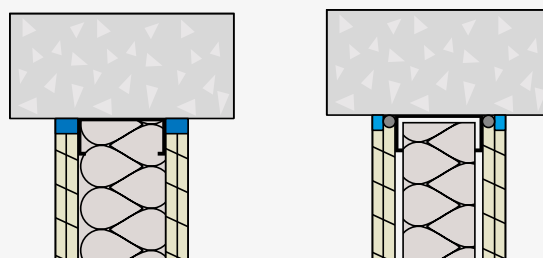



SE LINJÄRA FOGAR I VÄGG
DK LINEÆRE FUGER I VÆG
NO LINEÆRE FUGER I VEGG
FI SUORAT SAUMAT SEINISSÄ

F3

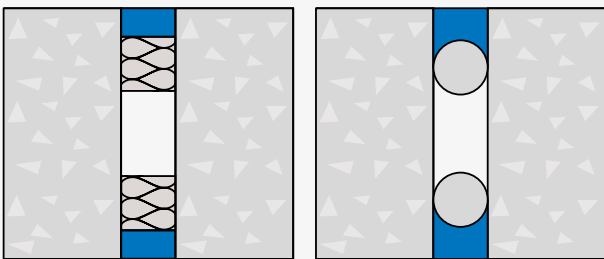

F4

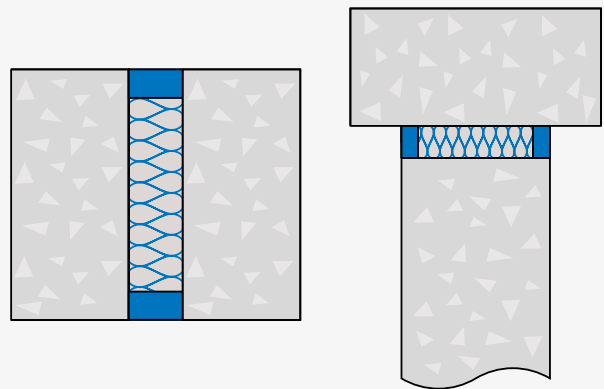

F5

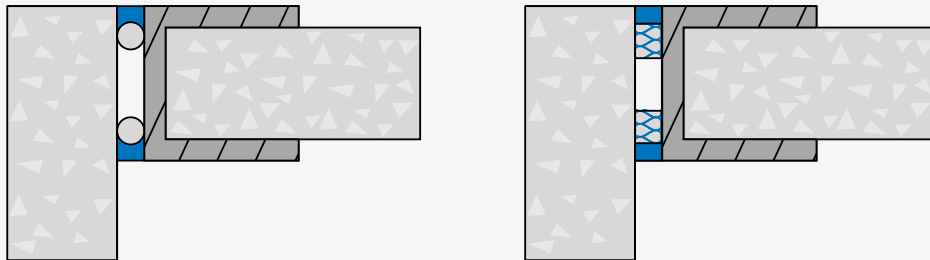

F6

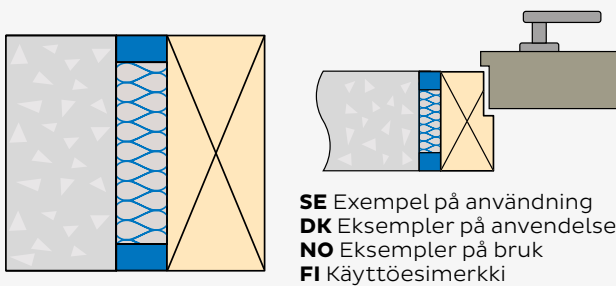

F7

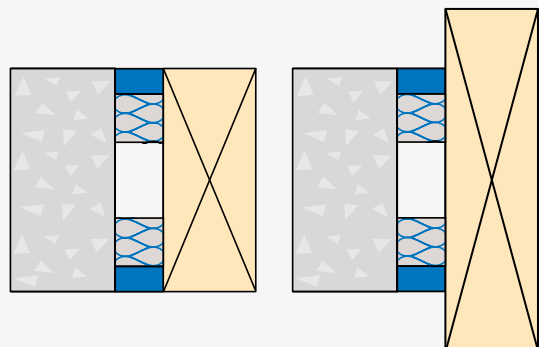



SE LINJÄRA FOGAR I VÄGG
DK LINEÆRE FUGER I VÆG
NO LINEÆRE FUGER I VEGG
FI SUORAT SAUMAT SEINISSÄ

F8

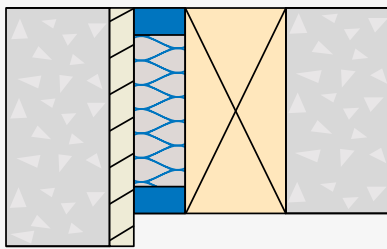

F9

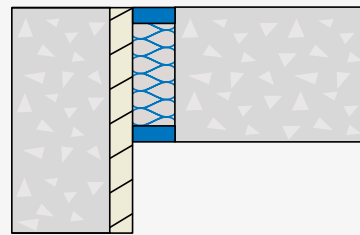

F10

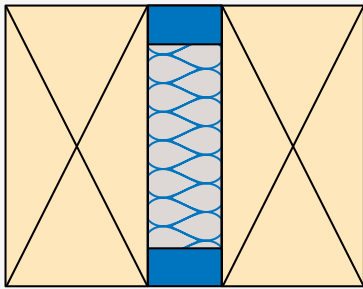

F11

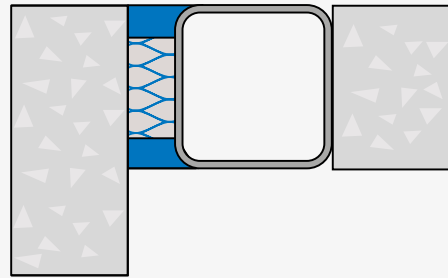

F12

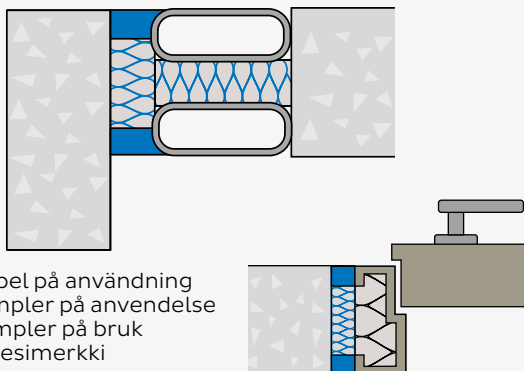

SE Exempel på användning
DK Eksempler på anvendelse
NO Eksempler på bruk
FI Käyttöesimerkki

F13

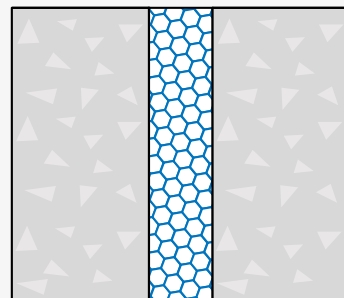



SE LINJÄRA FOGAR I VÄGG
DK LINEÆRE FUGER I VÆG
NO LINEÆRE FUGER I VEGG
FI SUORAT SAUMAT SEINISSÄ

F14

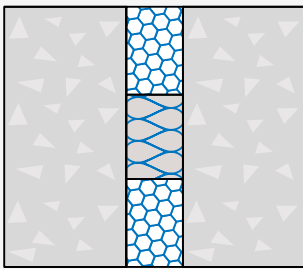

F15

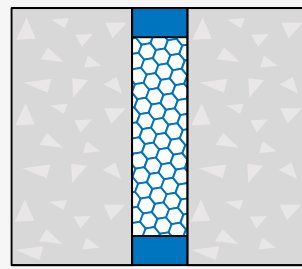

F16

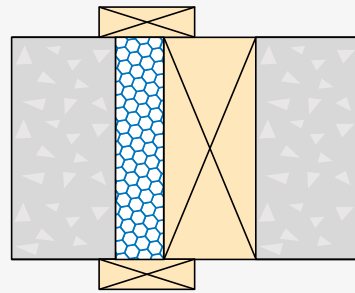
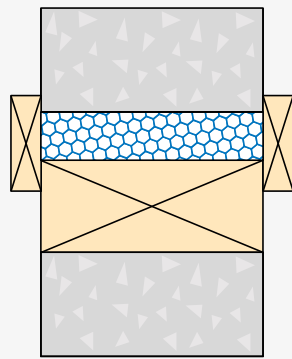

F17

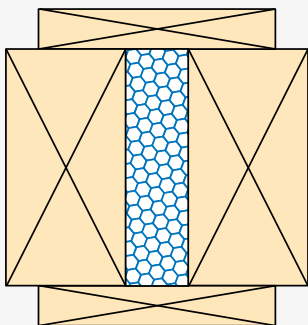

F18

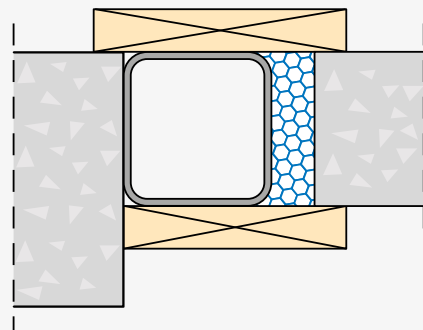



SE LINJÄRA FOGAR I GOLV
DK LINEÆRE FUGER I GULV
NO LINEÆRE FUGER I GULV
FI SUORAT SAUMAT LATTIOISSA

F20

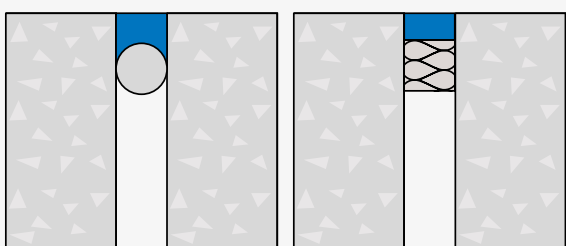

F21

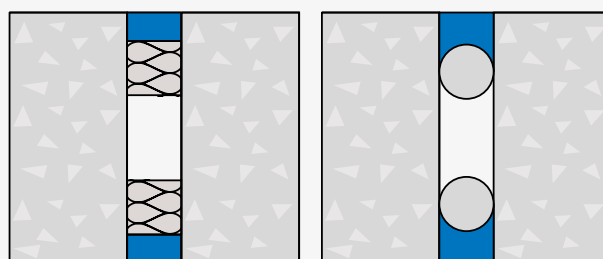

F22

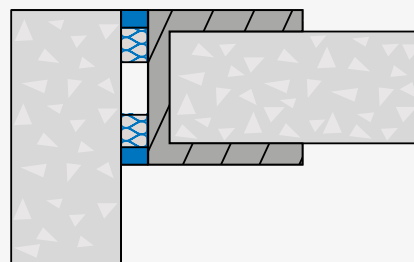
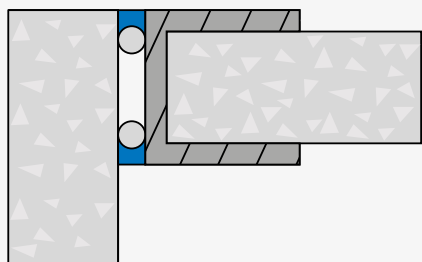

F23

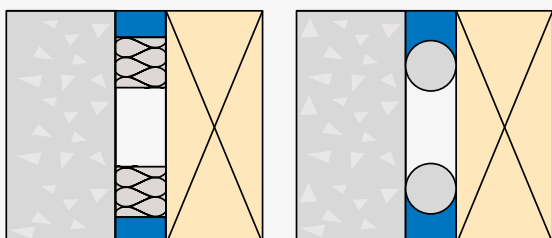



SE GENOMFÖRINGAR I VÄGG
DK GENNEMFØRINGER I VÆG
NO GJENNOMFØRINGER I VEGG
FI LÄPIVIENIT SEINISSÄ

F30

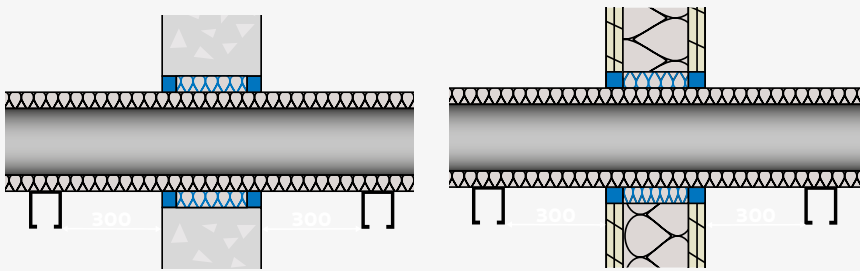

F31

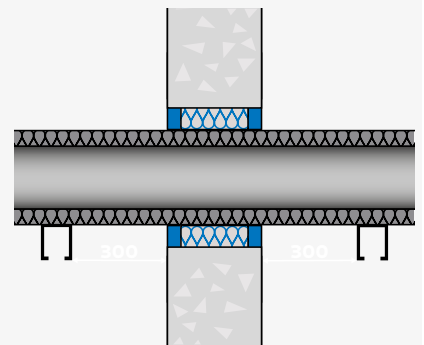

F32

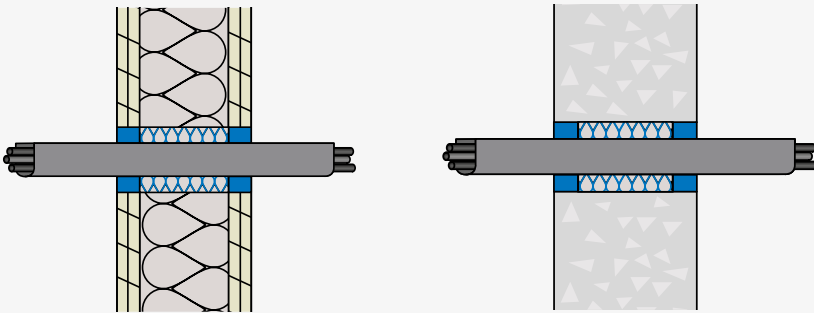

F33

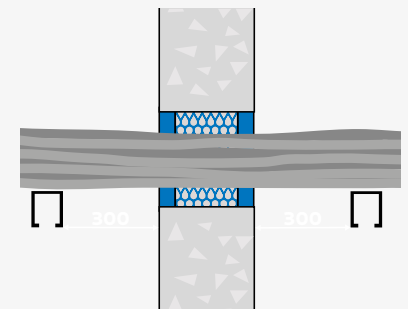

F34

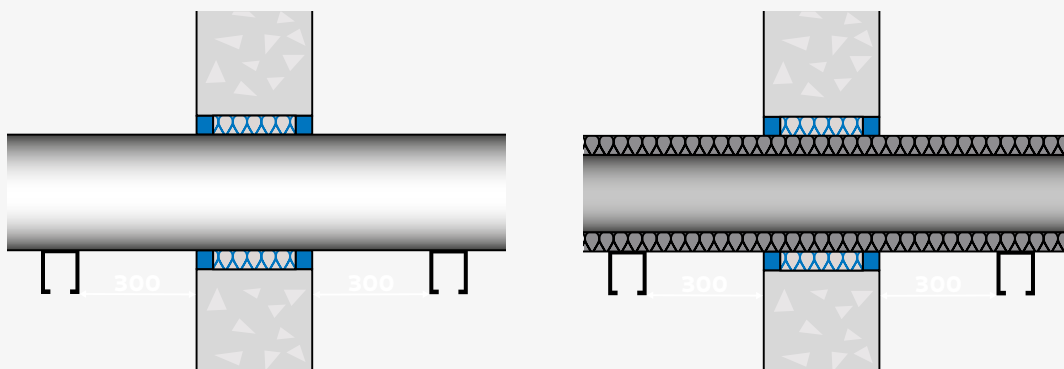



SE GENOMFÖRINGAR I VÄGG
DK GENNEMFØRINGER I VÆG
NO GJENNOMFØRINGER I VEGG
FI LÄPIVIENIT SEINISSÄ

F35

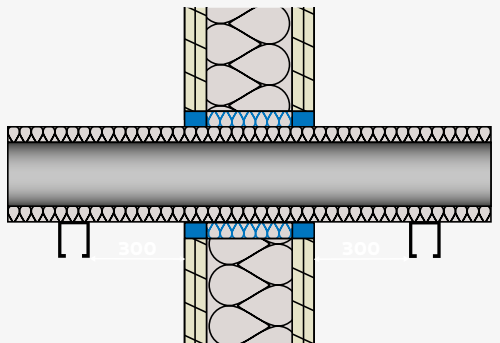
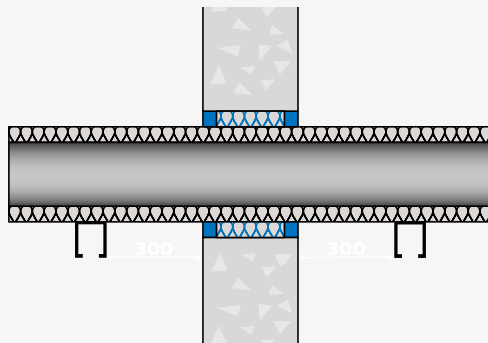
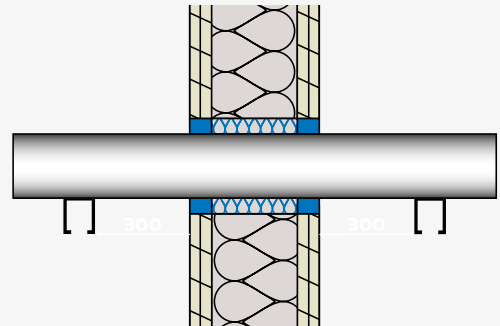
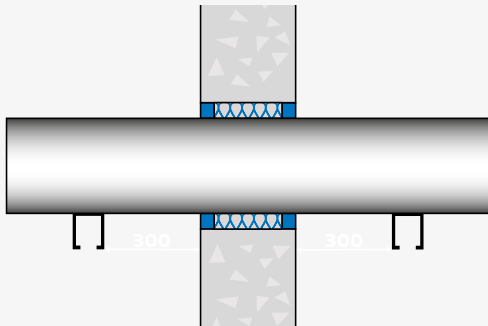

F36

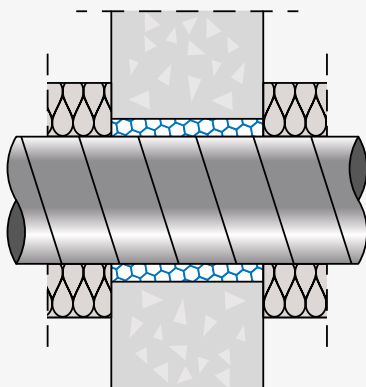

F37

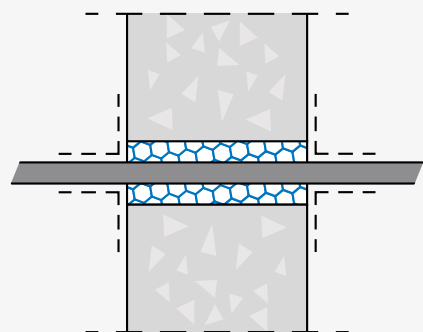



SE GENOMFÖRINGAR I VÄGG
DK GENNEMFØRINGER I VÆG
NO GJENNOMFØRINGER I VEGG
FI LÄPIVIENIT SEINISSÄ

F38

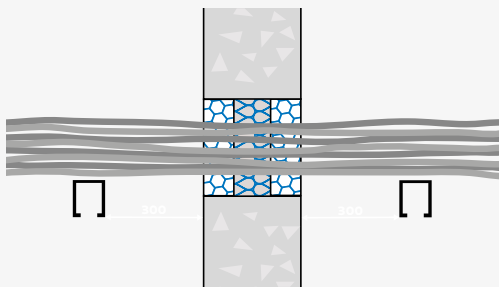

F39

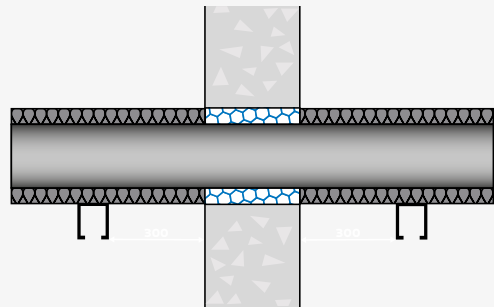

SE GENOMFÖRINGAR I GOLV OCH INNERTAK
DK GENNEMFØRINGER I GULVE OG LOFTER
NO GJENNOMFØRINGER I GULV OG INNERTAK
FI LÄPIVIENIT LATTIASSA JA SISÄKATOSSA

F40

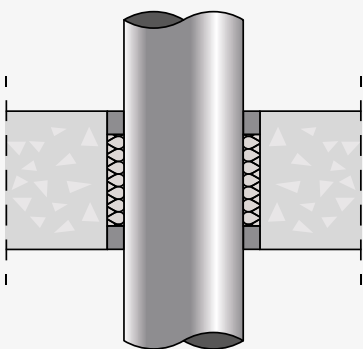

F41

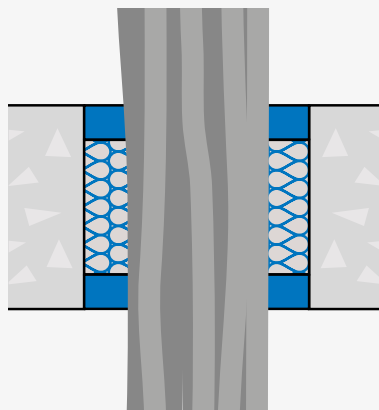

F42

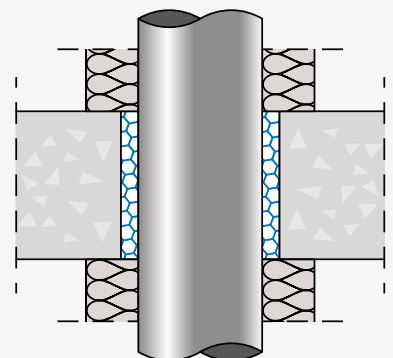



SE Smart hjälp 042 19 50 00

DK Smart hjælp 44 84 15 00

NO Smart hjelp 69 19 06 00

FI Smart help +358 10 843 88 00

Bostik AB / Bostik A/S / Bostik AS / Bostik OY

Strandbadsvägen 22,
251 09, Helsingborg, Sweden
An Arkema Company

www.bostik.se / bostik.dk / bostik.no / bostik.fi