

Installation North America only

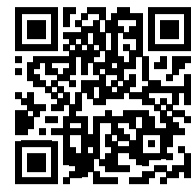
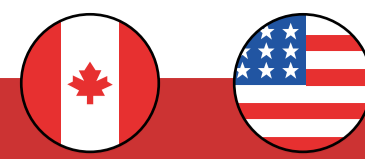

For full installation videos of screwing or gluing the panels scan QR code or visit fibosystemusa.com

HOW TO SEAL FIBO WALL PANELS

For watertight system, apply Fibo Seal as shown beneath. All cutting surfaces must be sealed, also when drilling holes for pipe penetration. Incorrect installation will void your warranty. Use Fibo Clean and Fibo Wipes to remove excessive sealant. Film from cleaning accessories shall be removed immediately from the panels.

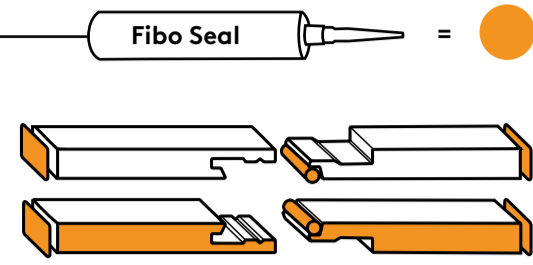

1 CHOOSE PREFERRED BACKWALL

Make sure the backwall is level and the corners are straight 90°. For uneven walls we recommend using OSB Strips and if necessary extra shims to even out.

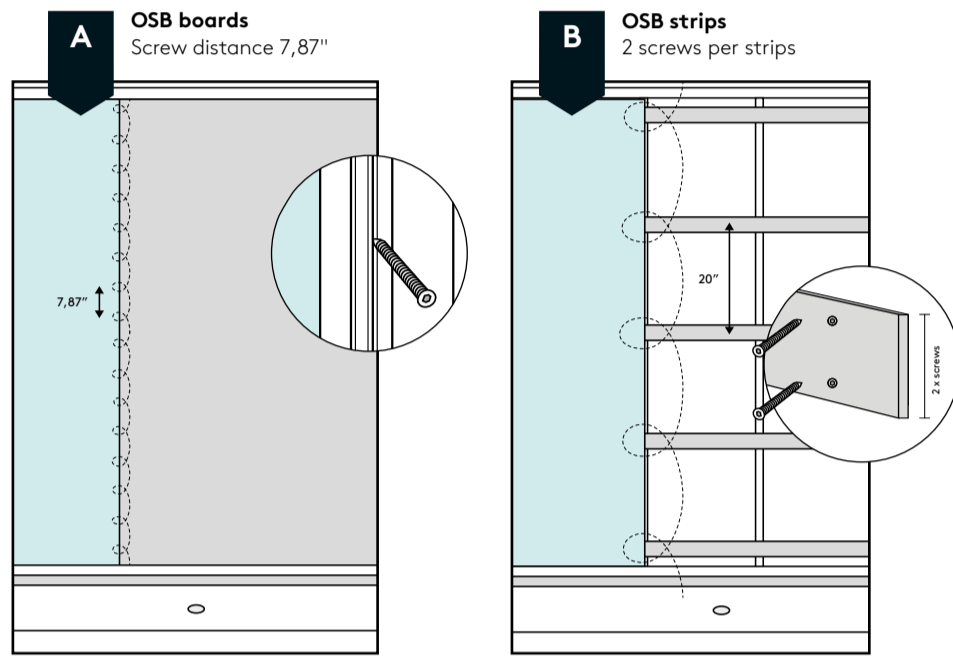

WARNING: This product can expose you to chemicals including formaldehyde and acetaldehyde, which is known to the State of California to cause cancer. For more information, go to www.P65Warnings.ca.gov

WARNING: Fumes Hazard: The fumes from the Fibo Clean used by the installer can be harmful if used in an unventilated room. Always work in a well-ventilated area. To keep the area well-ventilated, open windows and use exhaust fans. If adequate ventilation is not achievable or practical, use respiratory protective equipment.



2 FAUCETS, NICHES, PIPE PENETRATIONS AND WINDOW SILLS

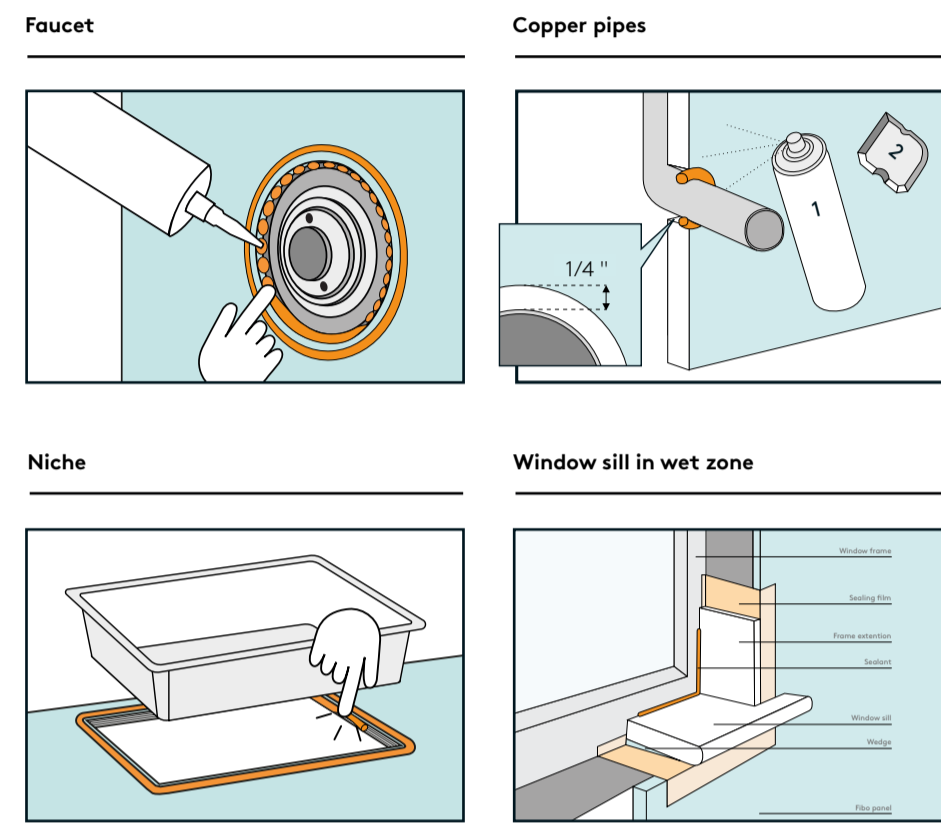

READ BEFORE OPENING PACKAGE!

Wall panel Veggpanel

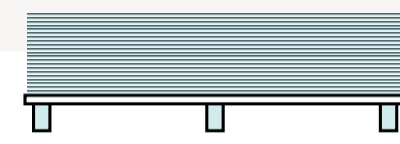

Storage | Lagring
Keep panels dry stored and flat in package until installation.

Lagre panelene tørt og liggende i emballasjen frem til monteringen.

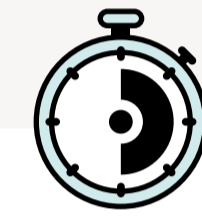

Min. 72 hours | Min. 72 timer
Store panels in package in room conditions for at least 72 hour acclimatization (longer if they have been kept in a cold area). Humidity in the room must be above 50% during installation.

Akklimatiser emballerte paneler i romtemperatur i minst 72 timer (mer hvis de har vært på kaldt lager). Luftfuktigheten i rommet må være mer enn 50% både under og etter monteringen.

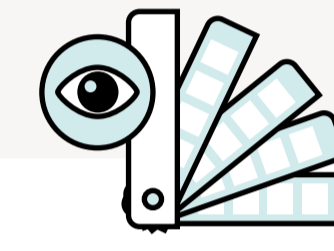

Visual control | Visuell kontroll
Colourmatch and check for flaws before installation.
Kontroller farge og sjekk for andre feil før monteringen.

3 ALCOVE - STANDARD WALLPANEL

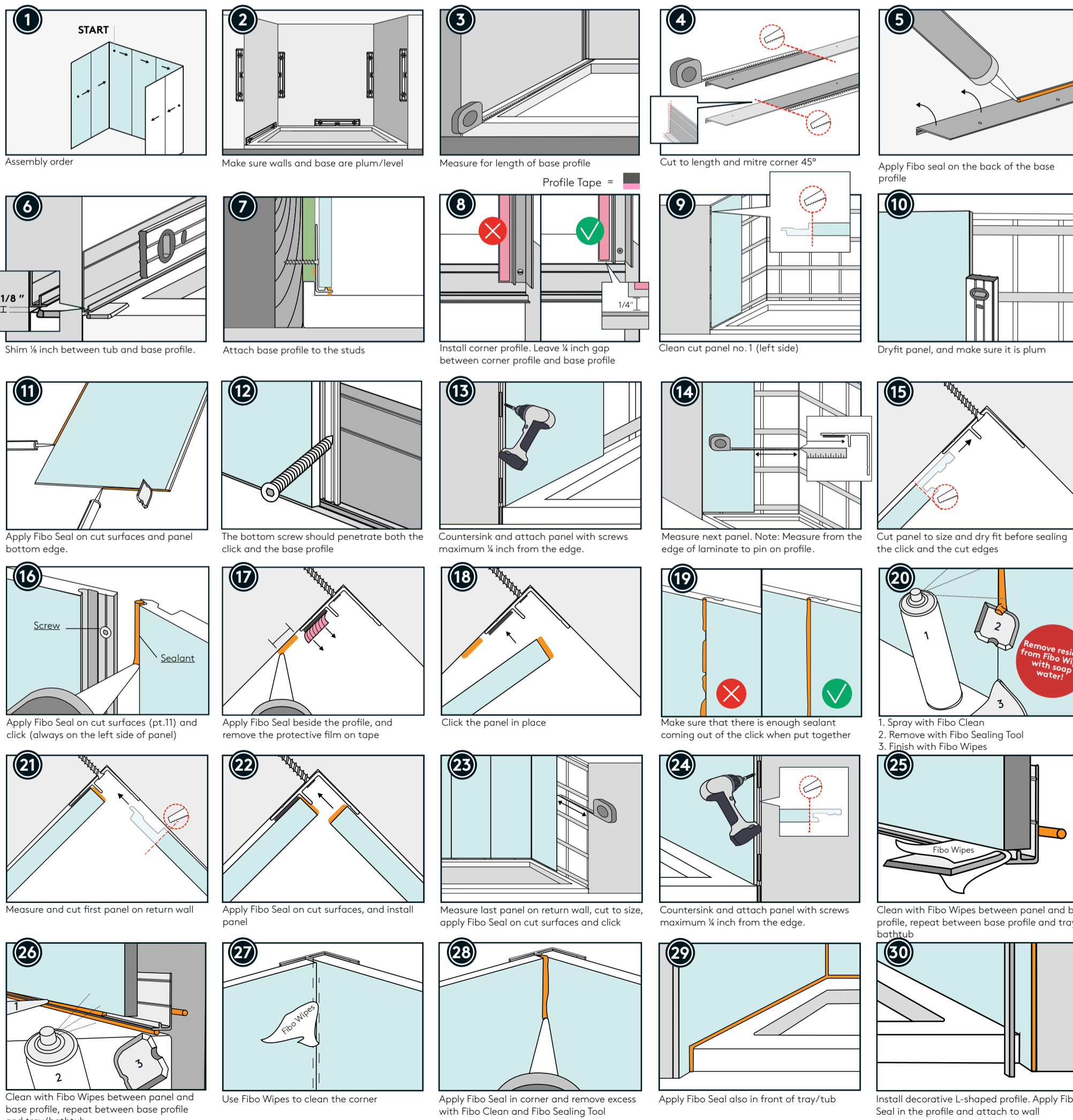

Walls built for life

To ensure that your walls are durable and will last for decades, Fibo wall panels are made from a plywood core layered between a balancing layer and a decorative high pressure laminate that is easy to clean and maintain. Fibo Aqualock makes the installation easy and provide a consistent result. Please visit our webpage for cleaning and maintenance guidance of the system

For å sikre holdbarhet på dine vegger i flere tiår, er Fibo veggpanel produsert med en kerne av kryssfiner mellom balanselaminat i bakkant og et dekorativt høytrykkslaminat i front og som er enkelt å rengjøre og vedlikeholde. Fibo Aqualock gir enkel monteringen og et varig resultat. Besøk nettsiden for instruksjon om Drift, Vedlikehold og Rengjøring (FDV)



Installation videos in both Norwegian and English



Inspiration and installation videos at fibosystem.com /E-mail: info@fibosystem.com
Inspirasjon og monteringsfilmer på fibo.no

Fibo 10 202004

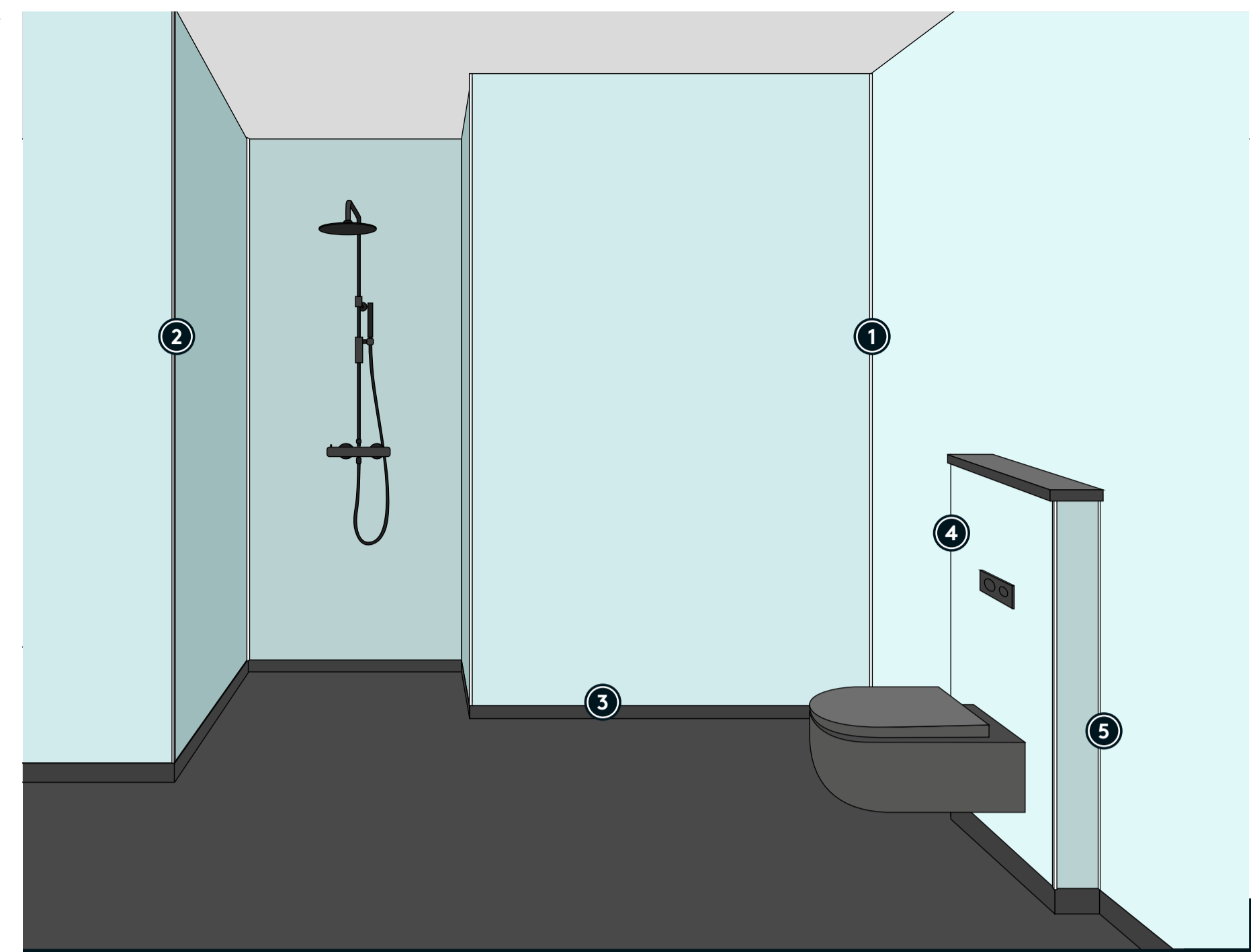

Installation videos in both Norwegian and English

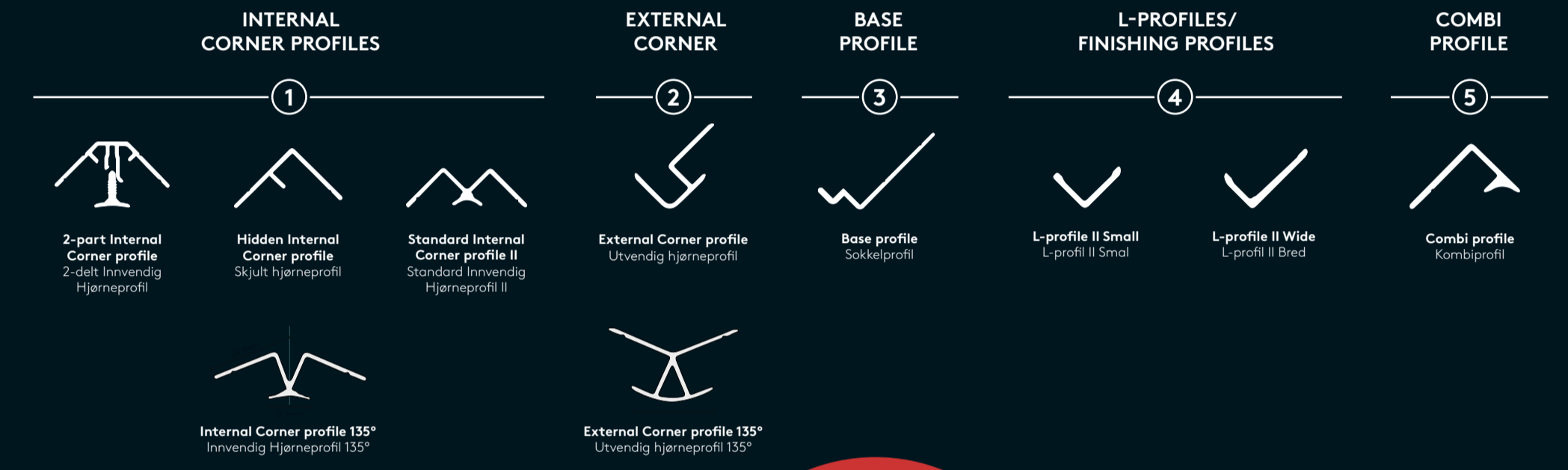

Remove residue from Fibo Wipes immediately with soap water! Vask bort rester fra Fibo Wipes umiddelbart med såpevann!

Fibo replaces vapor barrier when all joints are sealed.

Fibo erstatter dampspærre på yttervegg når alle overganger er forseglet.

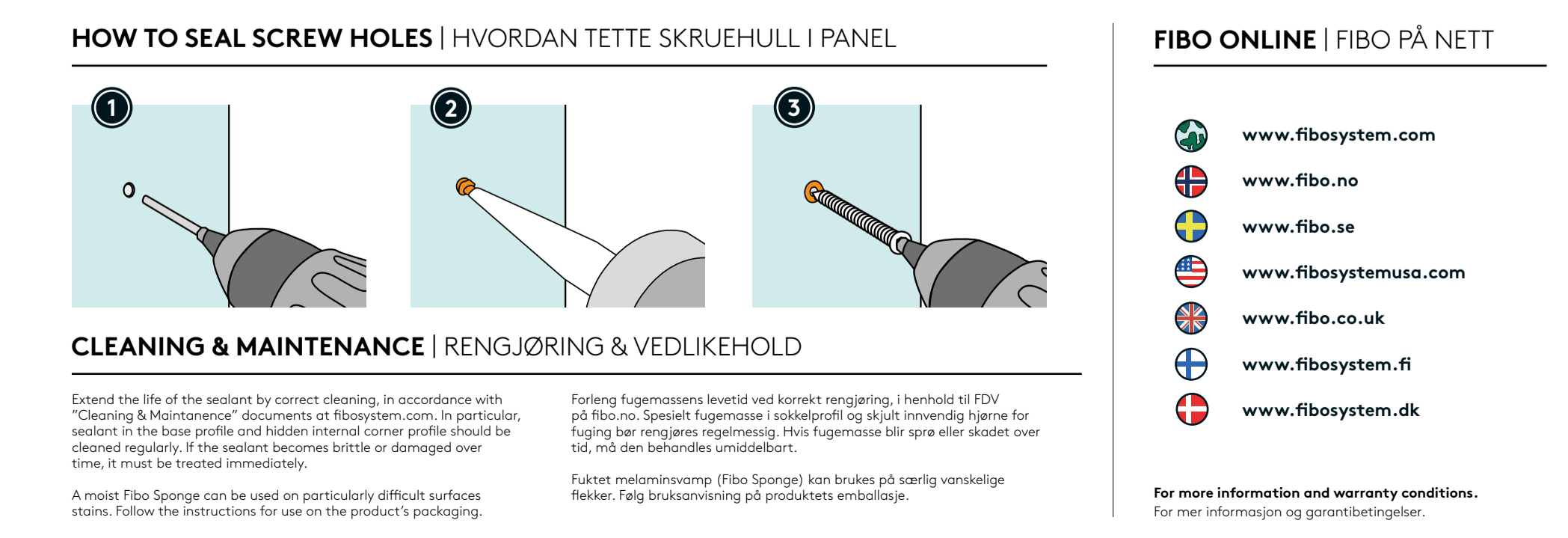
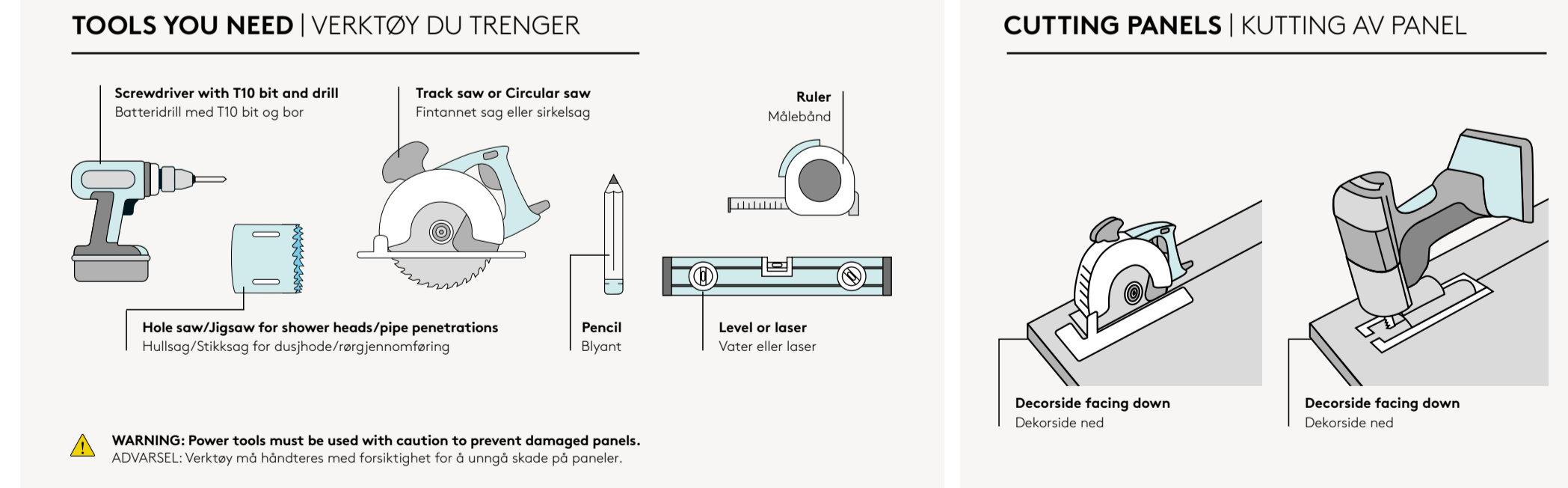

For more information and warranty conditions. For mer informasjon og garantibestegger.



Installation steps 1-5

Monteringssteg 1-5

FIBO SEAL MUST BE USED IN ALL PANEL JOINTS (INCLUDING DRY AREA) TO REDUCE THE RISK OF JOINTS CRACKING OVER TIME.
FIBO SEAL SKAL BENYTTES I ALLE PANELSKJØTER (INKLUDERT TØRRE SONER) FOR Å REDUSERE RISIKO FOR AT TØRKEPREKKER OPPSTÅR OVER TID.

HOW TO PRESEAL AND SEAL FIBO
 For watertight system, apply Fibo Seal as shown beneath. All cut surfaces and bottom edge of panel must be sealed, also when drilling holes for pipe penetration. For best results when sealing base profiles, internal corner profiles, and other visible joints, it is recommended to use masking tape. Make sure to clean all exposed surfaces before sealing. Incorrect installation according to this installation manual will void your warranty and terms of claim.
 Use Fibo Clean and Fibo Wipes to remove excessive sealant. Film from cleaning accessories shall be removed immediately from panel surface.

HVORDAN FORSEGLE OG FUGE FIBO
 For vanntett system, påfør Fibo Seal som vist under. Alle kuttflater og kryssfiner i bunnen av panel skal forsegles - også ved hulltakning til rør gjennomføring. For best resultat ved fuging av sokkelprofil, innvendig hjørneprofil og andre synlige fuger anbefales det bruk av maskeringsstape. Sørg for å rengjøre alle overflater før fugemasse påføres. Ved mangelfull montering iht. denne monteringsanvisningen bortfaller garanti og reklamasjonstett. Bruk Fibo Clean og Fibo Wipes for å fjerne overflødig fugemasse. Film fra rengjøringsstøper skal fjernes umiddelbart fra panelede.

HOW TO SMOOTHEN THE CLICK LOCK WITH FIBO CLICK-WAX
 If the click joint is challenging to assemble, we recommend using Fibo Click Wax as shown beneath to facilitate the installation.

HVORDAN SMØRE KLIKKLÅSEN MED FIBO CLICK-WAX
 Dersom klikklåsen oppleves skjær under monteringen, anbefales bruk av Fibo Click Wax på panelet som vist under, for å forenkle monteringen.

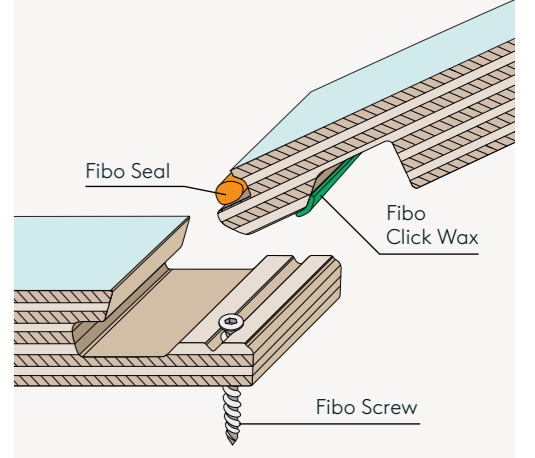
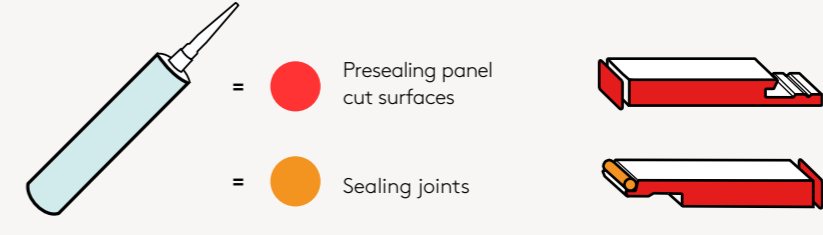

1 BACKWALL OPTIONS

VELG RIKTIG BAKVEGG

Extra support in backwall must be used if heavy objects such as cabinets, toilets, shower seats, support handles or similar is to be installed. Flatness tolerance: Maximum flatness deviation of +/-2 mm/2 meters. There is no need for extra membrane behind our wall panels.

Benytt ekstra støtte i bakvegg dersom det skal monteres tunge gjenstander som skap, toalett, dusjsete, støttehåndtak eller lignende. Planhetstoleranse: Maksimalt planhetssavvik på +/-2 mm/2 meter. Det er ikke behov for dampsperre eller membran bak veggpanelene.



When installed on concrete or brick walls with screws, the panels shall be fixed to vertical and horizontal battens with dimensions min. 23 mm x 48 mm. The battens shall be installed c/c 0,8 m with the wide side flat, with a capillary abstracting layer between the inner battens and the concrete wall.

Ved montering på betong- eller teglvegger med skruer skal panelene festes til vertikale og horisontale lekter med dimensjoner min. 23 mm x 48 mm. Lekterne skal monteres c/c 0,8 m med bred side mot vegg, med kapillært bindende lag mellom de inneste lekterne og betongveggen.

Fibo Adhesive

When gluing panel to a concrete wall, make sure the back wall is dry (RH<85%/CM<2%), even and dust free. Place panel into position and secure with pressure. Make sure to screw the first panel as shown. In the UK it is allowed to glue on tiles. Check national building regulations for more.

Fibo Seal in combination with screws, or glue with initial grab. Make sure to screw the first panel as shown.

Ved liming av panel til vegg av betong, sørg for at veggen er tørr (RH<85%/CM<2%), jevn og rengjort. Husk skruer på første panel - se figur.

2 SOLUTIONS FOR APERTURES FOR PIPES

LØSNINGER FOR RØRGJENNOMFØRING

Cutting surfaces must be sealed when drilling holes for pipe penetration. For complete installation guidance, follow the wall base producer's instructions. The ones illustrated are EAD 030437-00-0503 approved systems. Approval for PP- and copper pipes is documented through SINTEF Technical Approval Z289.

Kuttflater skal forsegles ved hulltakning til rør gjennomføring. For fullstendig monteringsanvisning se EAD 030437-00-0503 godkjente løsninger, følg vegglokk produsentens anvisninger. Godkjenning av PP- og kobberrør er dokumentert i SINTEF Teknisk Godkjenning Z289.

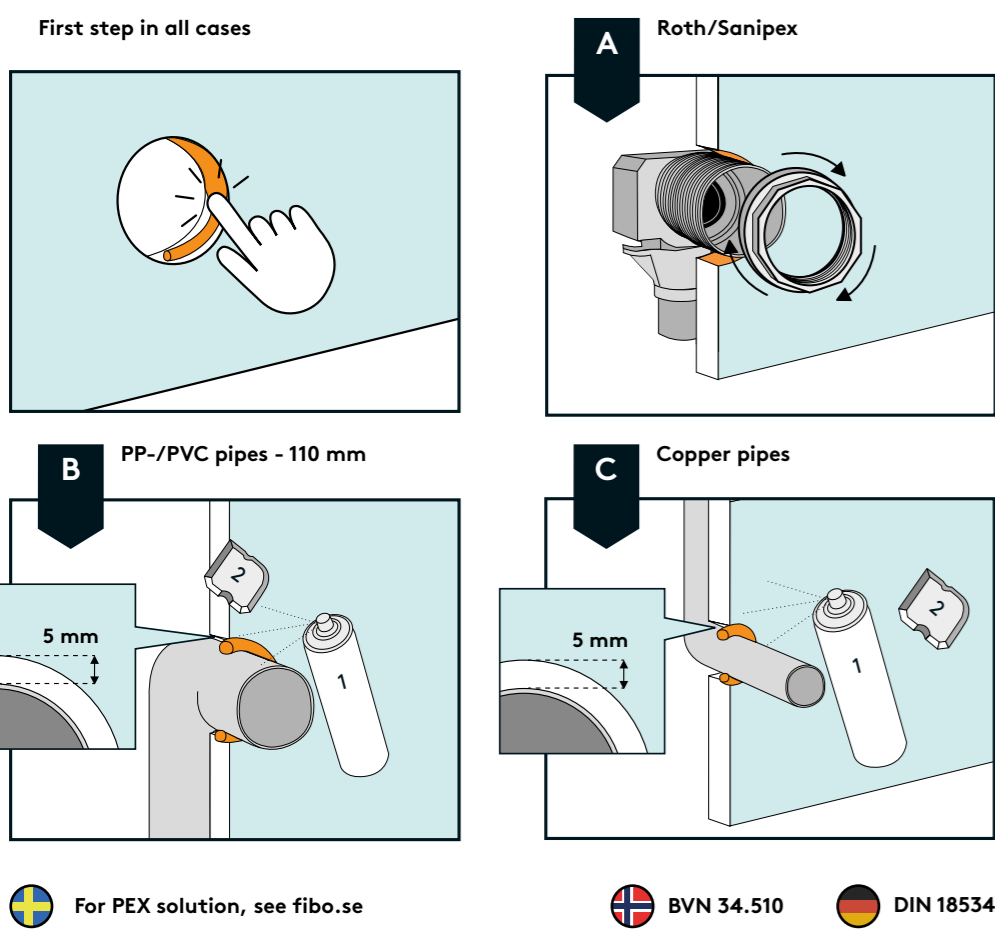

For PEX solution, see fibose

BNV 34.510

DIN 18534

3 SEALING FINISH, STACKING PROFILE AND EXTERNAL CORNER PROFILE

AVSLUTNING MOT TAK, SKJØTEPROFIL OG UTVENDIG HJØRNEPROFIL

Fibo Seal

*Not available in the UK

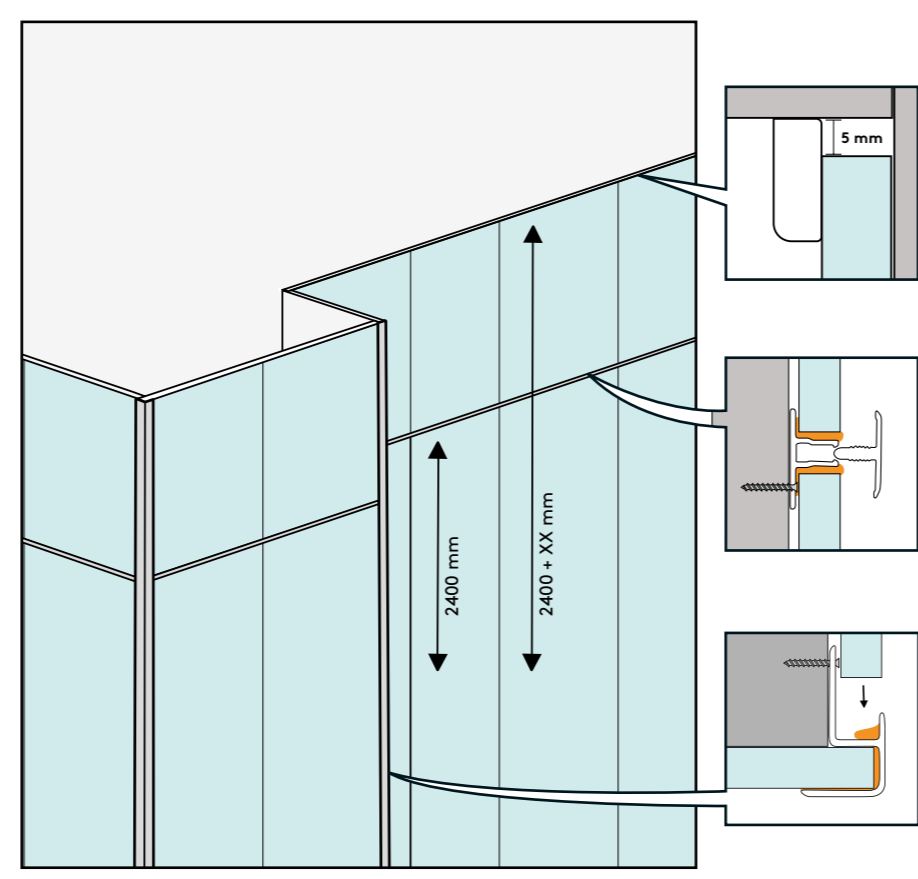

4 CHOOSE TRANSITION TO FLOOR MEMBRANE

AVSLUTNING MOT GULVMEMBRAN

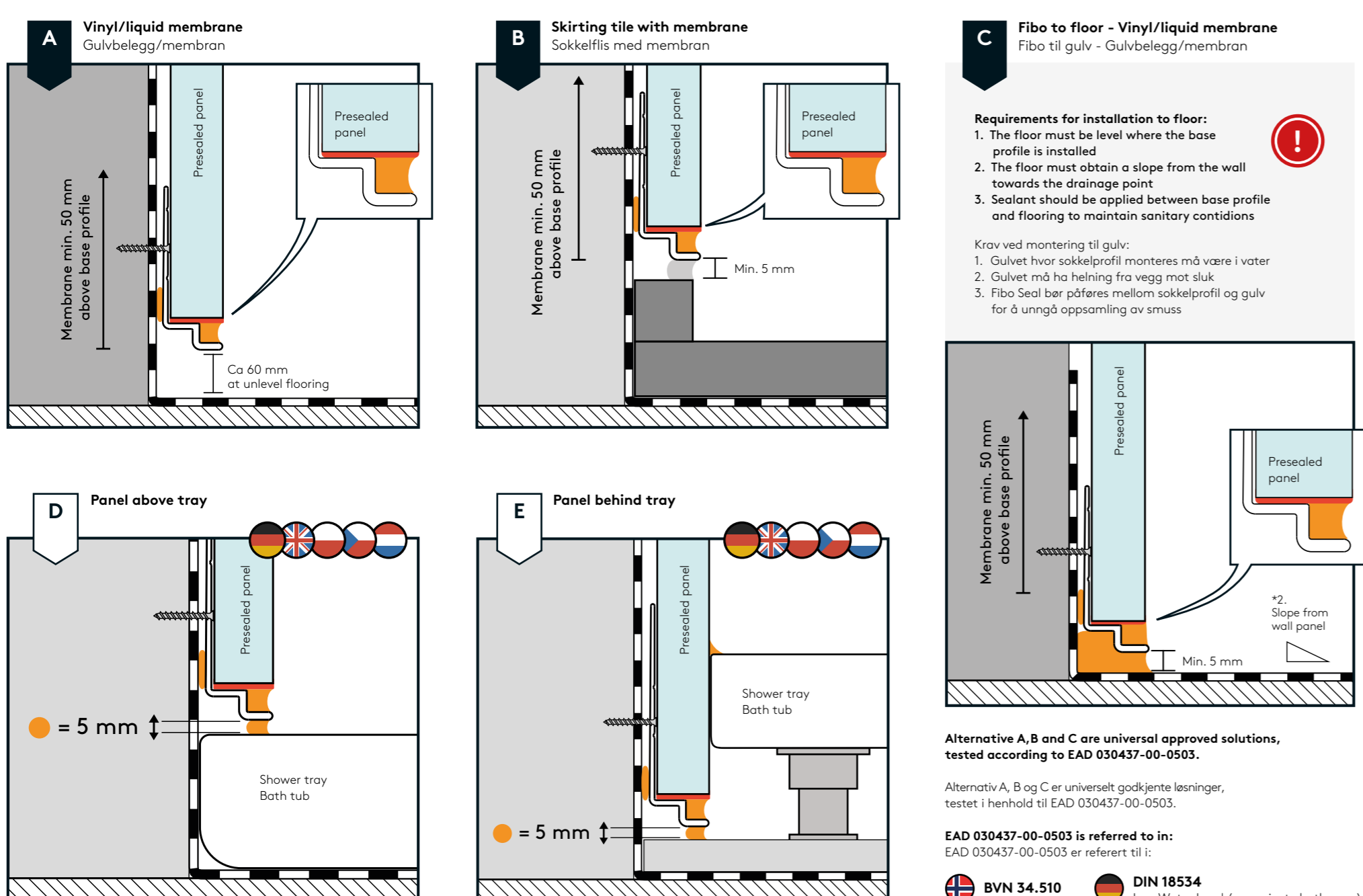

Requirements for installation to floor:
 1. The floor must be level where the base profile is installed.
 2. The floor must obtain a slope from the wall towards the drainage point.
 3. Sealant should be applied between base profile and flooring to maintain sanitary conditions.

Krav ved montering til gulv:
 1. Gulvett hvor sokkelprofil monteres må være i vater.
 2. Gulvet må ha hellning fra vegg mot sluk.
 3. Fibo Seal bør påføres mellom sokkelprofil og gulv for å unngå oppsamling av smuss.

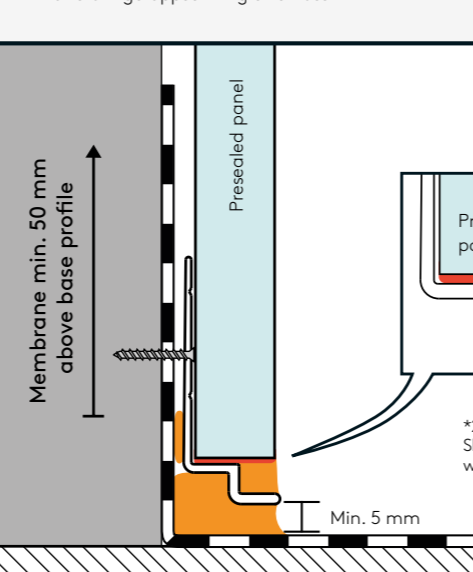

Alternative A, B and C are universal approved solutions, tested according to EAD 030437-00-0503.

Alternativ A, B og C er universelt godkjente løsninger, testet i henhold til EAD 030437-00-0503.

EAD 030437-00-0503 is referred to in: EAD 030437-00-0503 er referert til:

BNV 34.510 DIN 18534 Low Water Load (e.g. private bathroom)

5 CHOOSE PREFERRED CORNER PROFILE A, B OR C

VELG HJØRNEPROFIL A, B ELLER C

A 2-PART INTERNAL CORNER PROFILE*

2-DELT INNVEDIG HJØRNEPROFIL

* Not available in the UK

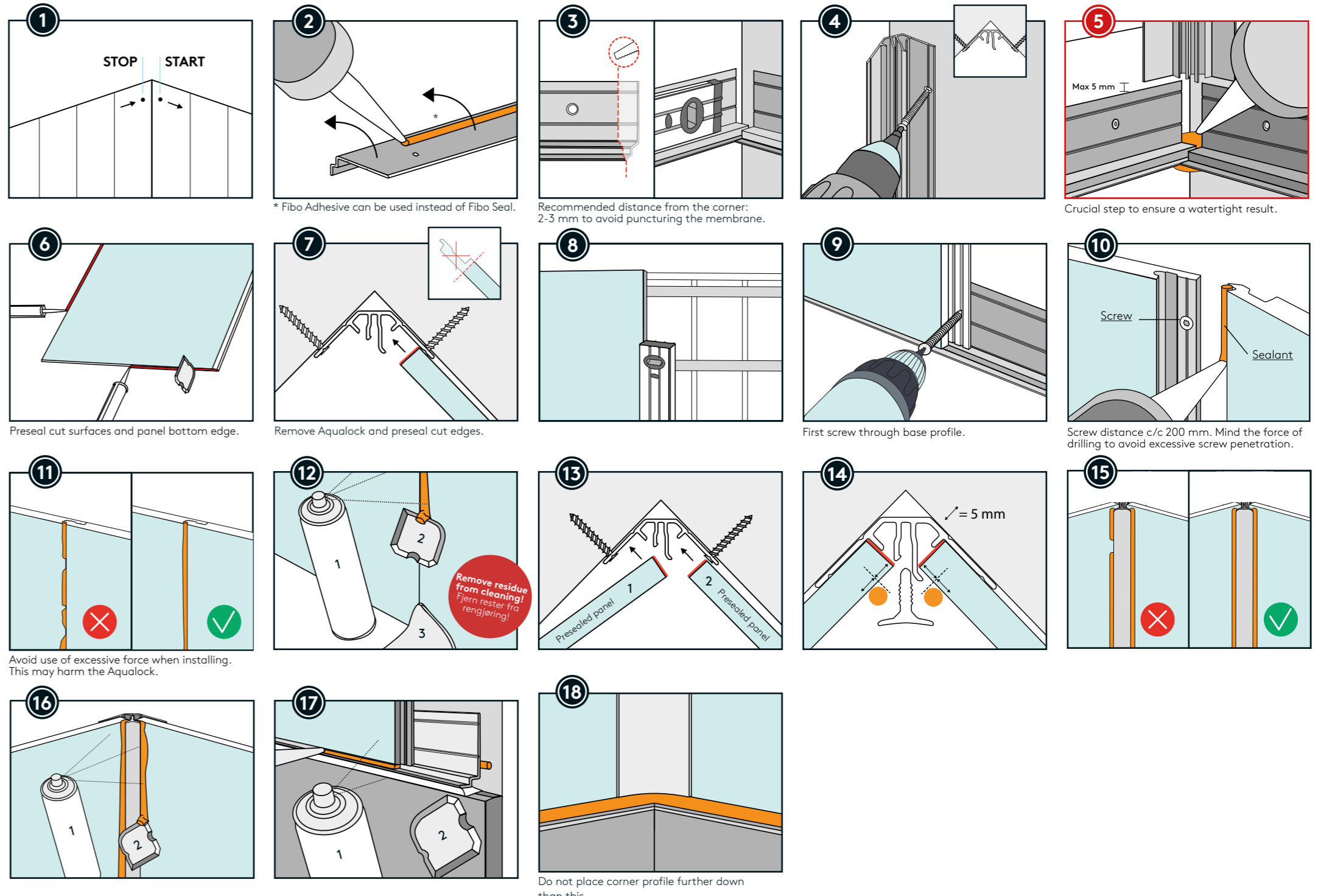

B HIDDEN INTERNAL CORNER PROFILE

SKJULT HJØRNEPROFIL

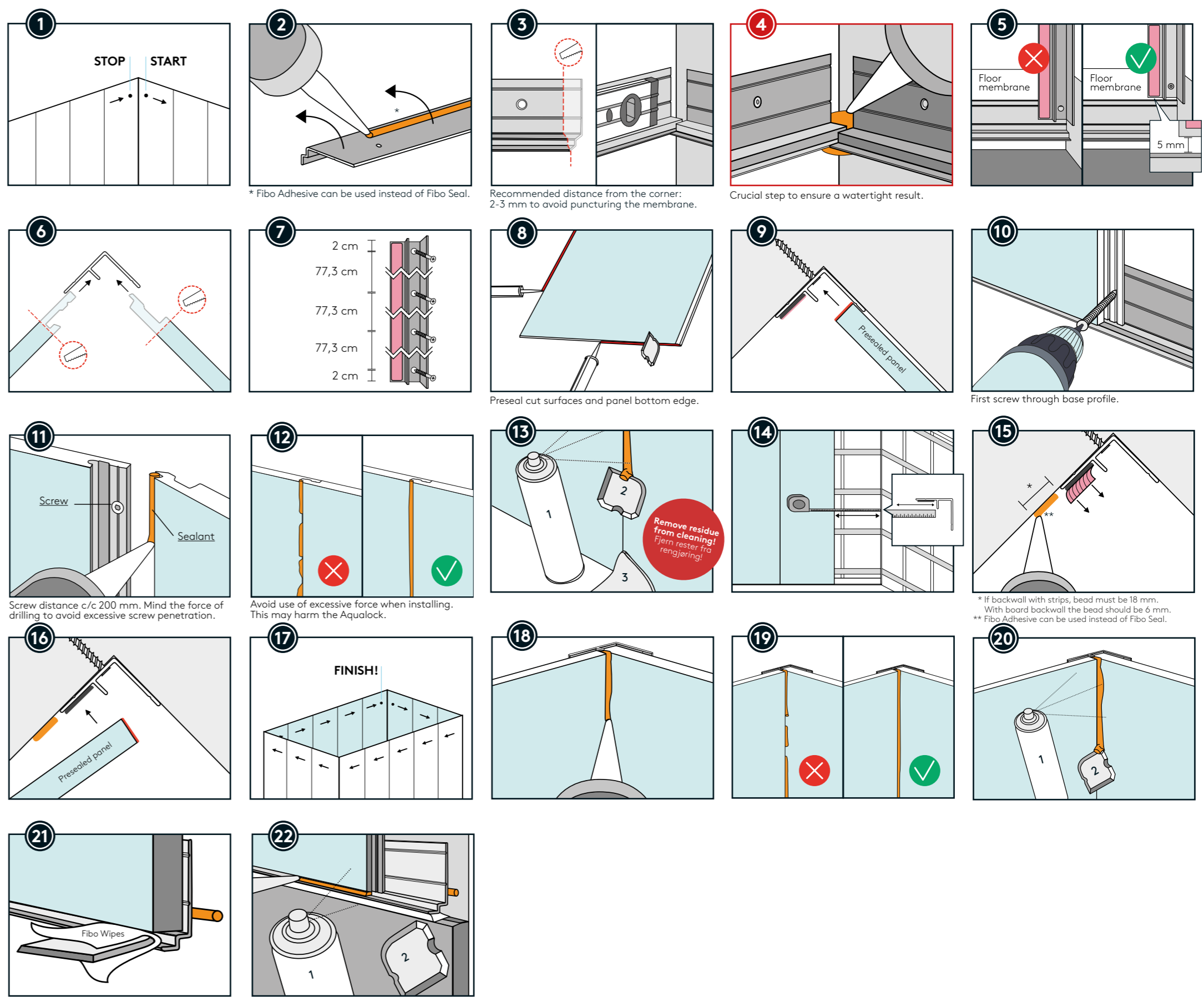

C STANDARD INTERNAL CORNER PROFILE

STANDARD INNVEDIG HJØRNEPROFIL

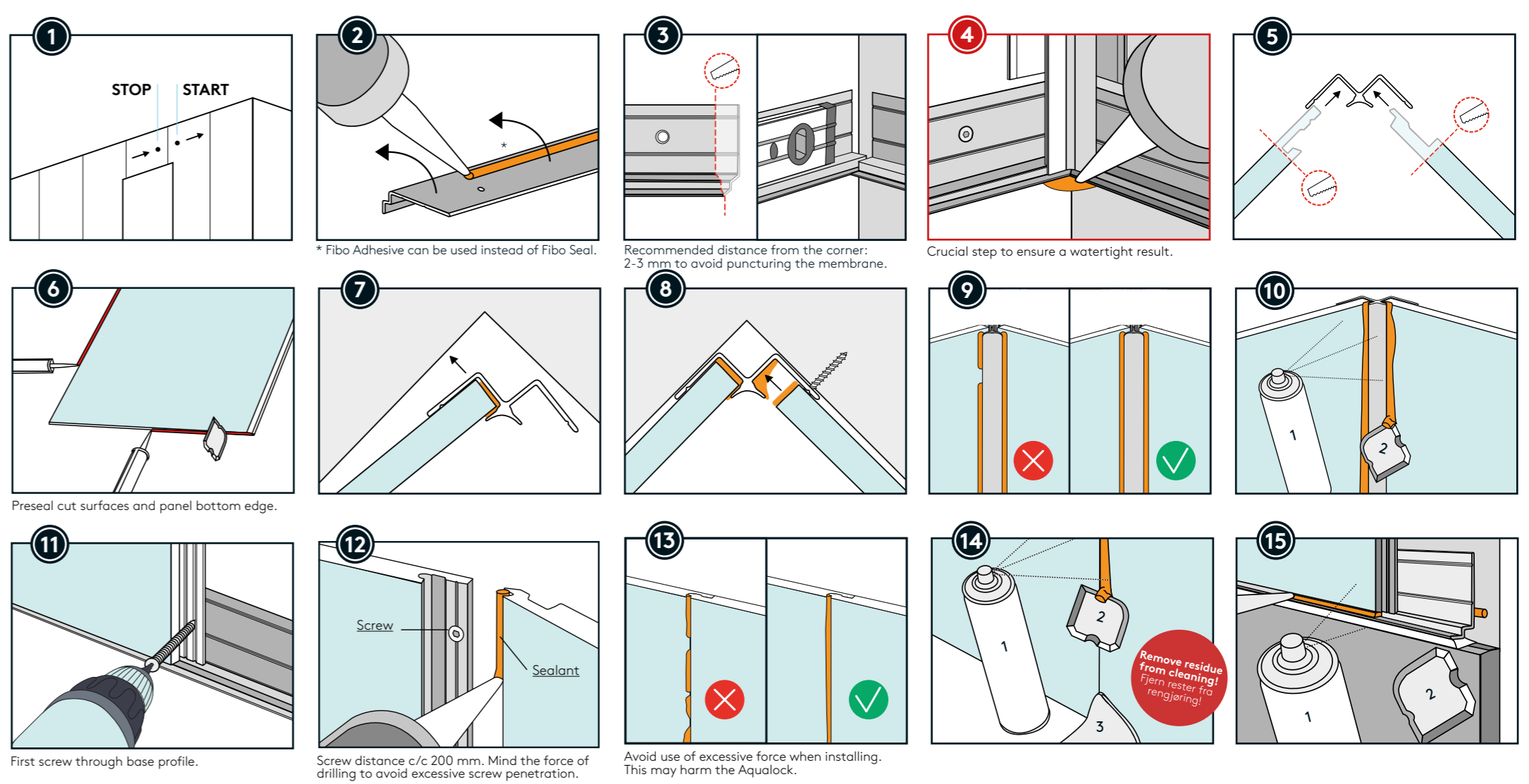

REMEMBER! Always clean panels with neutral detergent after installation. This is important to achieve the best result. Extra difficult spots can be removed with Fibo Clean together with Fibo-Sponge. HUSK! Vask alltid panelede med nøytralt vaskemiddel etter monteringen. Dette er viktig for best mulig slutresultat. Ekstra vanskelige flekker kan fjernes med Fibo Clean og Fibo-Svamp.

NB: It is recommended to use a cradling movement back and forth when clicking the panels together to ensure a good joining of the Aqualock. Using Fibo Grip will give increased control during joining. If necessary, you can carefully tap the nail pin on the right side of the panel with the Fibo Tapping Tool to ensure that the panel is completely locked. NB: Det anbefales bruk av vuggende bevegelse når man klikker panelede sammen for å sikre en god sammenføyning av Aqualock. Bruk av Fibo Grip vil gi økt kontroll under sammenføyning. Ved behov kan man slå forsiktig med spikerleppen på høyre side av panelet med Fibo Tapping Tool for å sikre at panelet er helt låst.