

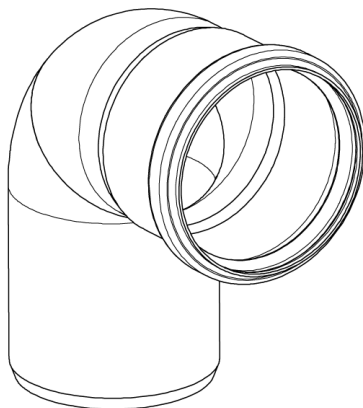

BEND 87.5°, Ø75MM  
- Syrefast stål: AISI316L/EN1.4404

Type nr.: 820.090.075 S  
EAN nr.: 5705499401417  
VVS nr.: 160201375  
RSK nr.: 1550286  
NRF nr.: 2170765  
LVI nr.: 0250833

Type: Bend  
Utløpsdia. (mm): 75  
Vinkel (°): 87,5  
Vekt (kg): 0,39  
Materiale: AISI 316L  
Materiale: EN 1.4404

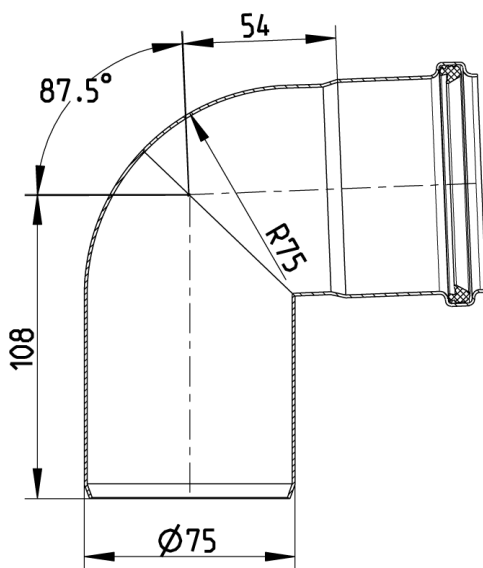

### Godkjenninger

ABS - 04-LD472768/3

Achilles - 25316-17

AUS - WMKT00204 - 18

Bureau Veritas - 02375-G0

DE - LGA Certificate 57214035 a

DK - VA 2.12/19349-16

DNV - TAP0000023-rev1

FR - DTA 14/12-1811\*V1 EuroPipe

Lloyds Register 92-00041 (E6)

MARINE - R4547 NATO CODIFICATION SYSTEM

NO - 0692-12

PL - Hygenic Certificate - All products

RINA - MAC128714XG EuroPipe

RS - 14.10112.262

RU - 1682258

SE - SITAC 4423/90

UK - BBA 86-1751 EuroPipe

UR - 1055745

US - IAPMO File No.3247-16