



## Produkt-/FDV-dokumentasjon

NRF-nr.	Artikkelnavn
9720253	Rørfot enløper Ø60mm

-  Rørfot i galvanisert stål
-  Meget solid utførelse

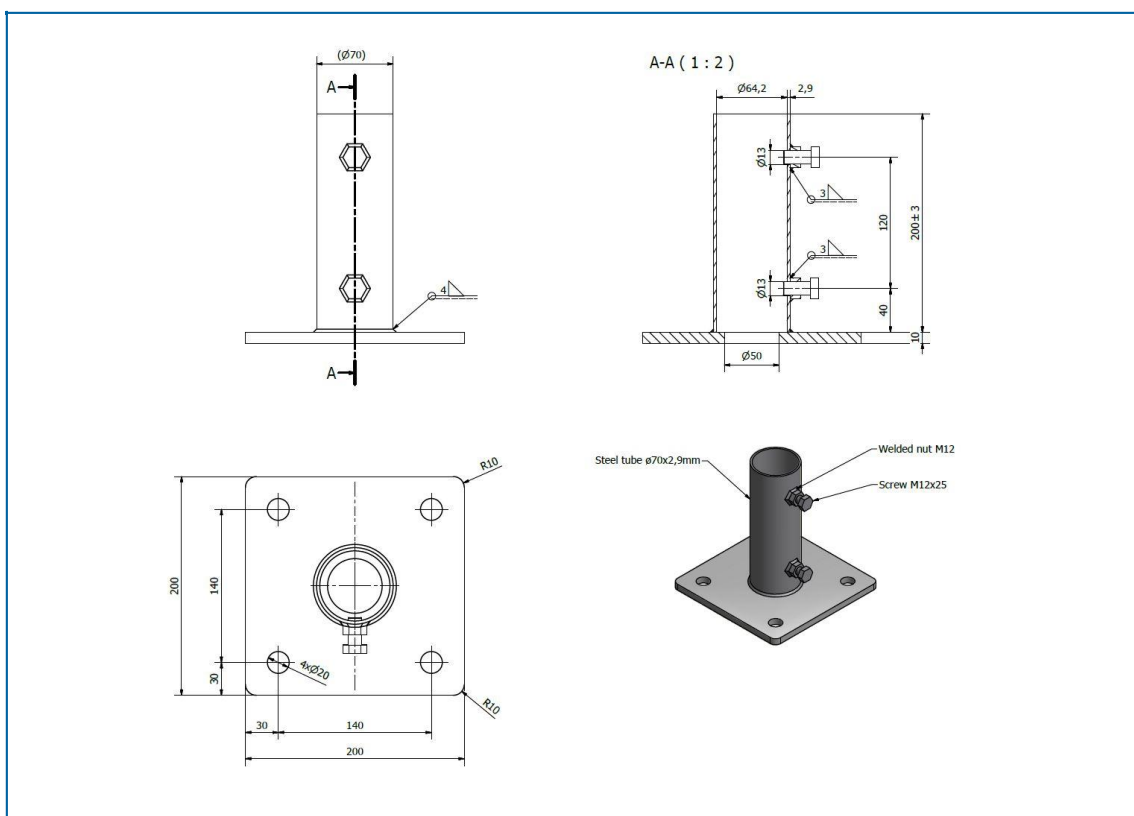

### Fysiske data

Vekt: 4 kg    Lengde: 200,00 mm





Volum: 8,4 dm<sup>3</sup>    Brekke: 200,00 mm

Høyde: 210,00 mm

-  M12 bolter

2020-08-21  
Rev.nr.: 1.1

### ***Teknisk beskrivelse***

-  Fotplate 200x200x10mm
-  20mm hull
-  Rør Ø70x3mm høyde 200mm
-  2 stk M12 strammeskruer. 19mm hode
-  Galvanisert

### ***Monteringsanvisning***

Man trenger 1 stk 19mm fastnøkkel evt skiftenøkkel for å montere stolpen i foten.  
Ved montering rørfot på fundament trenger man 1 stk 24mm fastnøkkel evt skiftenøkkel.

### ***Vedlikehold og avfallsinstruks***

Intet vedlikehold er påkrev for dette produkt.  
Leveres offentlig deponi som Metallavfall etter endt bruk

### ***Tilhørende produkter***

NRF-nr.	Artikkelnavn
9720255	Betongfundament enløper 190kg