

Monteringsvejledning

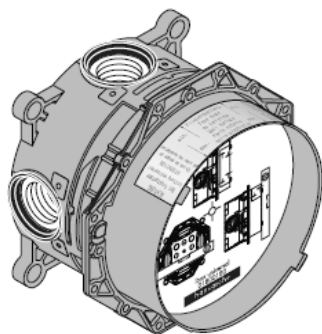

ibox universal

hansgrohe

Kararmaturer

| | |
|------------------|-------------------|
| Starck | 10415XXX/10416XXX |
| Starck X | 10445000 |
| Massaud | 18455000 |
| Carlton | 17415XXX |
| Steel | 35425800 |
| Terrano | 37455XXX |
| Uno | 38405XXX/38415XXX |
| Uno ² | 38425XXX |
| Citterio | 39455XXX |
| Citterio M | 34425000 |
| Metropol E | 14475000 |
| Metris E | 31475000 |
| Focus E | 31744000 |

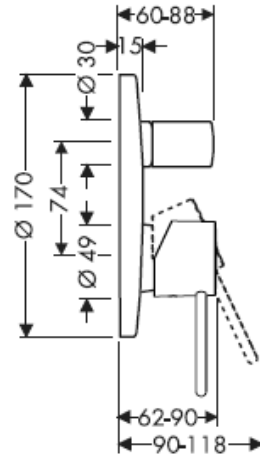

Kararmatur med integreret sikkerhedskombination.

| | |
|------------------|-------------------|
| Starck | 10417XXX/10418XXX |
| Starck X | 10447000 |
| Massaud | 18457000 |
| Carlton | 17417XXX |
| Steel | 35427800 |
| Terrano | 37417XXX |
| Uno | 38407XXX/38417XXX |
| Uno ² | 38427XXX |
| Citterio | 39457XXX |
| Citterio M | 34427000 |
| Metropol E | 14477000 |
| Metris E | 31476000 |

Brusearmaturer

| | |
|------------------|-------------------|
| Starck | 10615XXX/10616XXX |
| Starck X | 10645000 |
| Massaud | 18655000 |
| Carlton | 17615XXX |
| Steel | 35625800 |
| Terrano | 37655XXX |
| Uno | 38605XXX/38615XXX |
| Uno ² | 38625XXX |
| Citterio | 39655XXX |
| Citterio M | 34625000 |
| Metropol E | 14675000 |
| Metris E | 31675000 |
| Focus E | 31761000 |

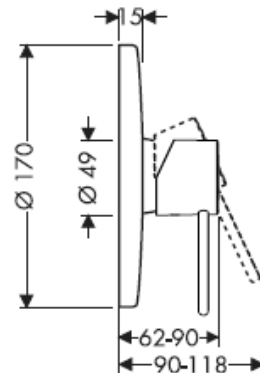

Kararmaturer

| | |
|--------------------------------|----------|
| Metropol S | 14465000 |
| Metris S | 31465000 |
| Talis S / Talis S ² | 32475000 |
| Talis E ² | 31645000 |
| Talis Classic | 14145XXX |
| Focus S | 31743000 |

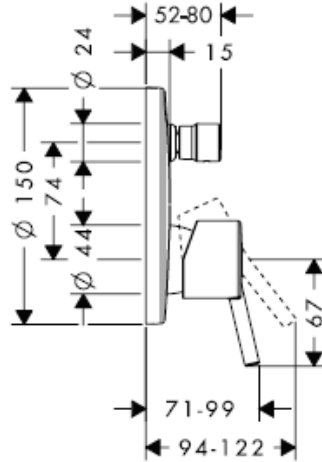

Kararmatur med integreret sikkerhedskombination.

| | |
|--------------------------------|----------|
| Metropol S | 14466000 |
| Metris S | 31466000 |
| Talis S / Talis S ² | 32477000 |
| Talis E ² | 31646000 |
| Talis Classic | 14146XXX |

Brusearmaturer

| | |
|--------------------------------|----------|
| Metropol S | 14665000 |
| Metris S | 31665000 |
| Talis S / Talis S ² | 32675000 |
| Talis E ² | 31666000 |
| Talis Classic | 14165XXX |
| Focus S | 31763000 |

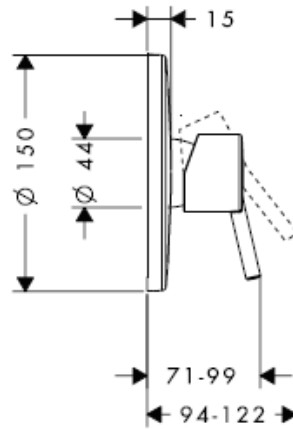

Termostat High Flow

| | |
|---|----------|
| Metropol E + S / | |
| Metris E + S | |
| Focus E + S | |
| Talis E ² + S + S ² + Classic | 15715XXX |
| Raindance Royale | |
| High Flow Set | 27070000 |

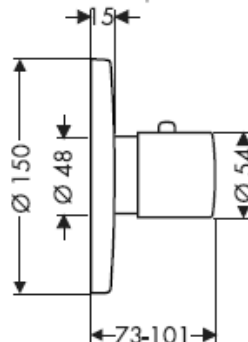

Termostat

| | |
|--|-------------------|
| Starck | 10710XXX |
| Starck X | 10716000 |
| Massaud | 18740000 |
| Carlton | 17710XXX/17715XXX |
| Steel | 35710800 |
| Terrano | 37710XXX/37715XXX |
| Montreux | 16810XXX |
| Uno / Uno ² | 38375XXX |
| Citterio | 39710XXX/39715XXX |
| Citterio | 34715000 |
| Metropol E + S/Metris E + S/ | |
| Talis E ² + S + S ² + Classic/ | |

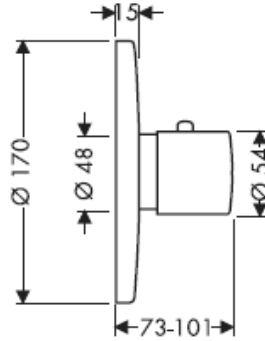

Termostat High Flow

| | |
|------------------------|-------------------|
| Starck | 10715XXX |
| Starck X | 10717000 |
| Massaud | 18741000 |
| Carlton | 17712XXX/17716XXX |
| Steel | 35715800 |
| Terrano | 37711XXX/37716XXX |
| Montreux | 16815XXX |
| Uno / Uno ² | 38715XXX |
| Citterio | 39711000/39716000 |
| Citterio M | 34716000 |

Brusetermostat med elektronisk start-/stopknap.

15740XXX

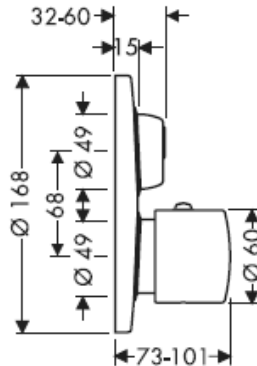

Termostat med afspæringsventil

| | |
|---|-------------------|
| Starck | 10700XXX |
| Starck X | 10706000 |
| Massaud | 18745000 |
| Carlton | 17700XXX/17705XXX |
| Steel | 35700800 |
| Terrano | 37700XXX/37705XXX |
| Montreux | 16800XXX |
| Uno / Uno ² | 38700XXX |
| Citterio | 39700000/39705000 |
| Citterio M | 34705000 |
| Metropol E + S/Metris E + S/ | |
| Focus E + S | |
| Talis E ² + S + S ² + Classic | |
| | 15700XXX |

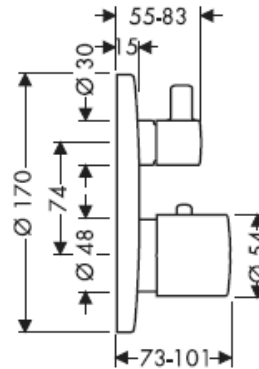

Termostat med afspæringsventil og omskifter

| | |
|---|-------------------|
| Starck | 10720XXX |
| Starck X | 10726000 |
| Massaud | 18750000 |
| Carlton | 17720XXX/17725XXX |
| Steel | 35720800 |
| Terrano | 37720XXX/37725XXX |
| Montreux | 16820XXX |
| Uno / Uno ² | 38720XXX |
| Citterio | 39720XXX/39725XXX |
| Citterio M | 34725000 |
| Metropol E + S / Metris E + S/ | |
| Focus E + S / | |
| Talis E ² + S ² + S + Classic | |
| | 15720XXX |

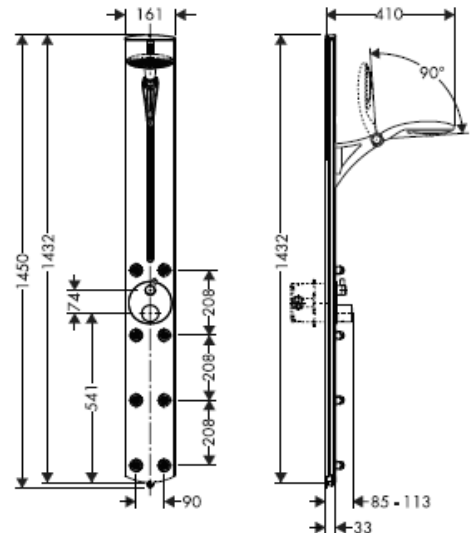

Raindance brusepanel

27100XXX

Termostat med afspæringsventil og omskifter (se s. 12, 22, 24, 34)

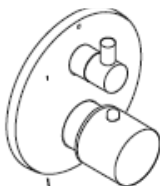

Termostat (se s. 26, 28, 32, 36, 38)



Brusetermostat med elektronisk start-/stopknap. (se s. 20)



Termostat High Flow (se s. 42 - 60)



Termostat med afspæringsventil (se s. 14, 16, 18, 30)

Kararmaturer (se s. 12)

Rainfall
(se s. 56)

Brusearmaturer (se s.14 -20)

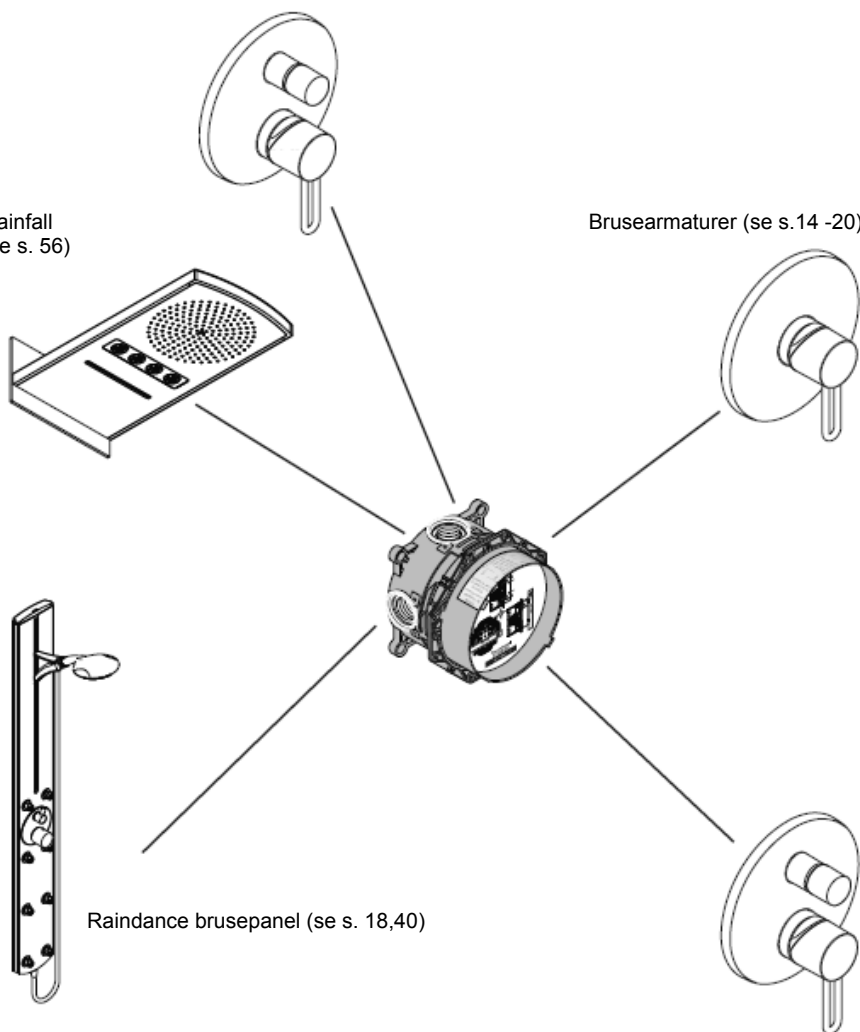

Raindance brusepanel (se s. 18,40)

Kararmatur med integreret sikkerhedskombination. (se s. 10)

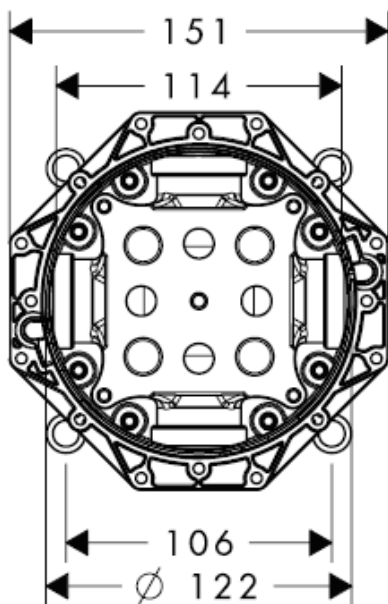

I-boxens grundkrop er universel – kan monteres horisontalt og vertikalt. Undtagelsen er dog ved montering af kar/brusearmaturet med integreret sikkerheds-kombination, her er kun den vertikale montering mulig.

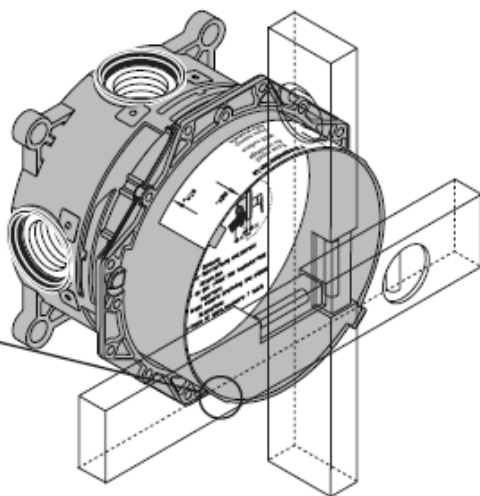
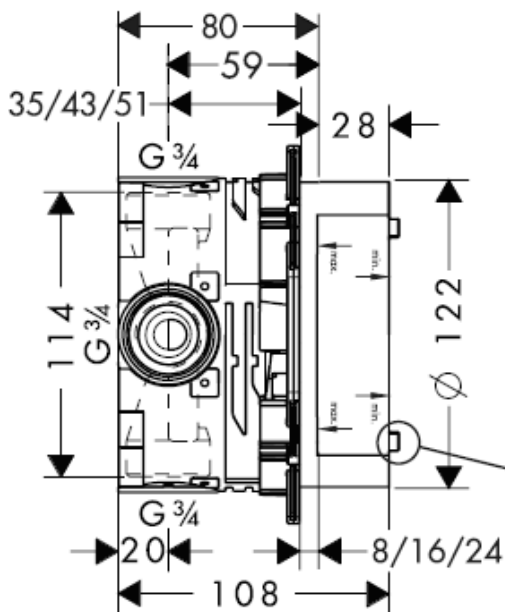

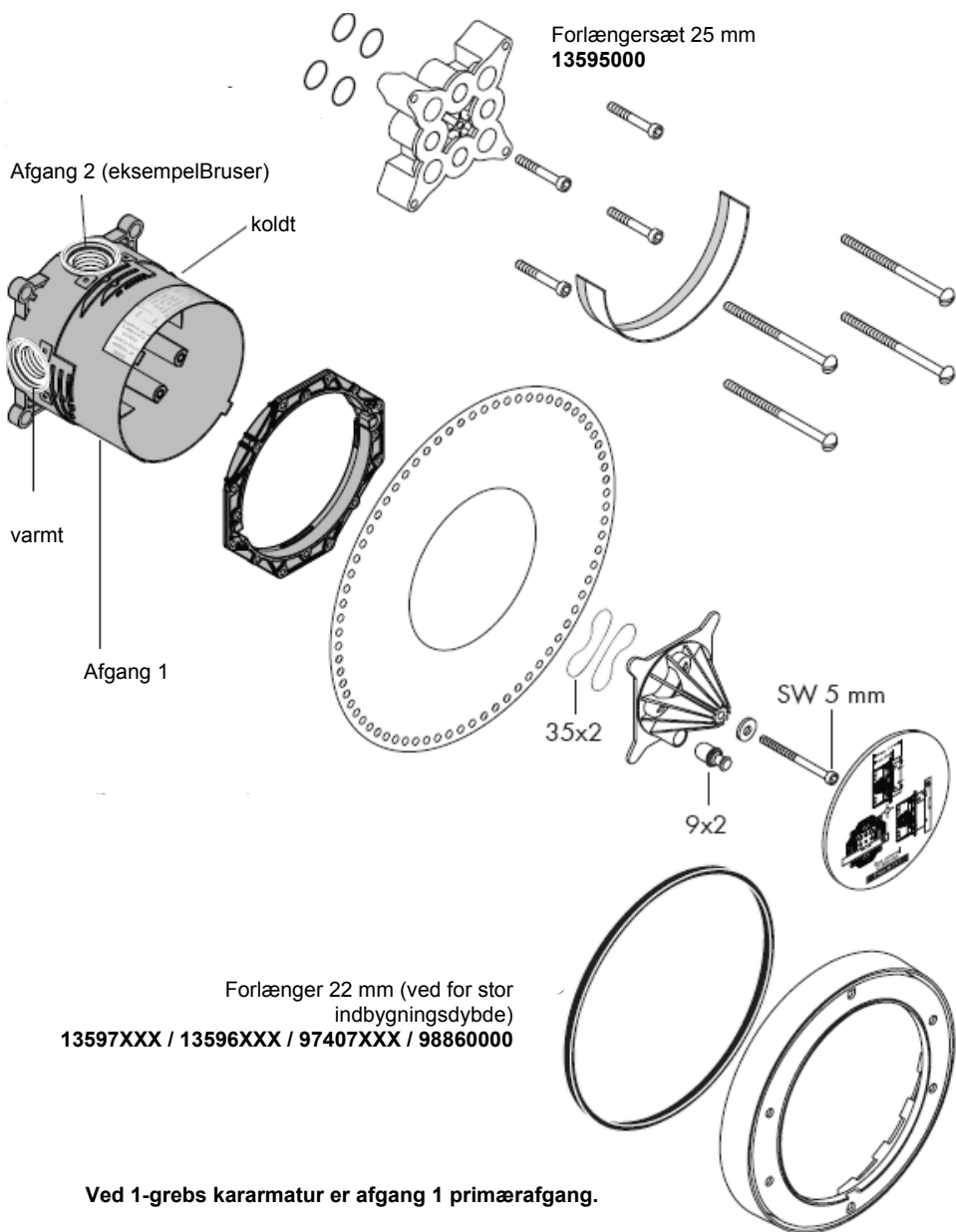

Kararmatur med integreret sikkerhedskombination.

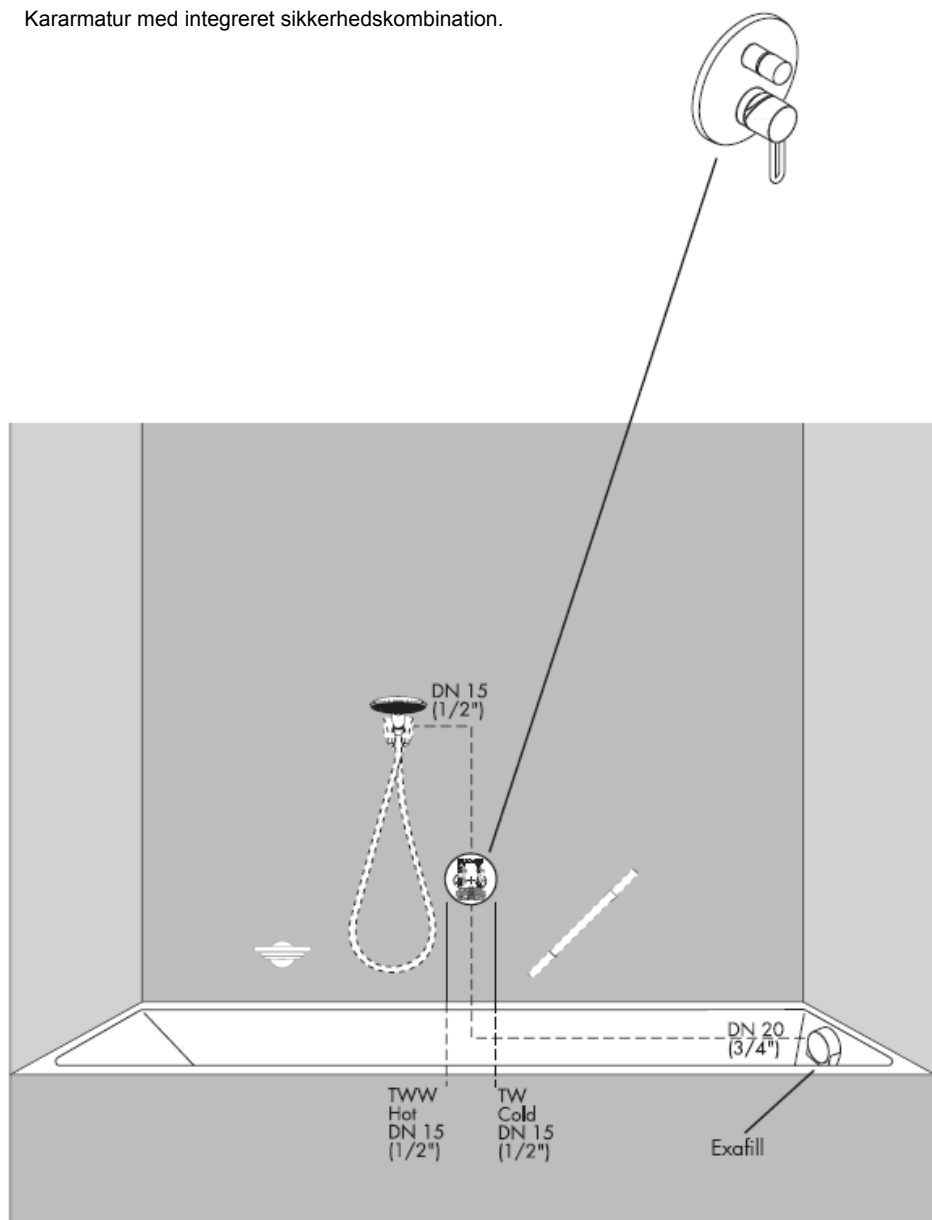

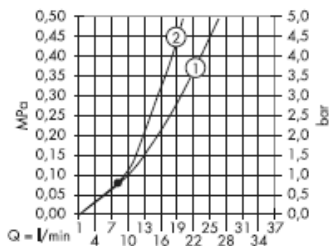

Hvis der foreligger en defekt, kan der udræde vand på sikkerhedskombinationen!

Fra • er funktionen anvendelig.

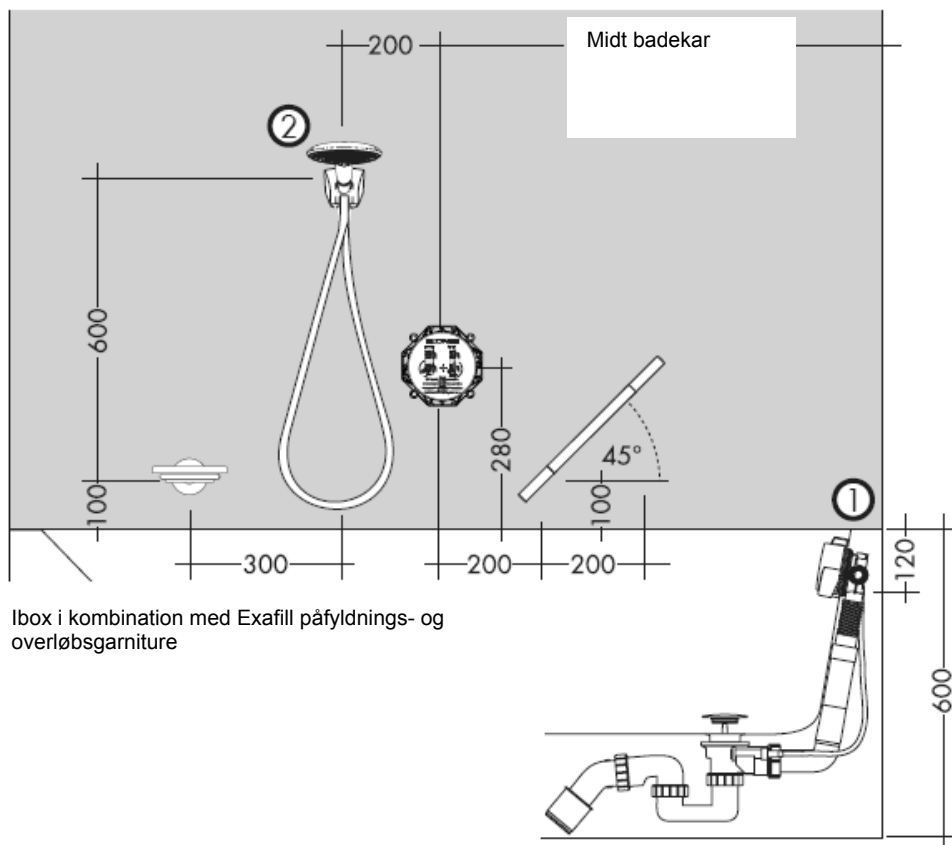

Ibox i kombination med Exafill påfyldnings- og overløbsgarnture

Termostat med afspæringsventil og omskifter

Kararmaturer

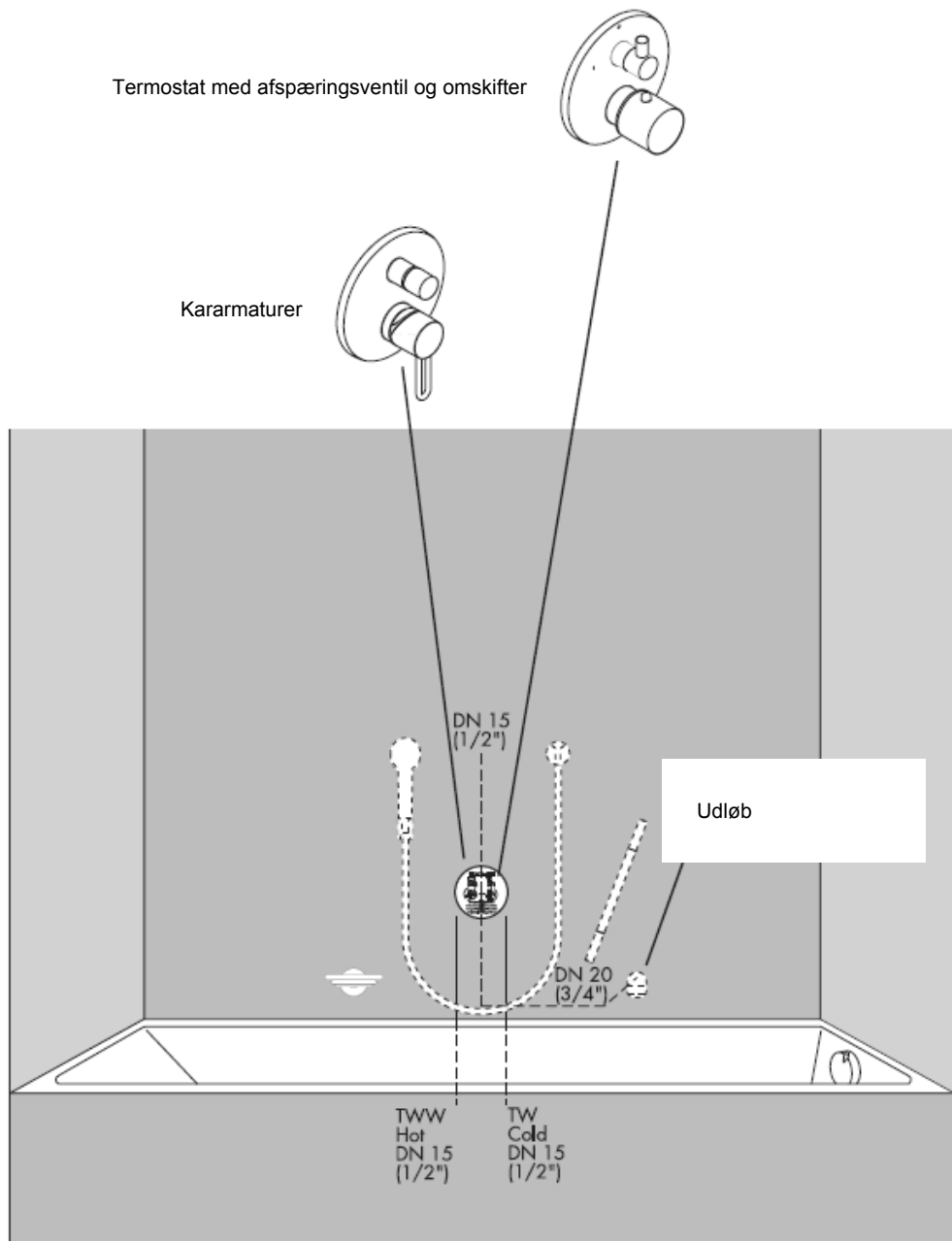

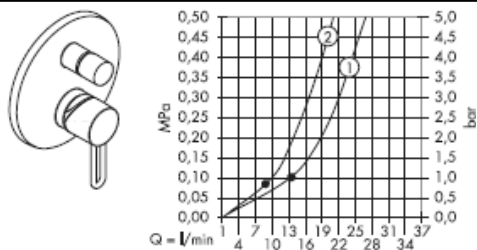
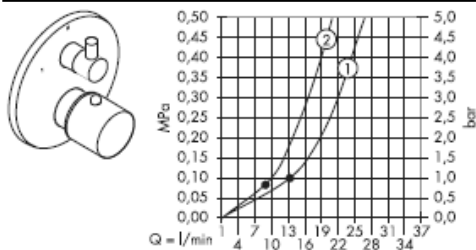

Fra • er funktionen anvendelig.

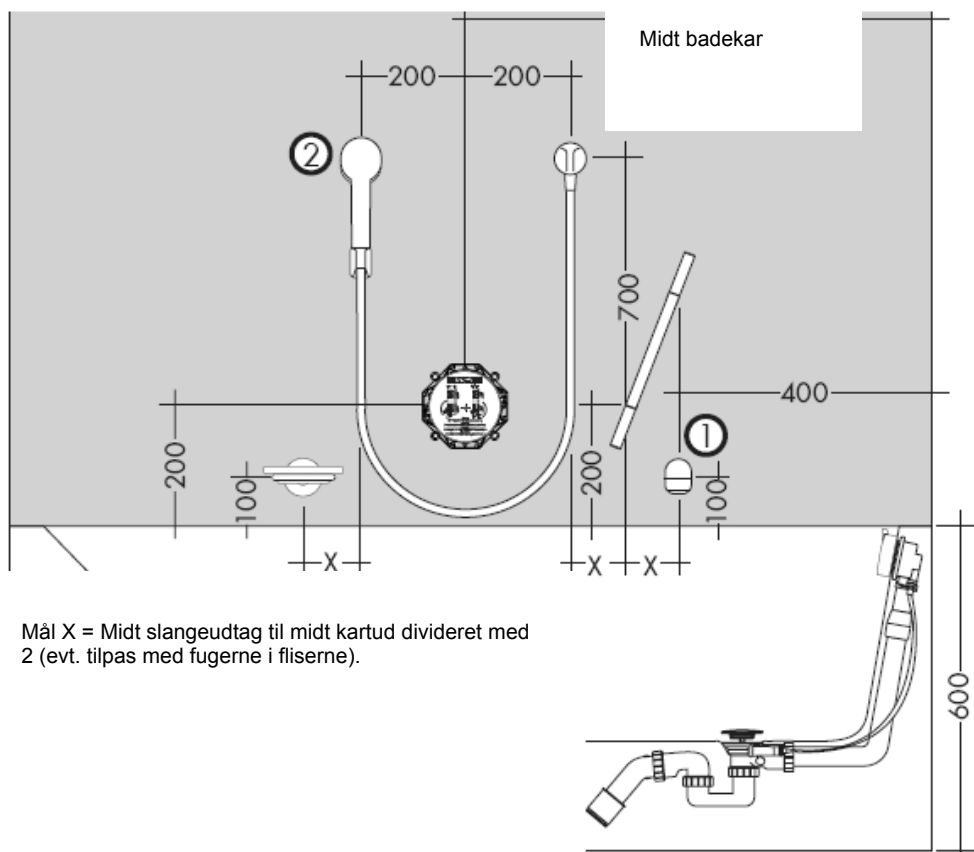

Mål X = Midt slangeudtag til midt kartud divideret med 2 (evt. tilpas med fugerne i fliserne).

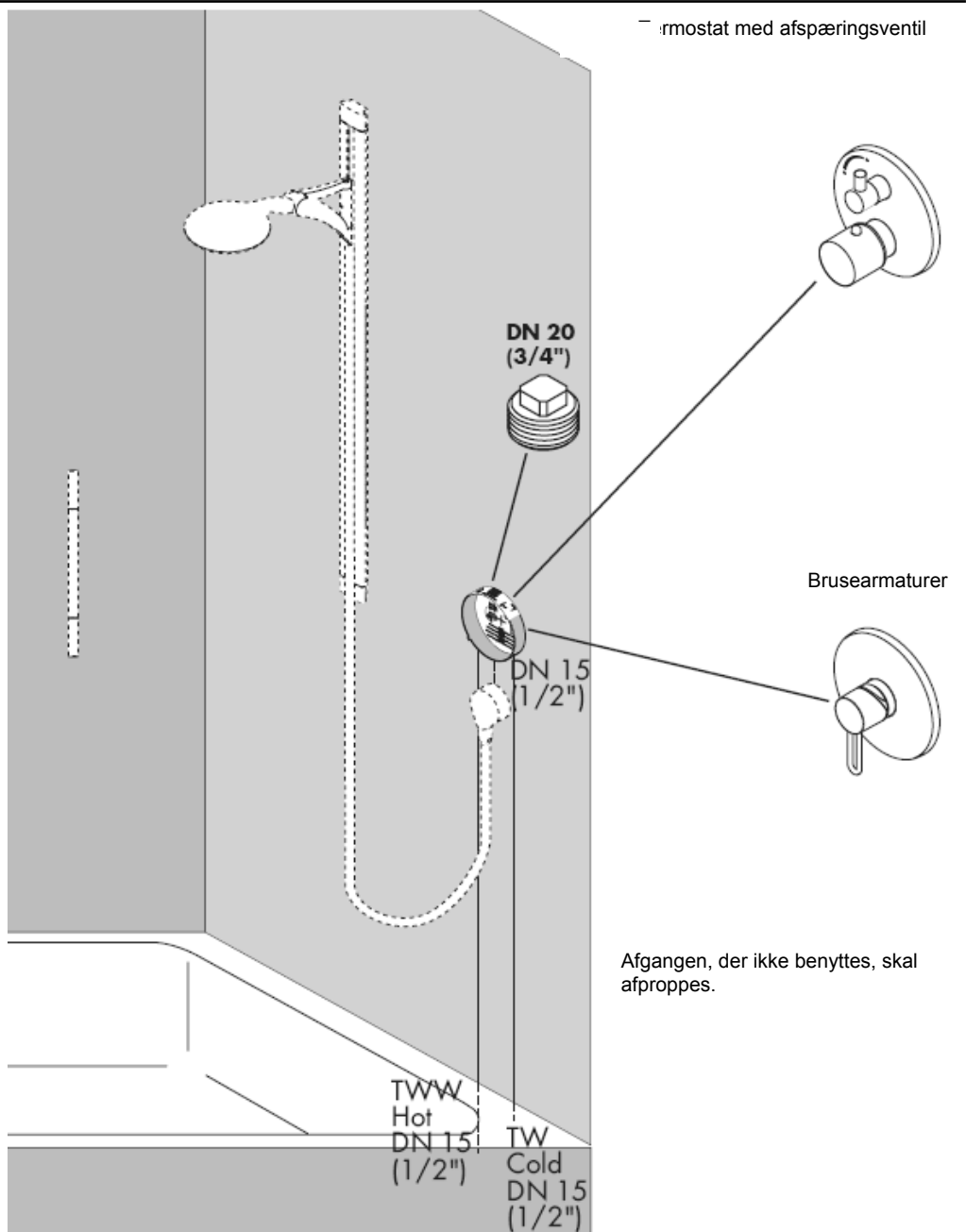

— rmostat med afspæringsventil

DN 20
(3/4")

DN 15
(1/2")

Brusearmaturer

Afgangen, der ikke benyttes, skal afproppes.

TWW
Hot
DN 15
(1/2")

TW
Cold
DN 15
(1/2")

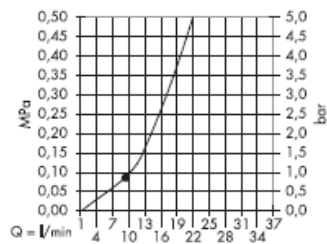
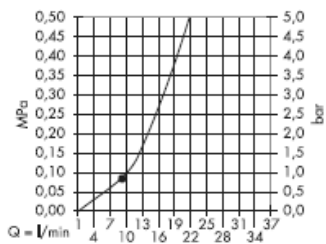

Fra • er funktionen anvendelig.

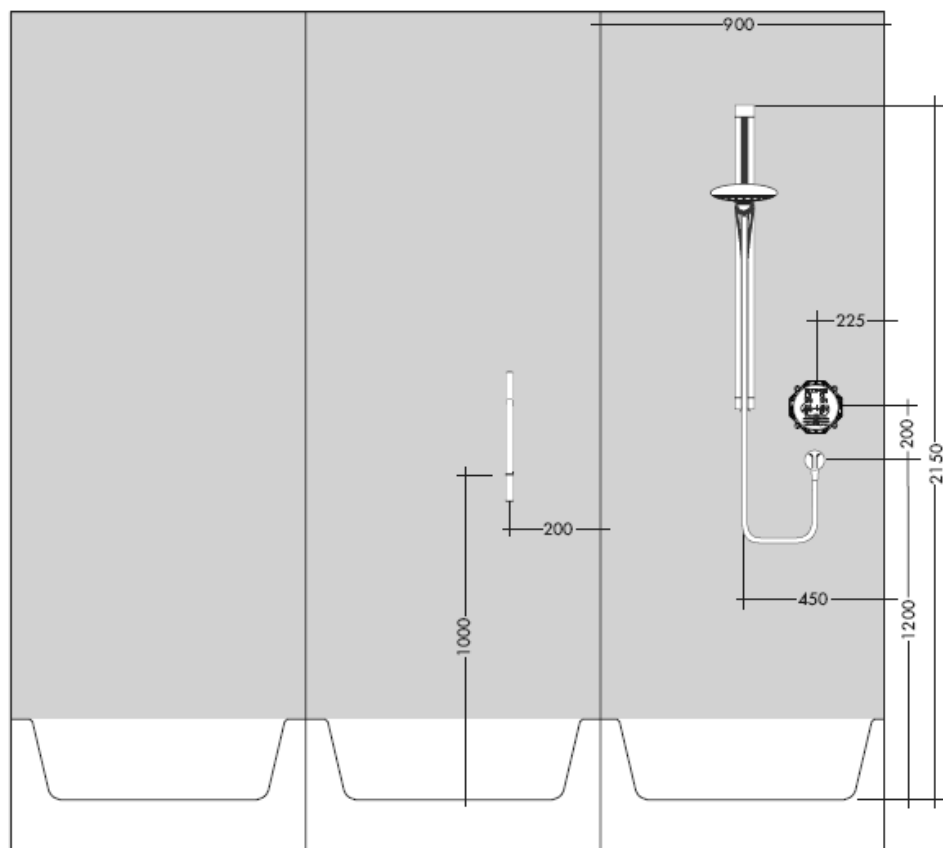

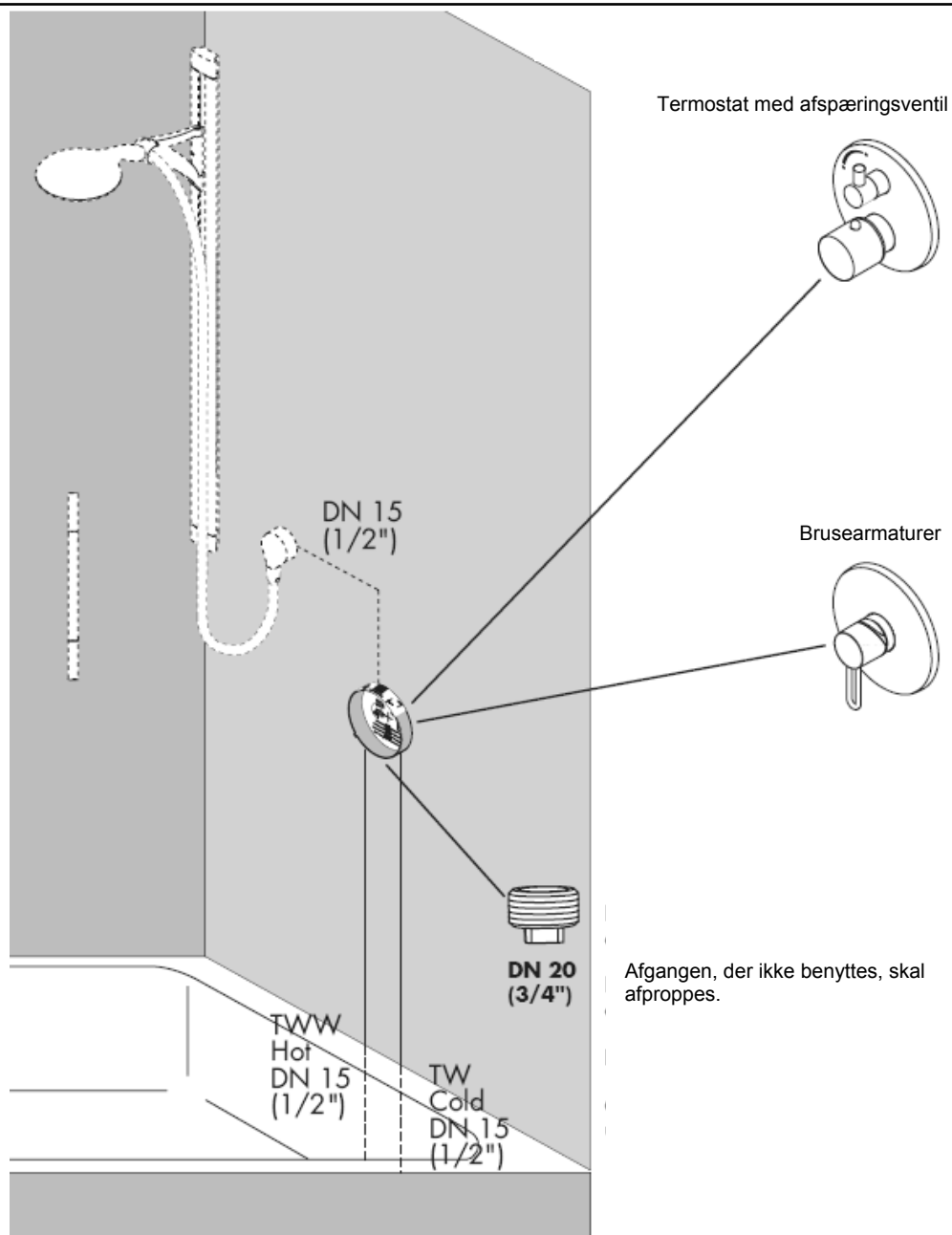

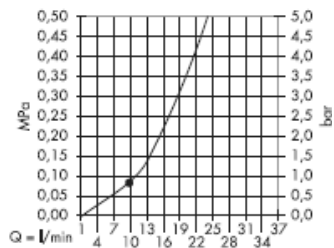
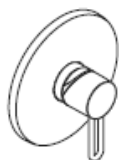
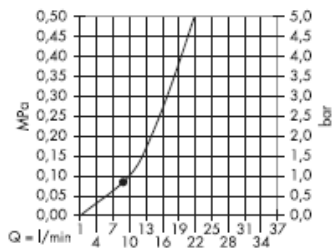

Fra • er funktionen anvendelig.

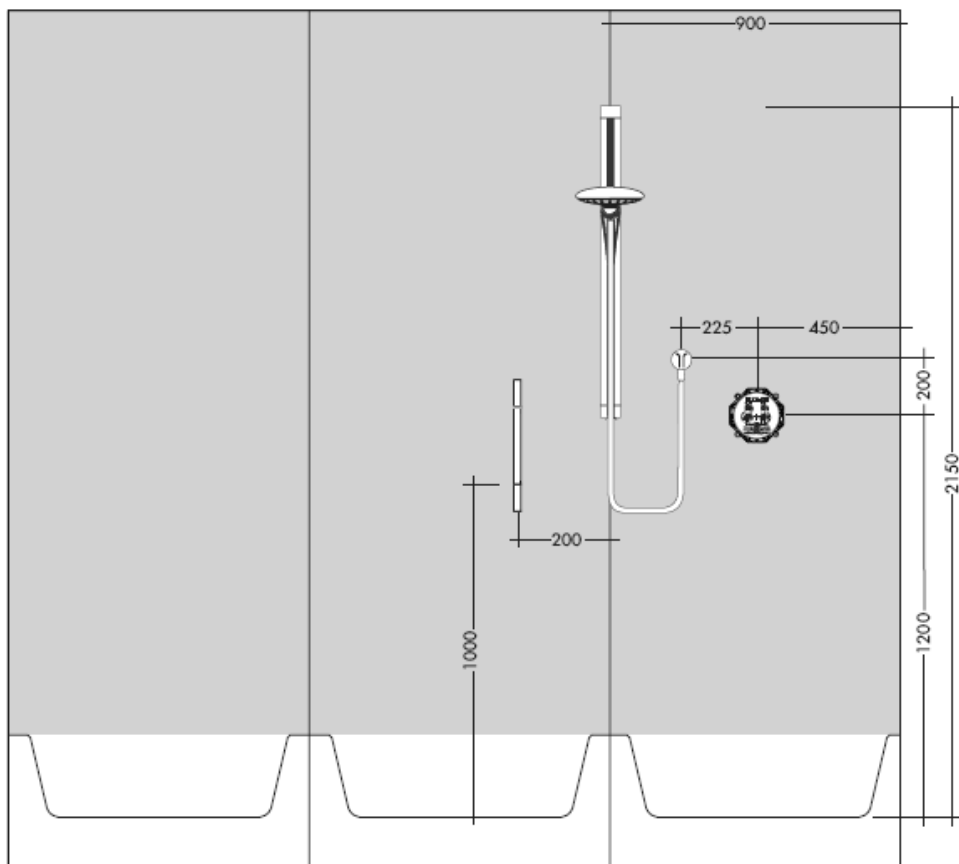

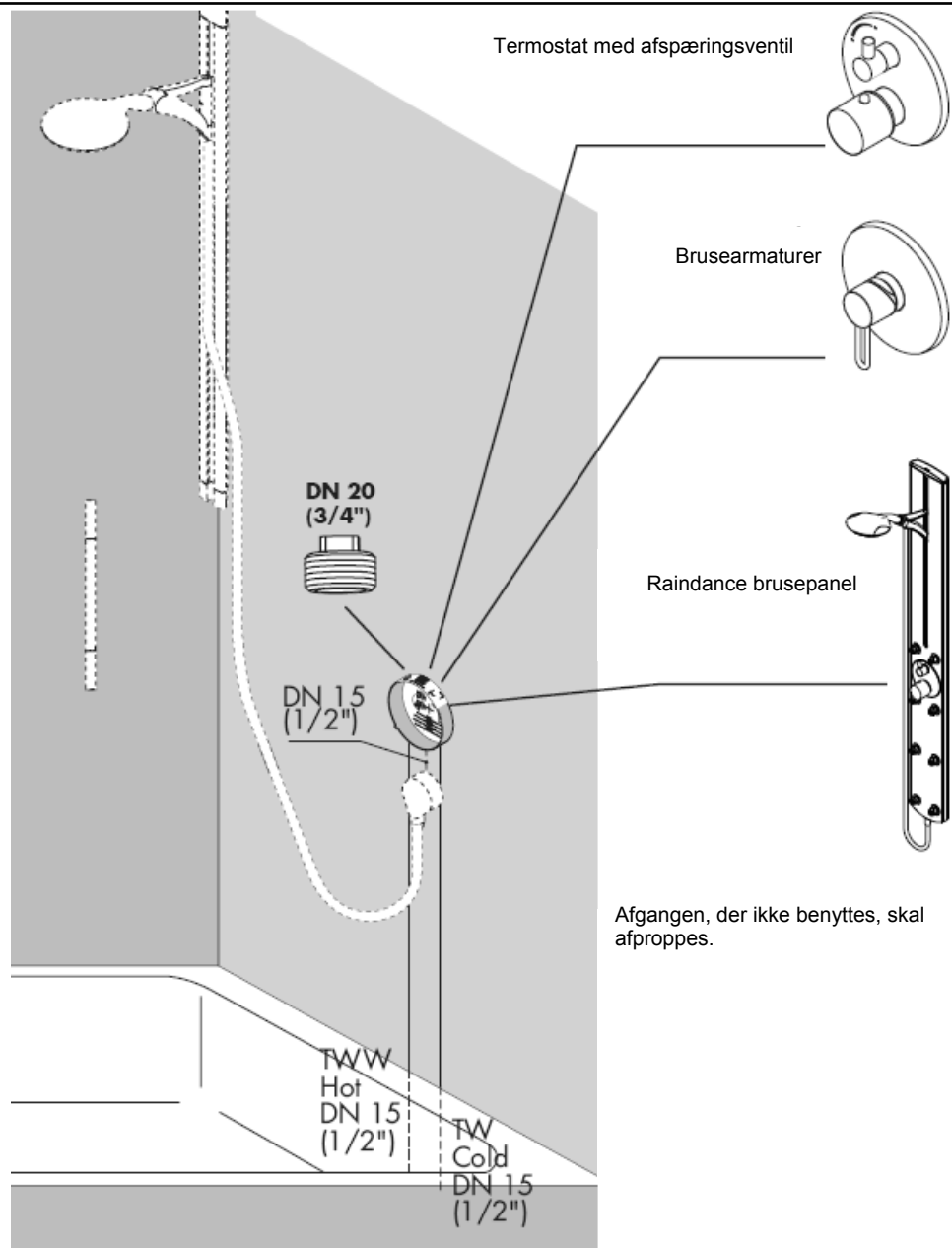

Brusetermostat med elektronisk start-/stopknop.



Termostat med afspæringsventil



Brusearmaturer

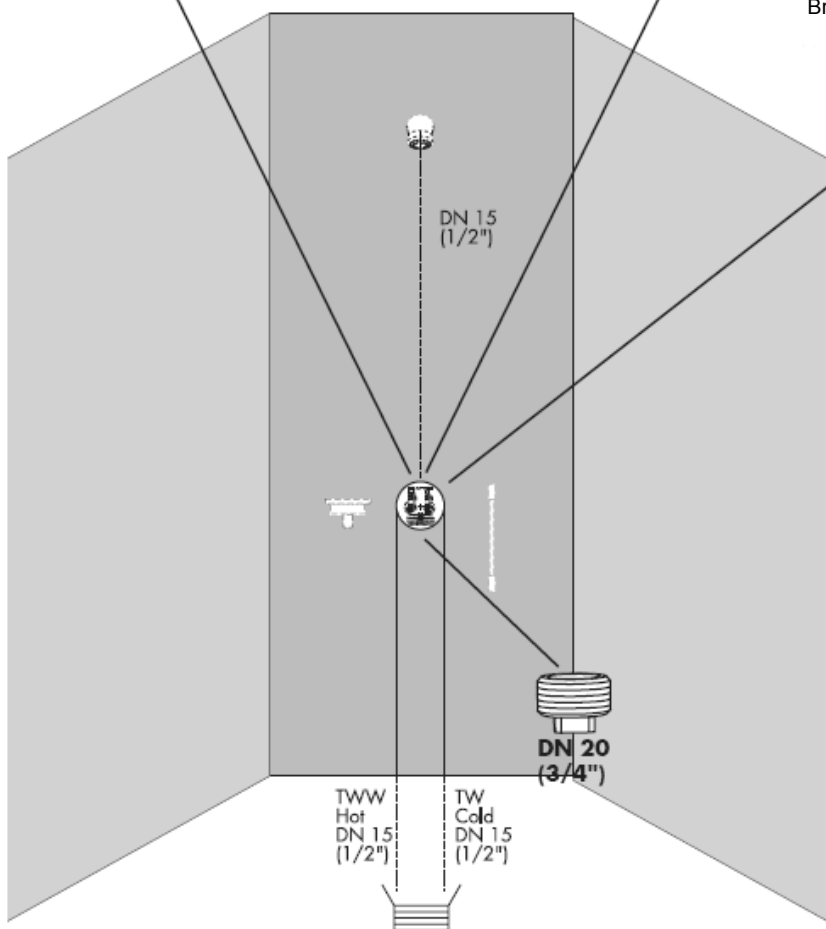
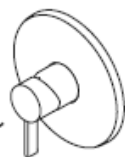

Afgangen, der ikke benyttes, skal afropes.

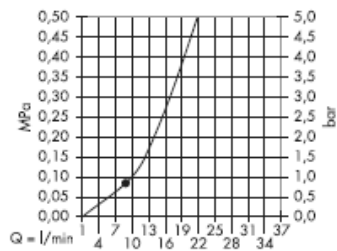
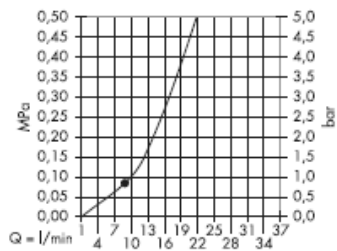

Fra • er funktionen anvendelig.

X = Midt brusekar

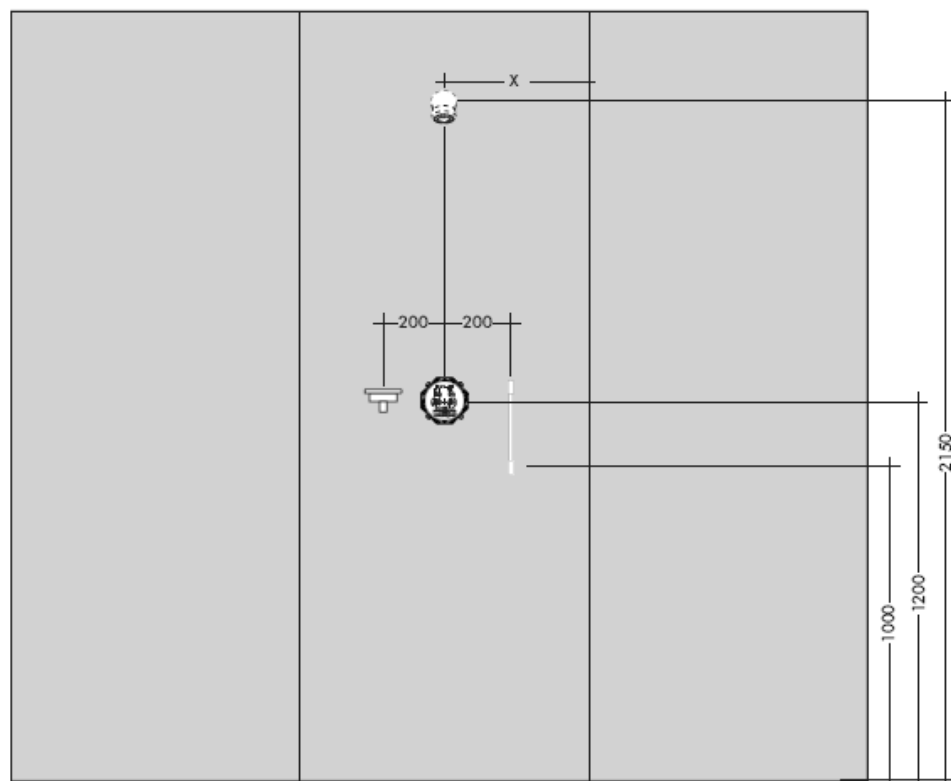

Termostat med afspæringsventil og omskifter

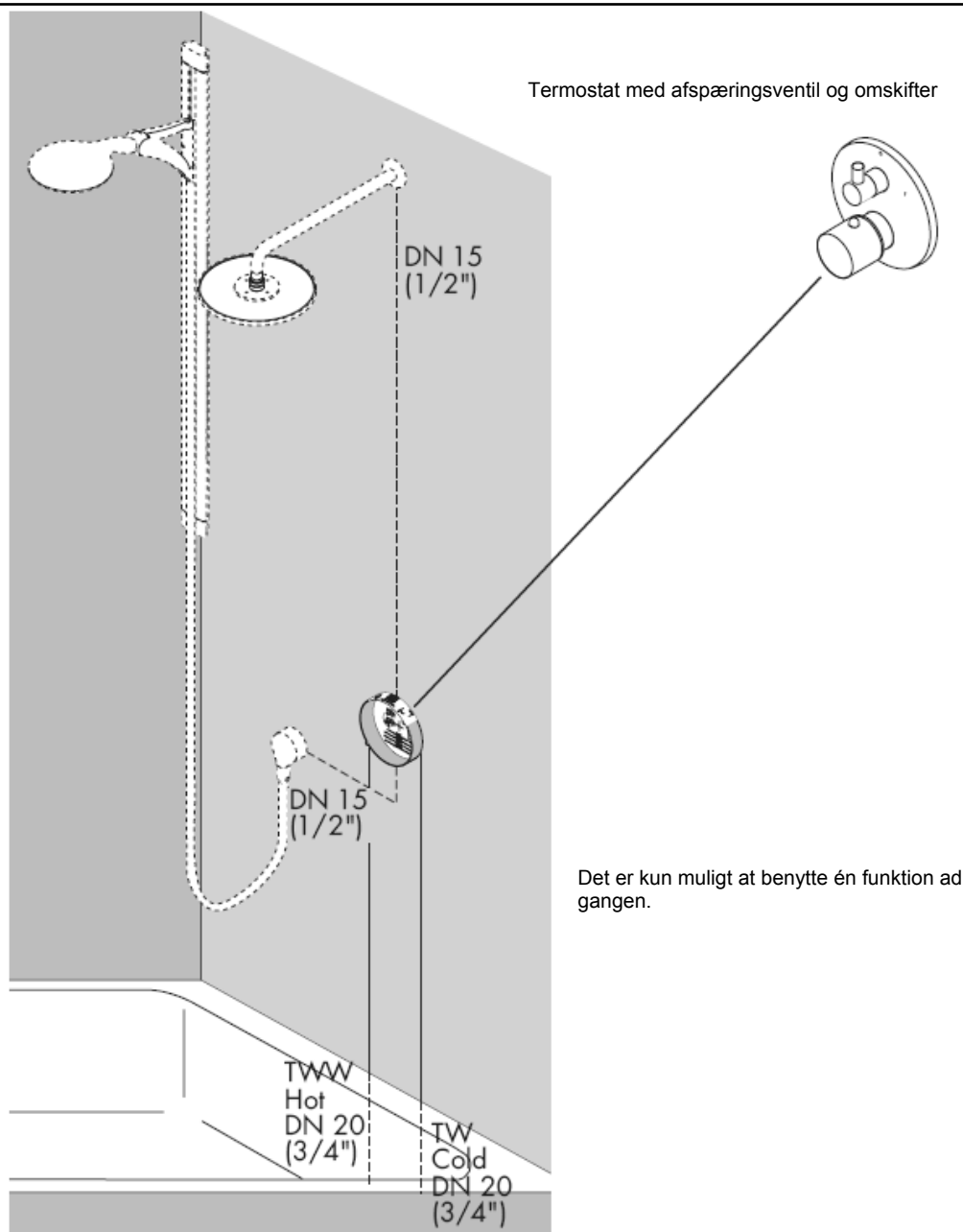

Det er kun muligt at benytte én funktion ad gangen.

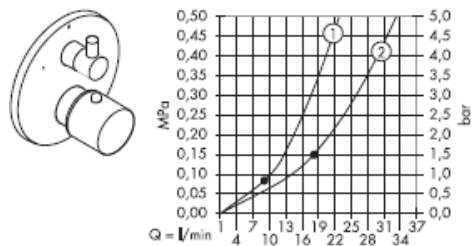

Fra • er funktionen anvendelig.

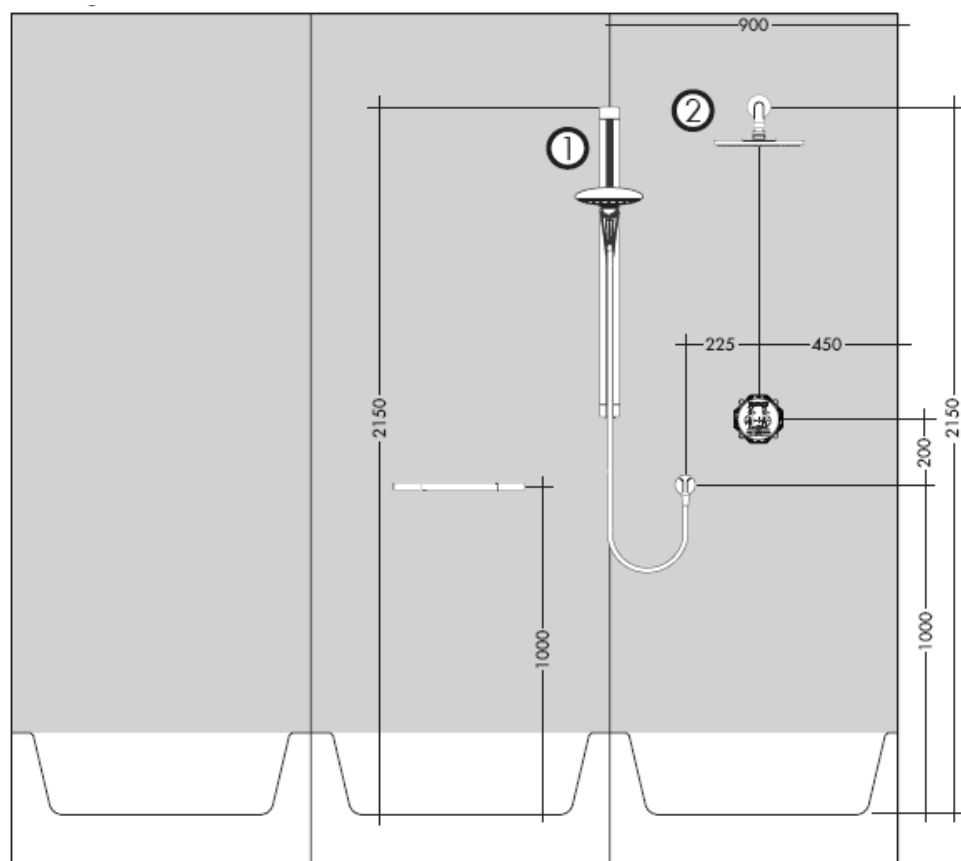

Termostat med afspæringsventil og omskifter

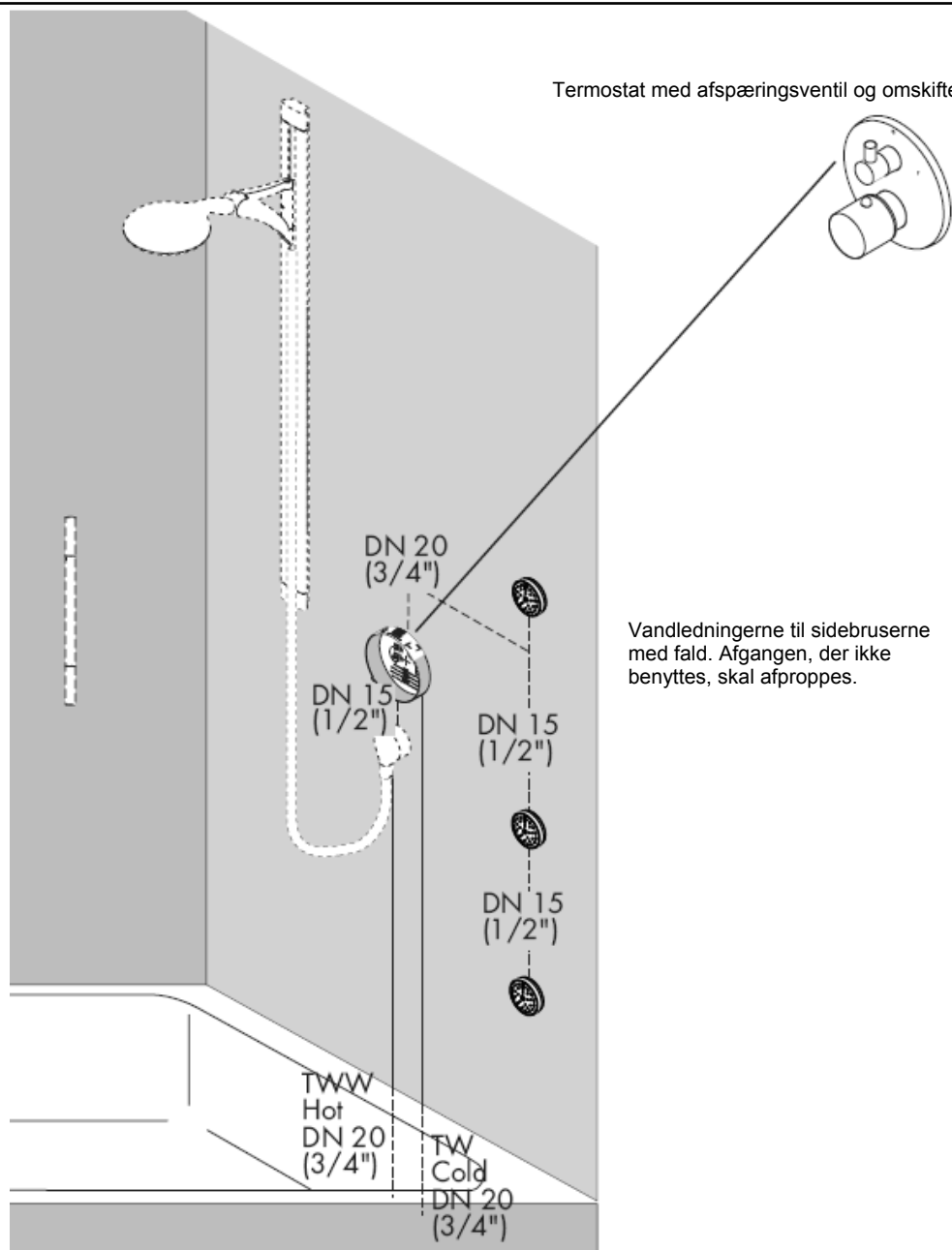

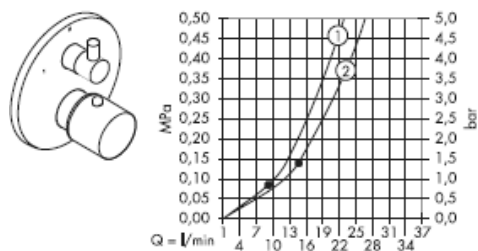

Fra • er funktionen anvendelig.

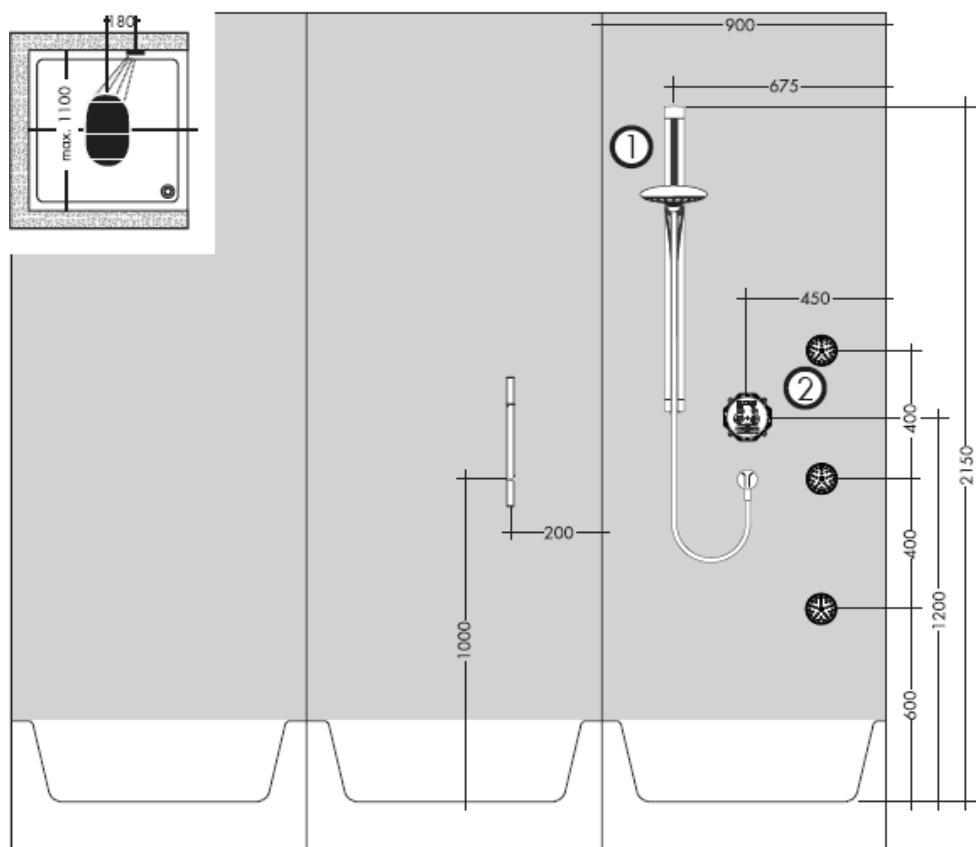

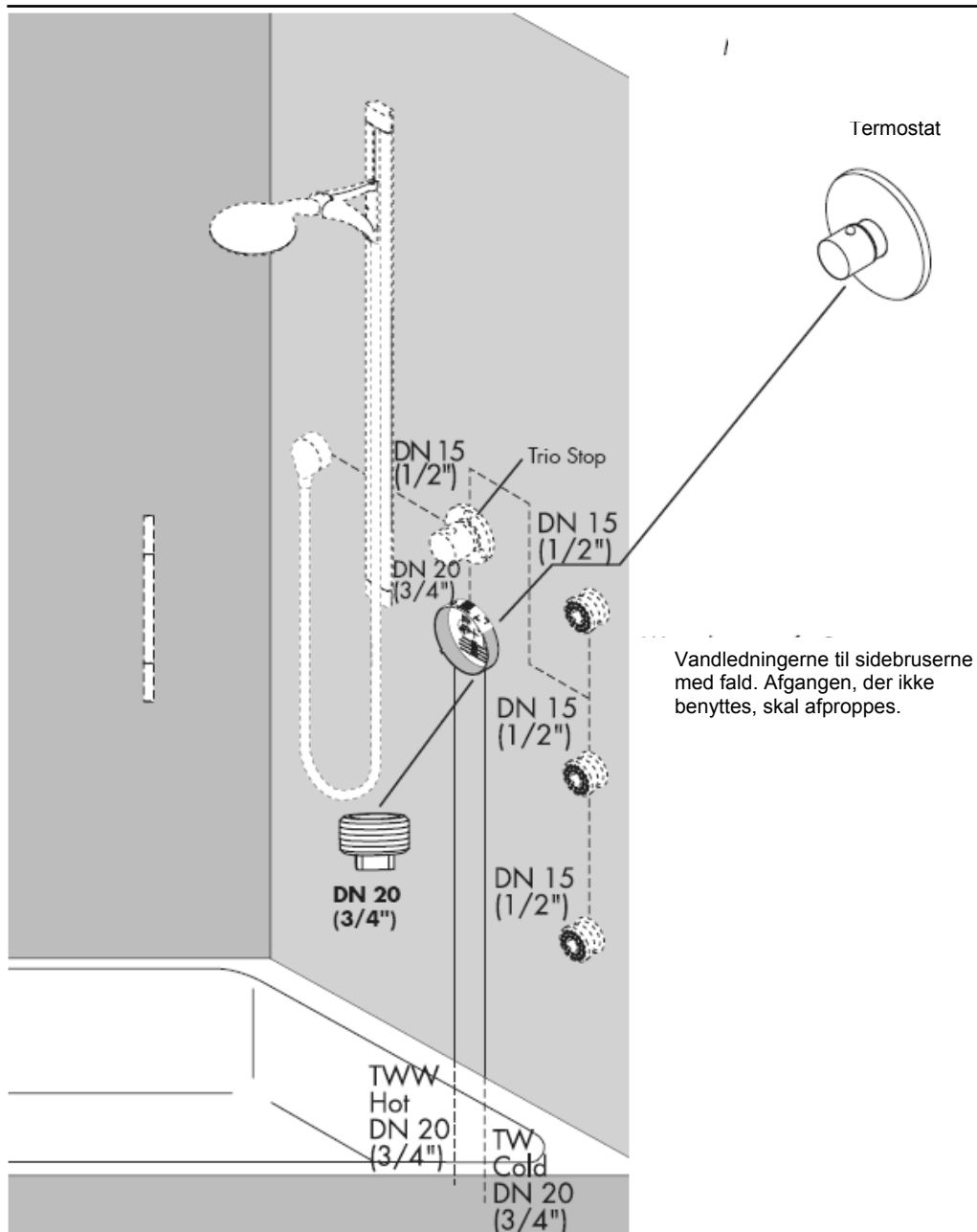

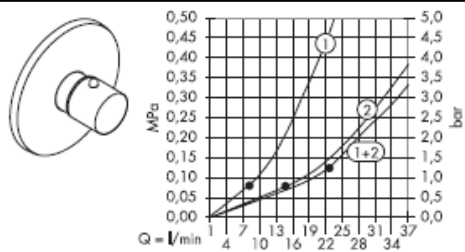

Fra • er funktionen anvendelig.

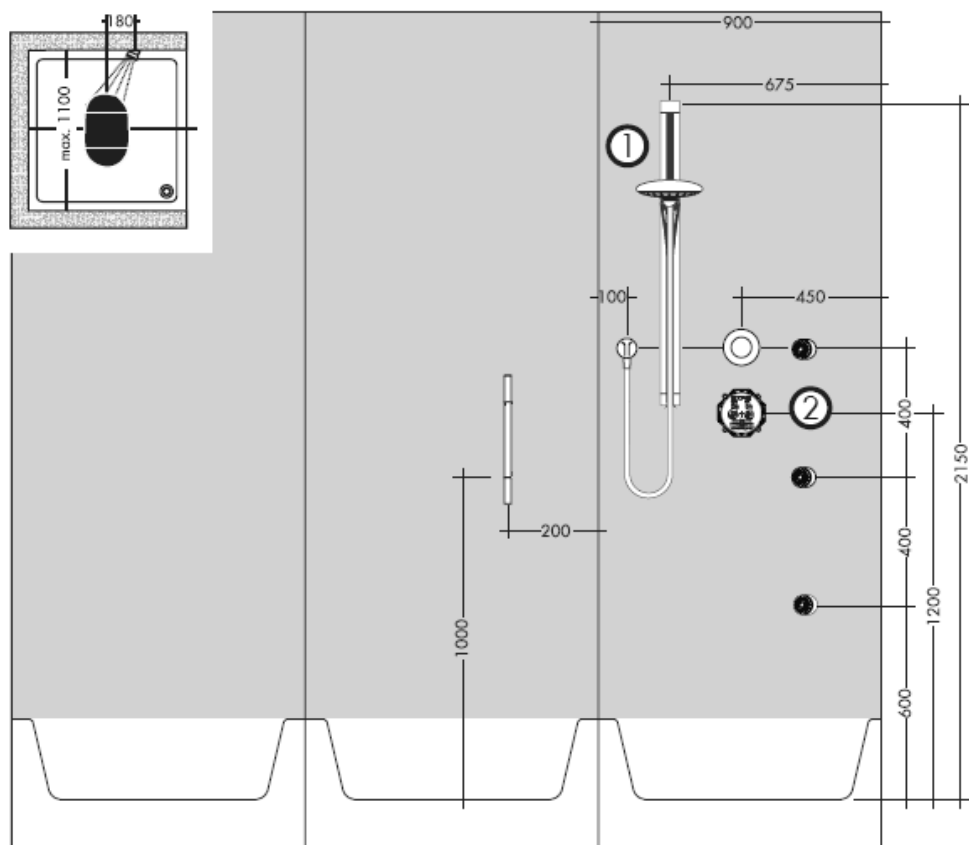

Thermostat
Mitigeur thermostatique
Thermostatic mixer
Termostatico

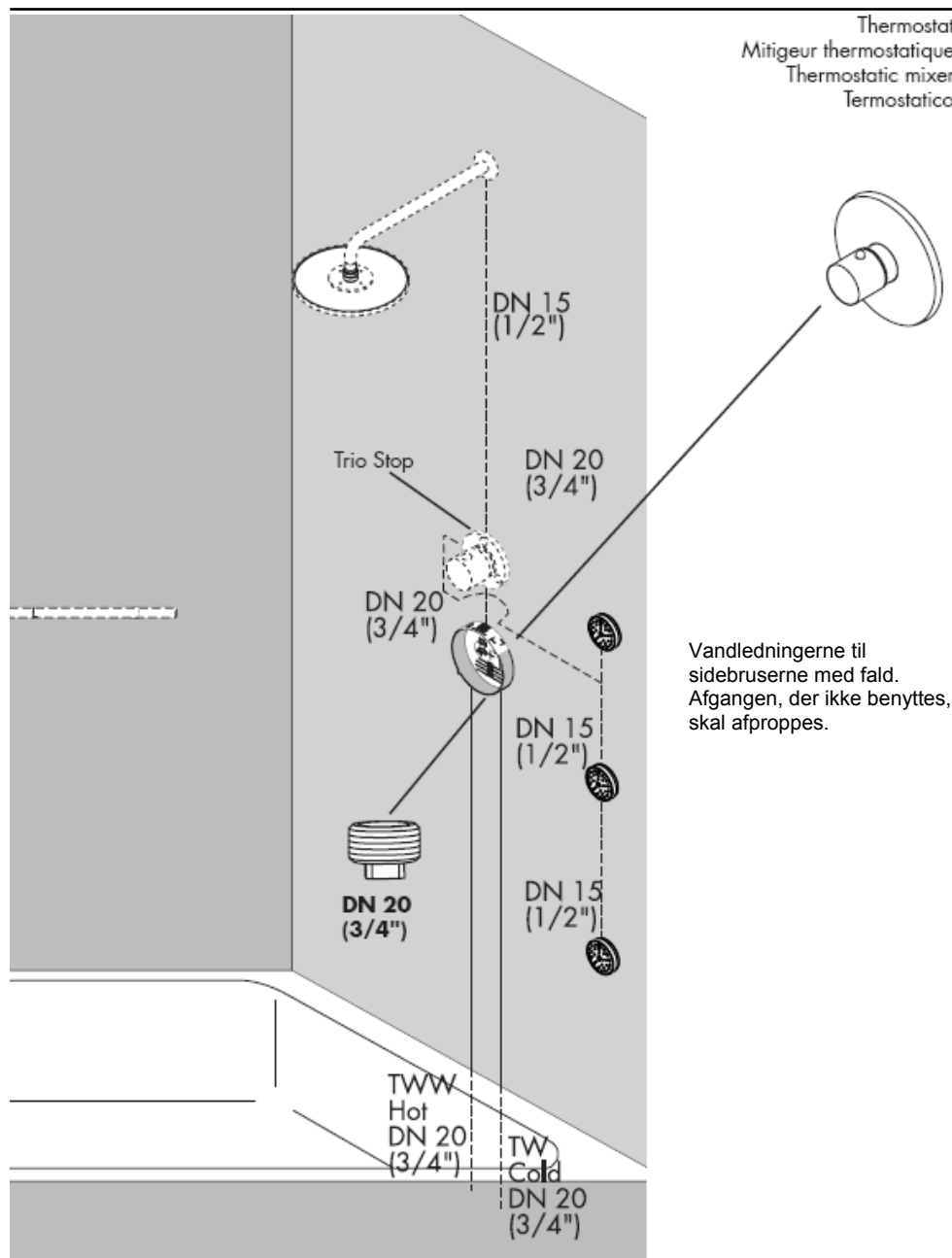

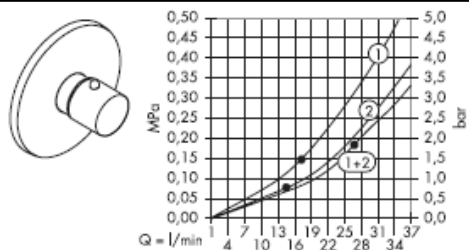

Ab ● ist die Funktion gewährleistet.
 A partir de ● le fonctionnement est garanti.
 From ● the function is guaranteed.
 Dal ● si garantisce la funzionalità.

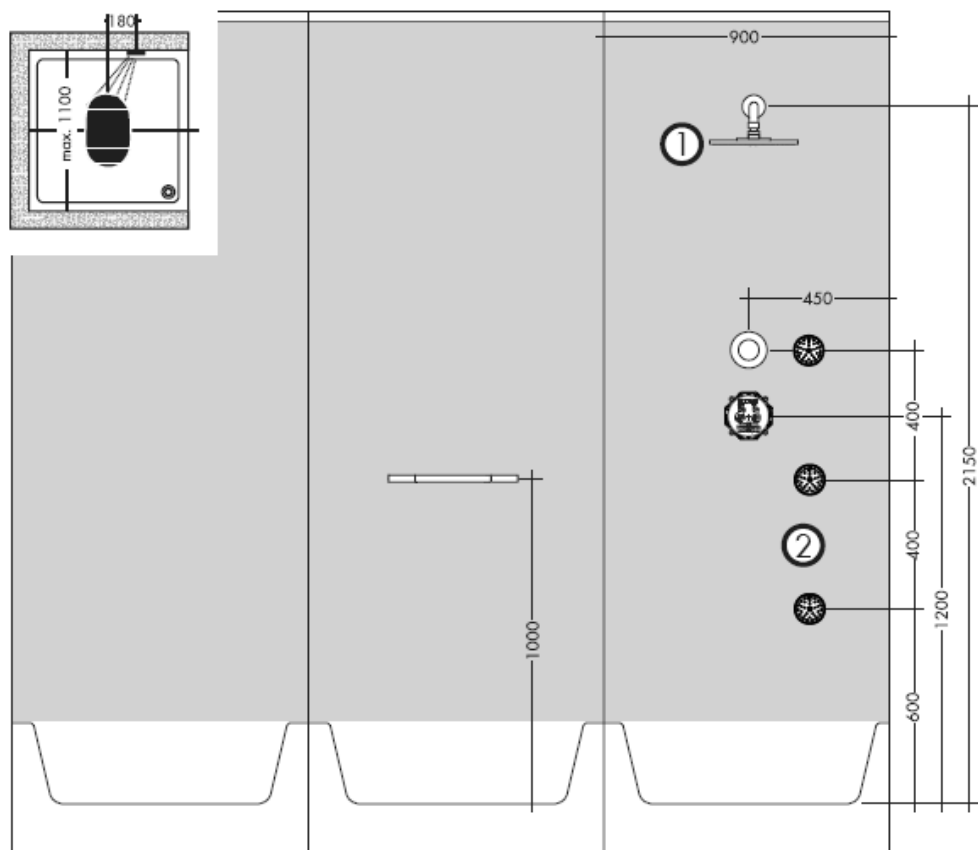
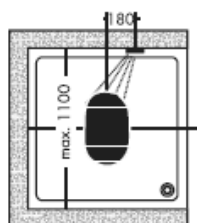

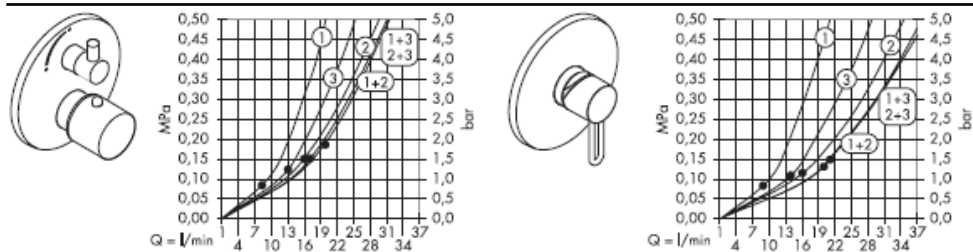

Fra • er funktionen anvendelig.

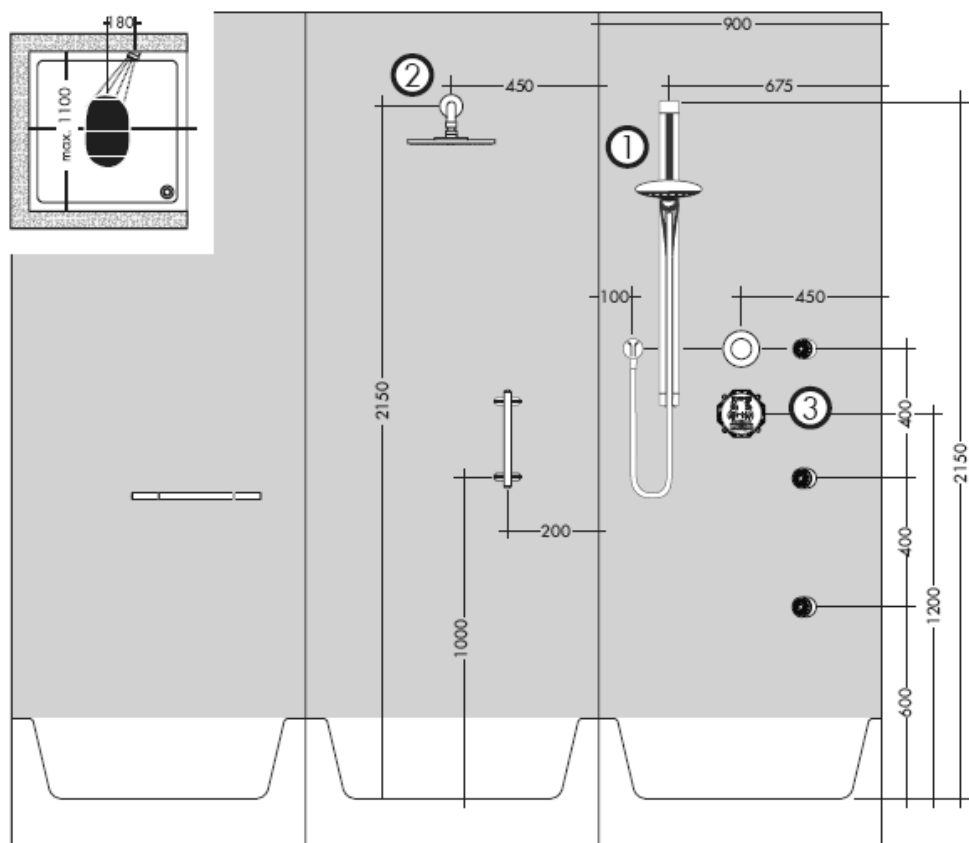

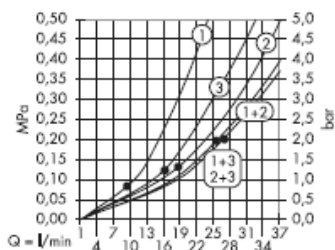

Uno/Uno²/Carlton/
Terrano/Montreux/
Metropol E + S/
Metris E + S/
Focus E + S/
Talis E²+S+S²+Classic

Massaud/
Citterio/
Citterio M/
Starck X

Starck/Steel

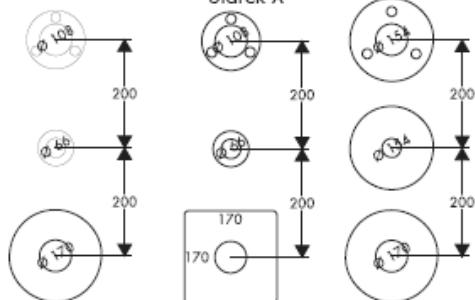

Fra • er funktionen anvendelig.

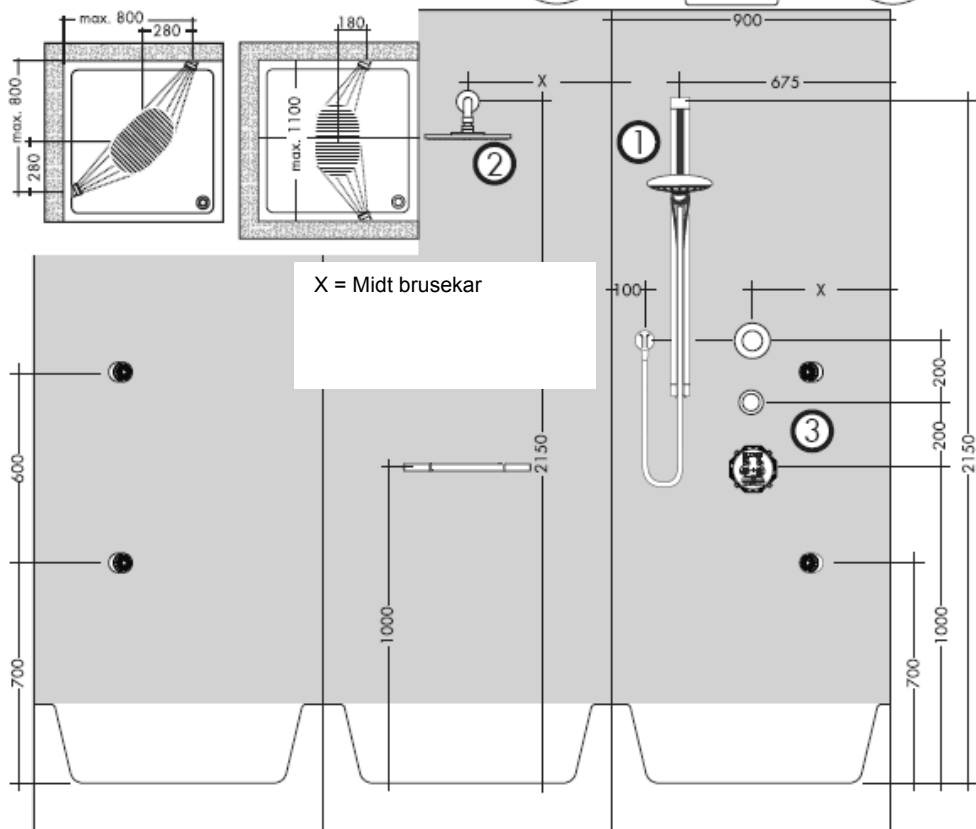

Termostat med afspæringsventil og omskifter

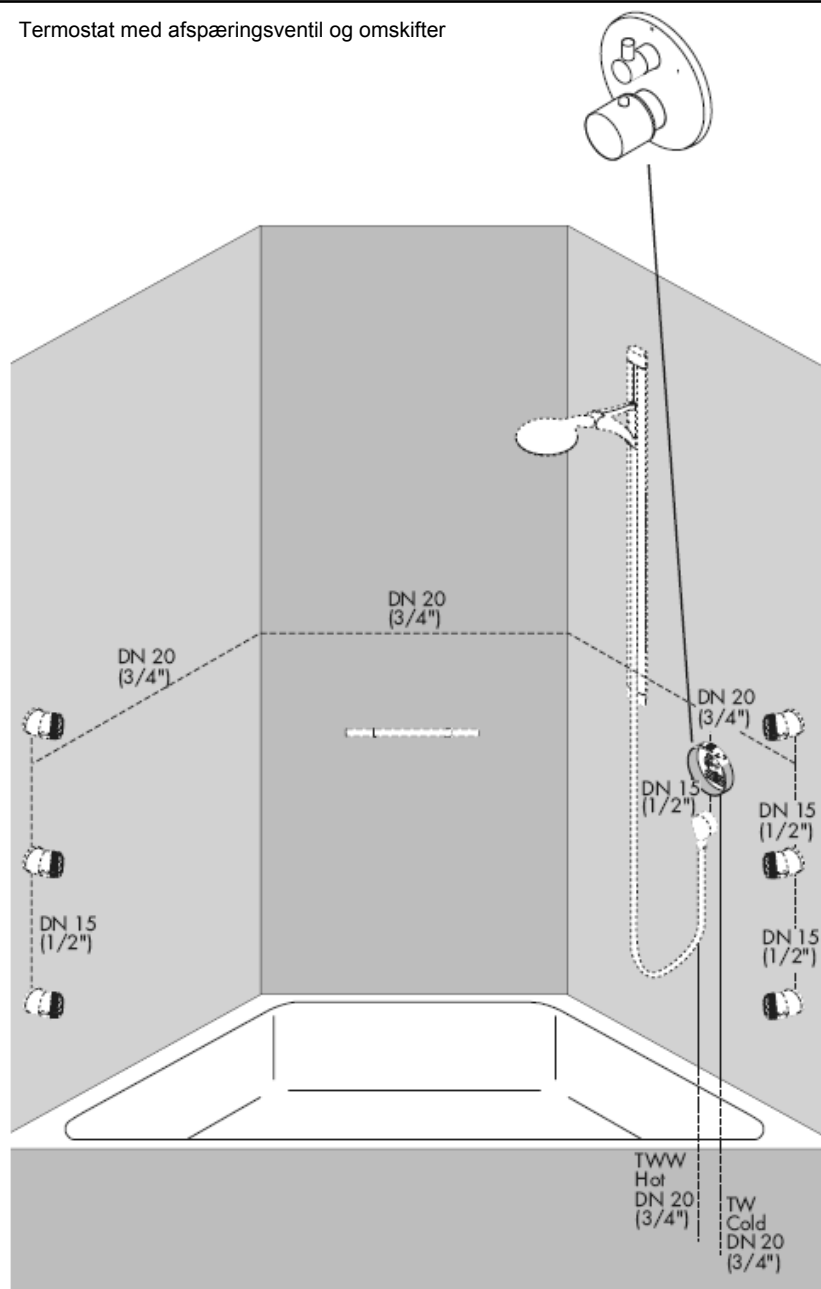

Vandledningerne til sidebruserne med fald. Afgangen, der ikke benyttes, skal afproppes.

Termostat

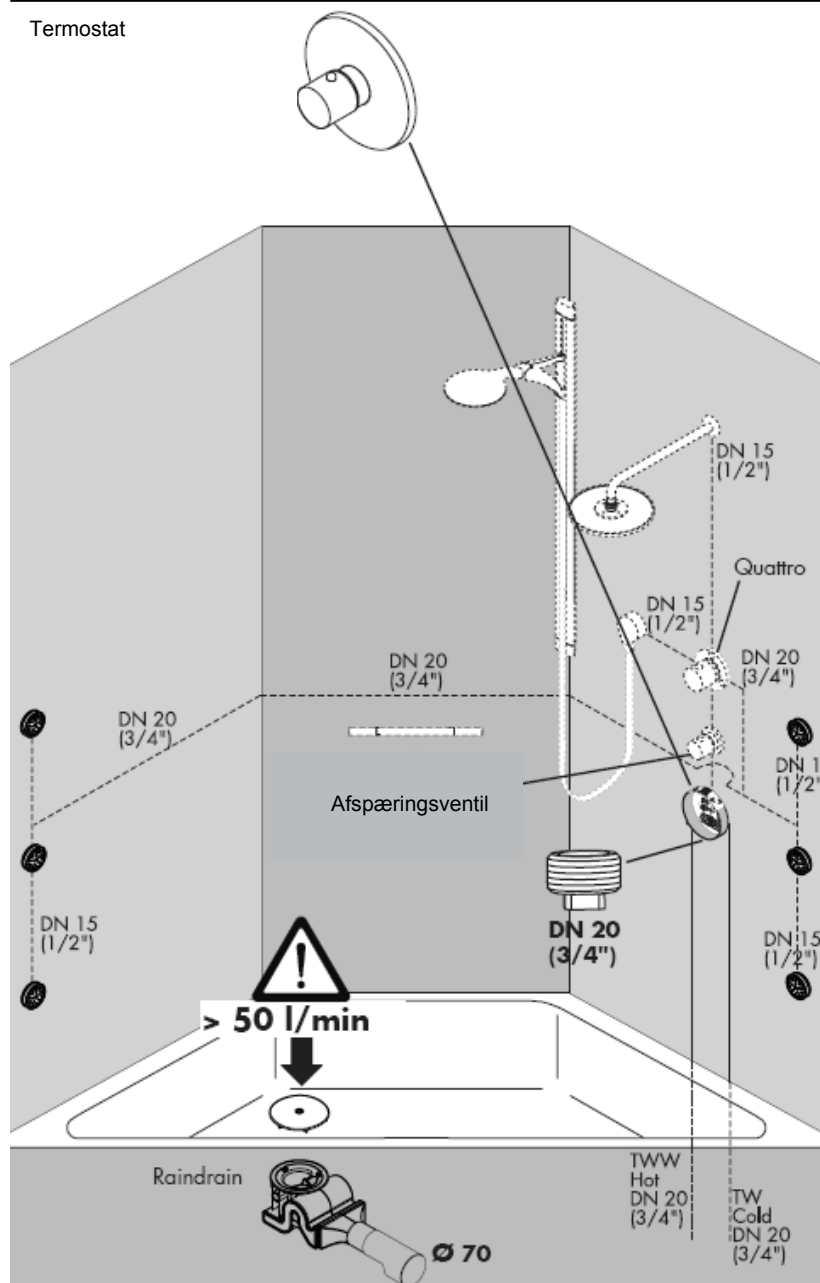

Vandledningerne til sidebruserne med fald. Afgangen, der ikke benyttes, skal afropres.

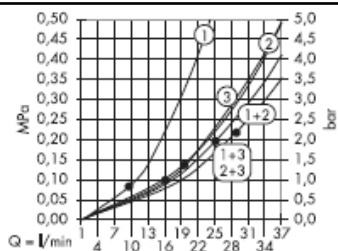

Uno/Uno²/Carlton/
Terrano/Montreux/
Metropol E + S/
Metris E + S/
Focus E + S/
Talis E²+S+S²+Classic

Massaud/
Citterio/
Citterio M/
Starck X

Starck/Steel

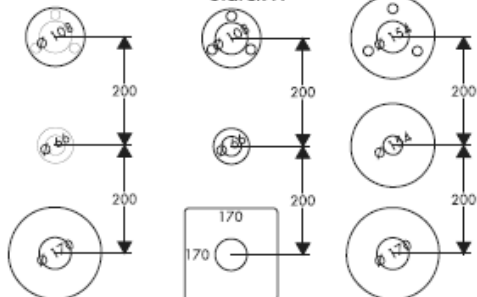

Fra • er funktionen anvendelig.

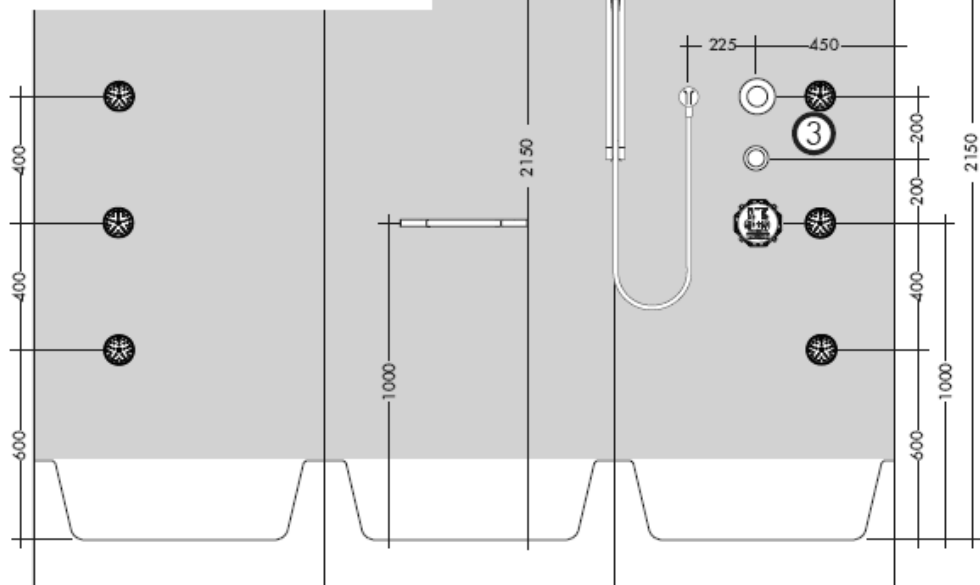
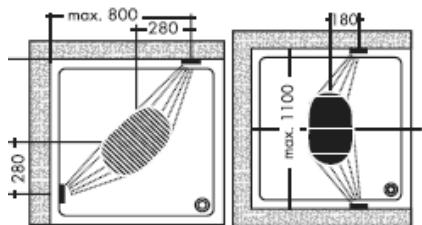

Termostat

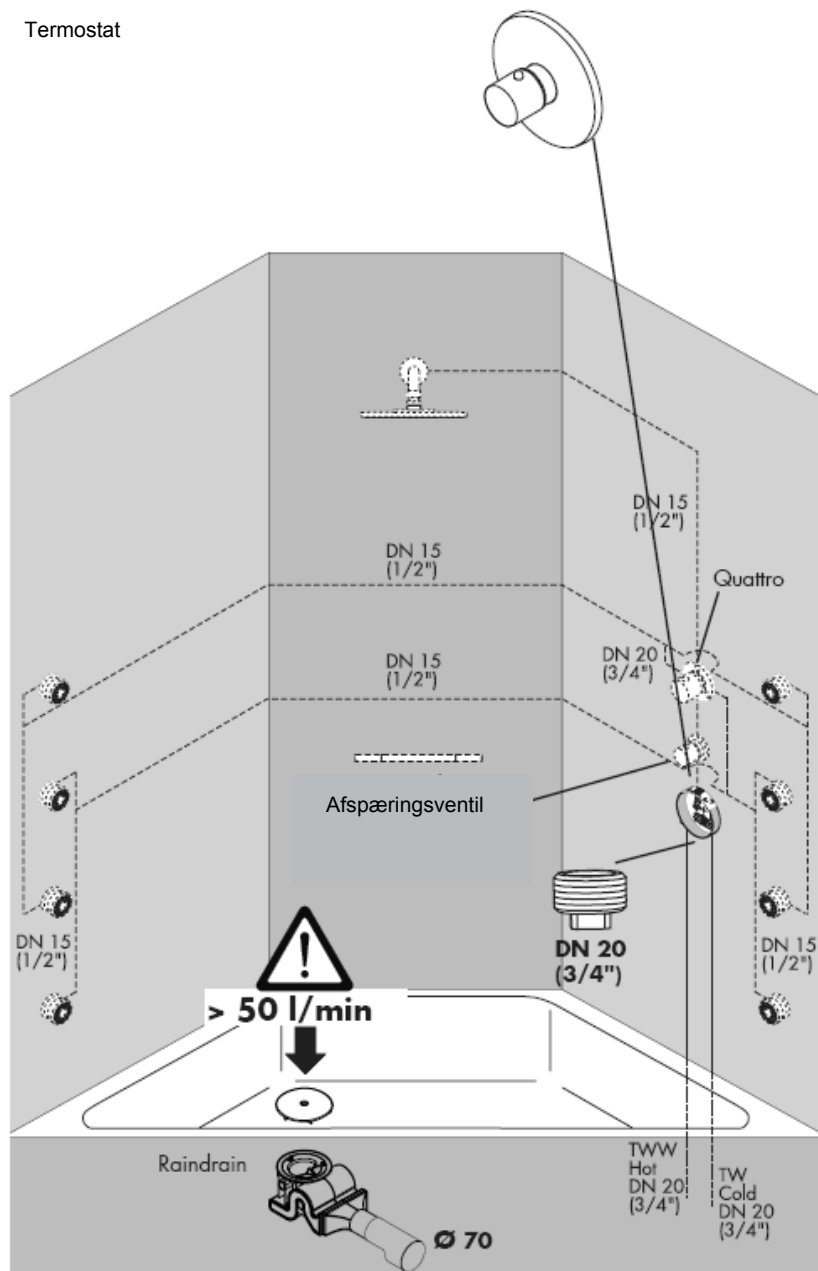

Vandledningerne til sidebruserne med fald. Afgangen, der ikke benyttes, skal afproppes.

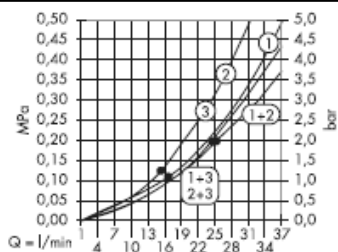

Uno/Uno²/Carlton/
Terrano/Montreux/
Metropol E + S/
Metris E + S/
Focus E + S/
Talis E²+S+S²+Classic

Massaud/
Citterio/
Citterio M/
Starck X

Starck/Steel

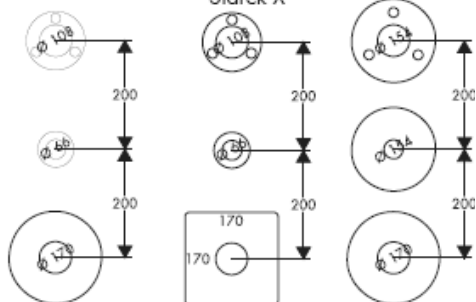

Fra • er funktionen anvendelig.

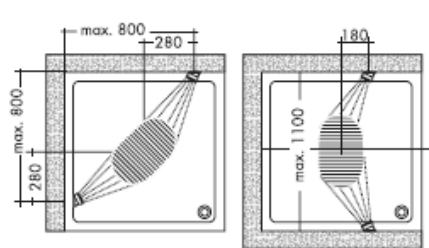

X = Midt brusekar

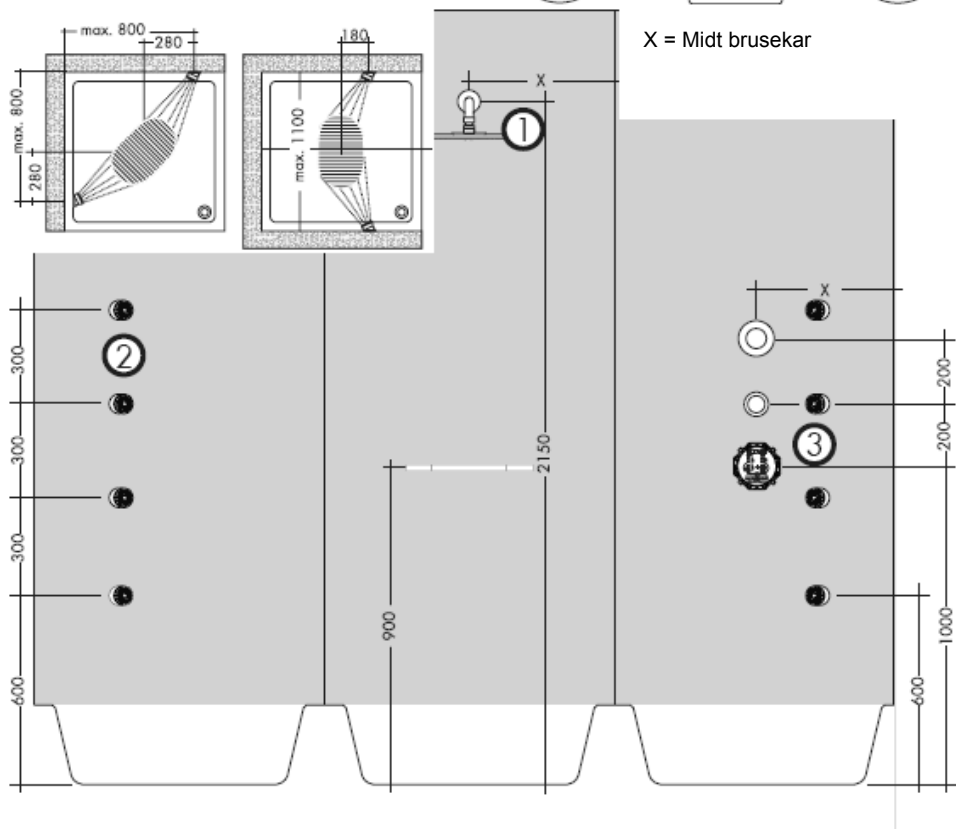

Raindance brusepanel

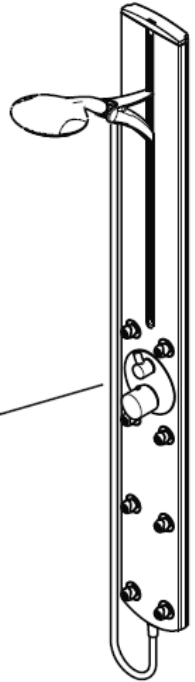
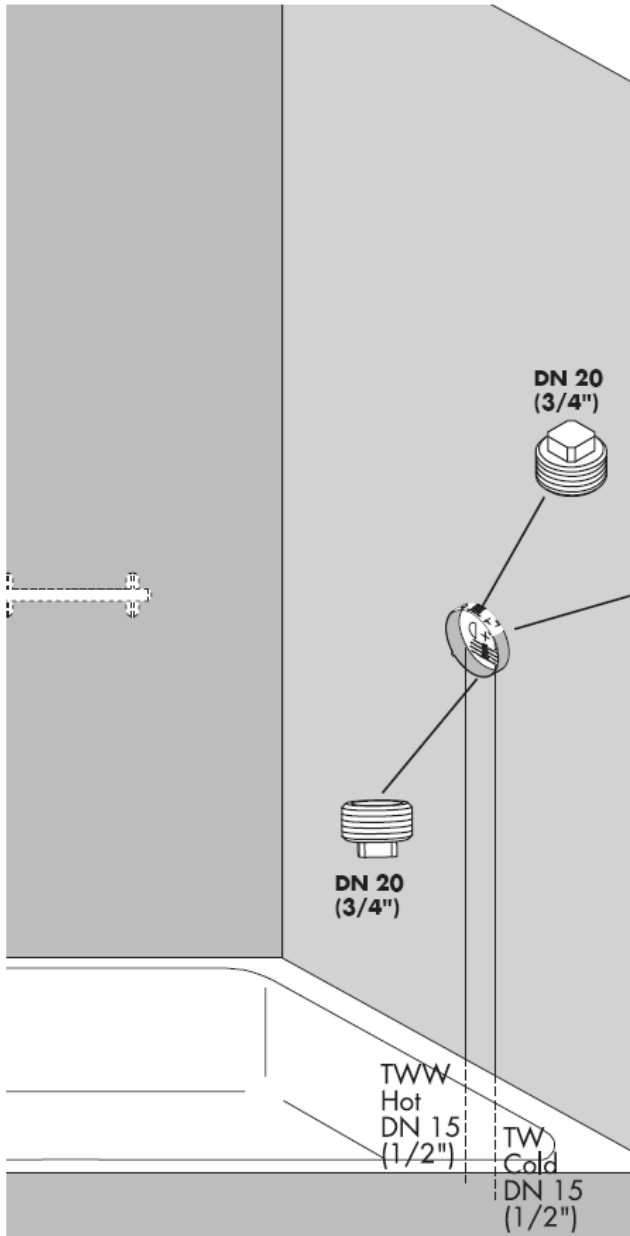

Afgangen, der ikke benyttes, skal afroppes.

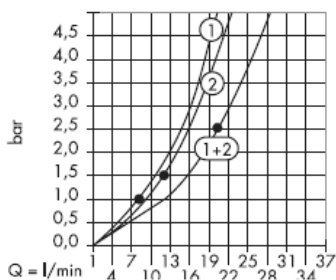

Fra • er funktionen anvendelig.

X = Midt brusekar

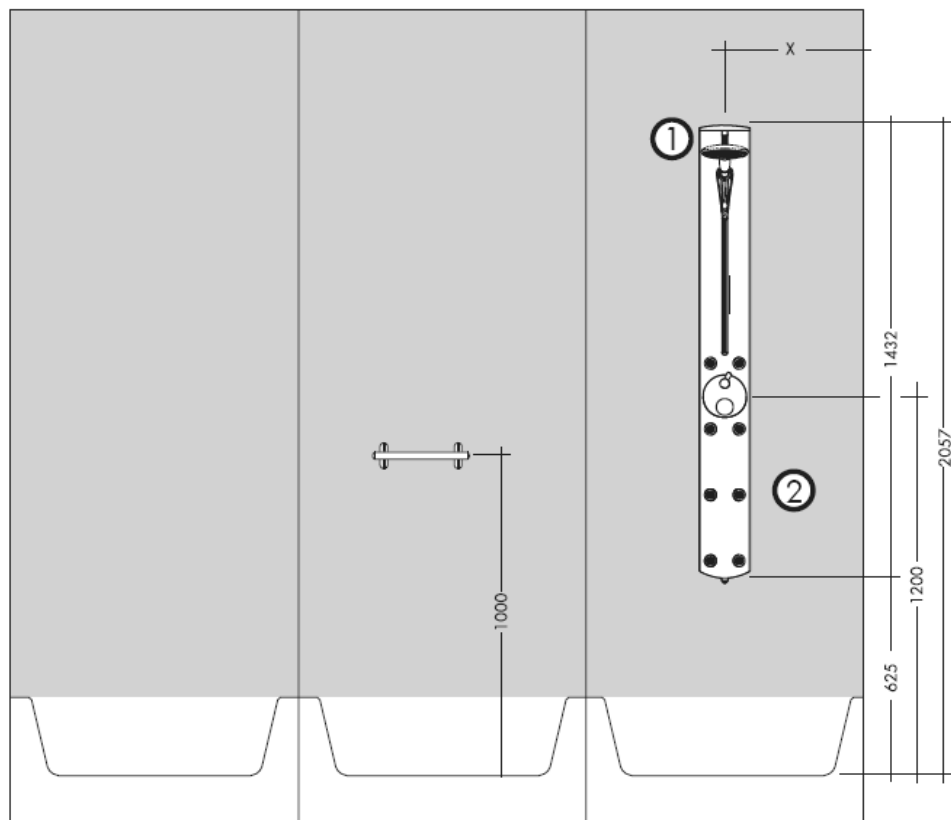

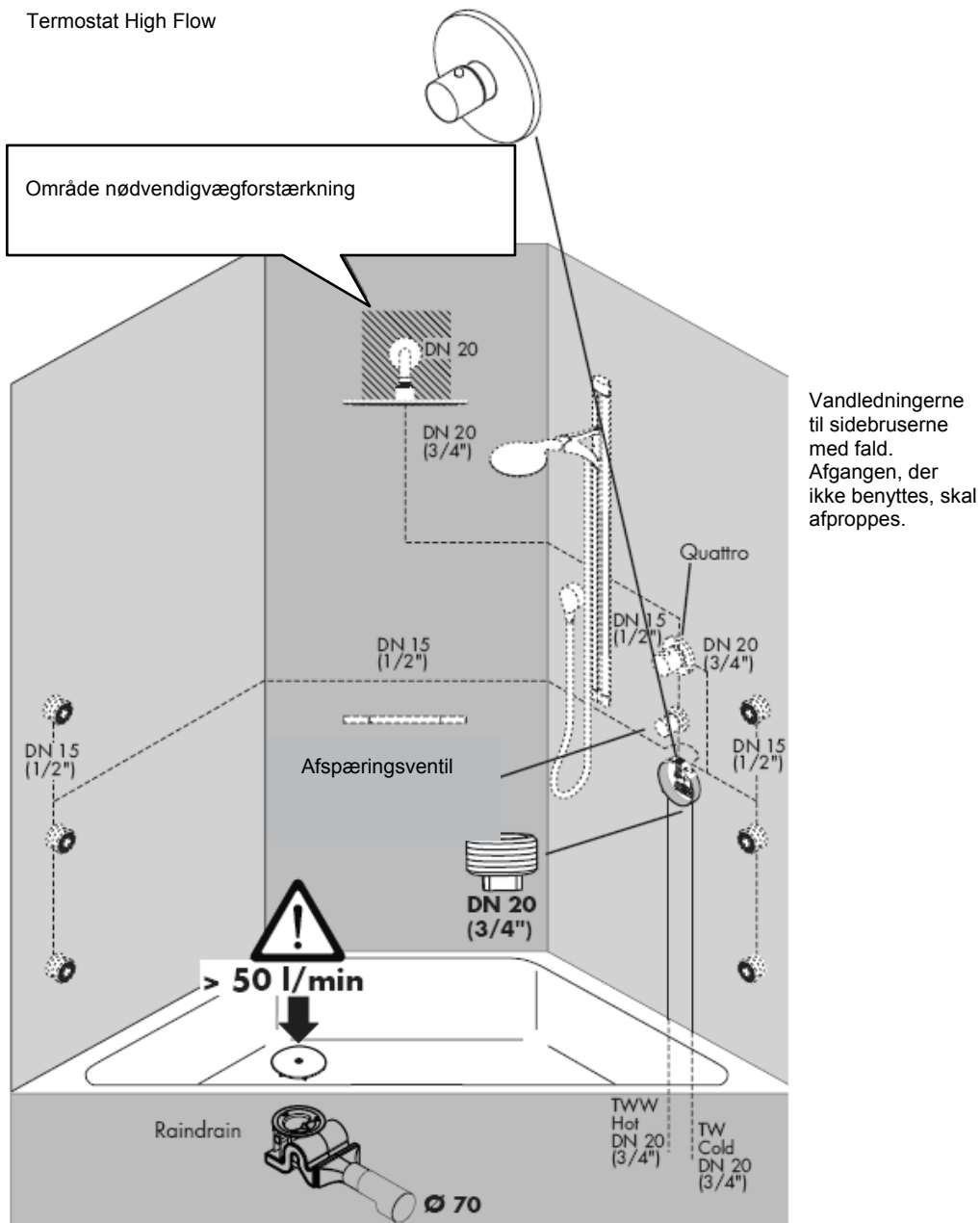

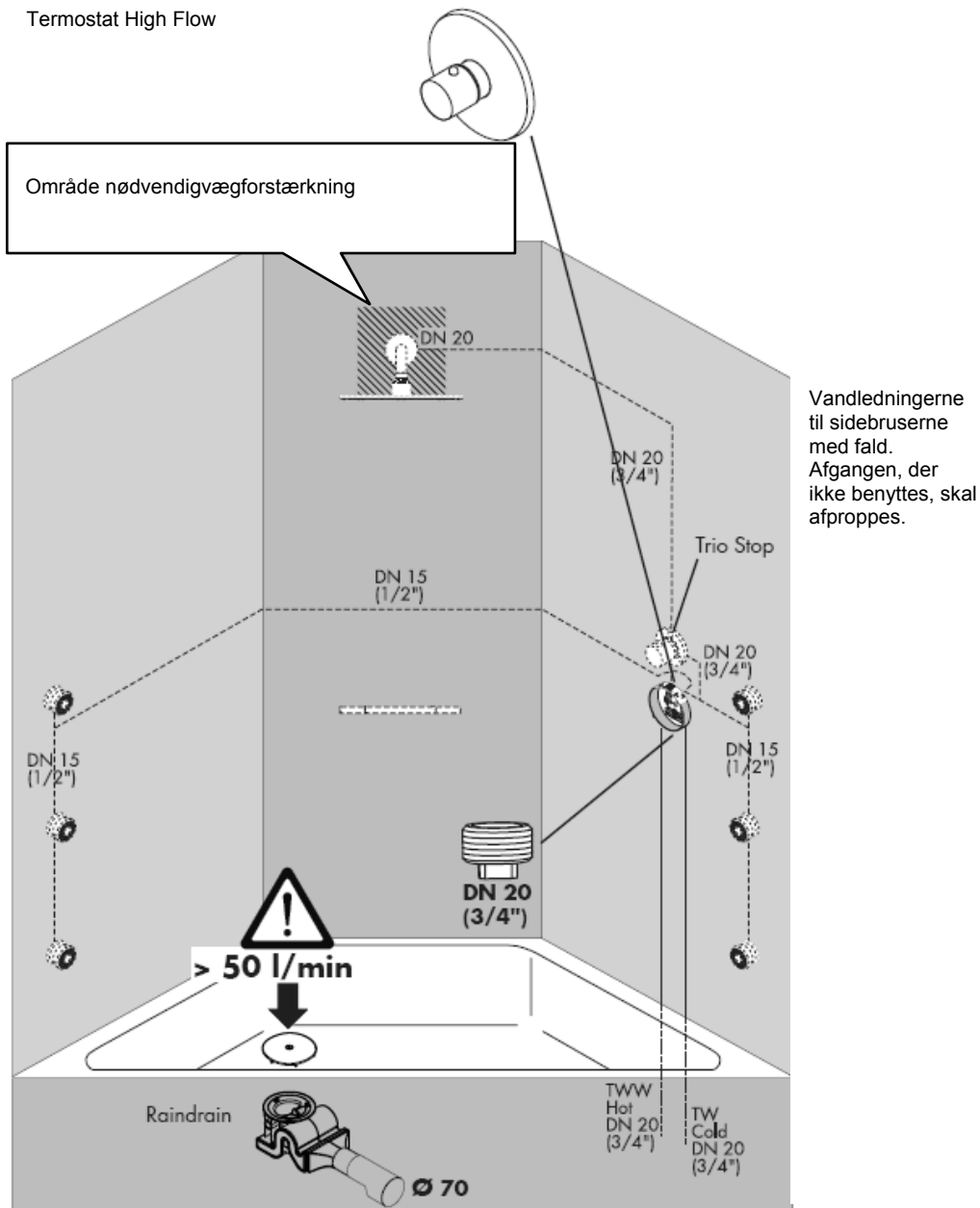

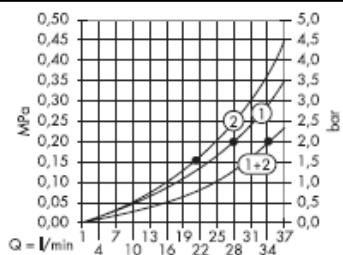

Fra • er funktionen anvendelig.

X = Midt brusekar

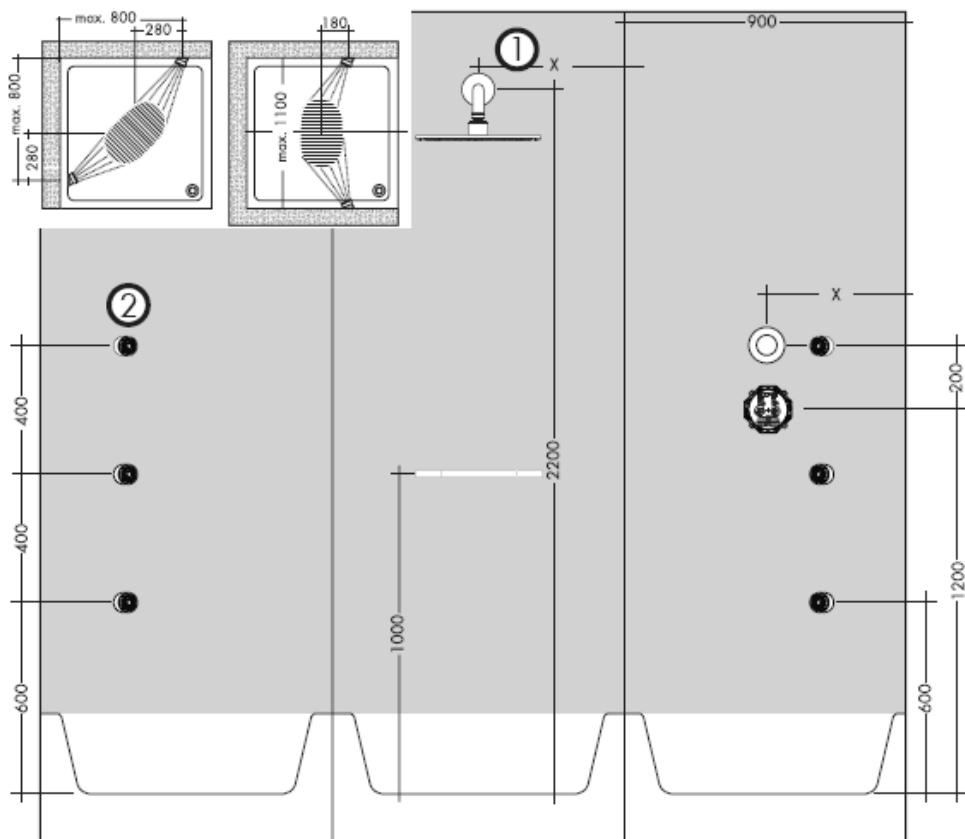

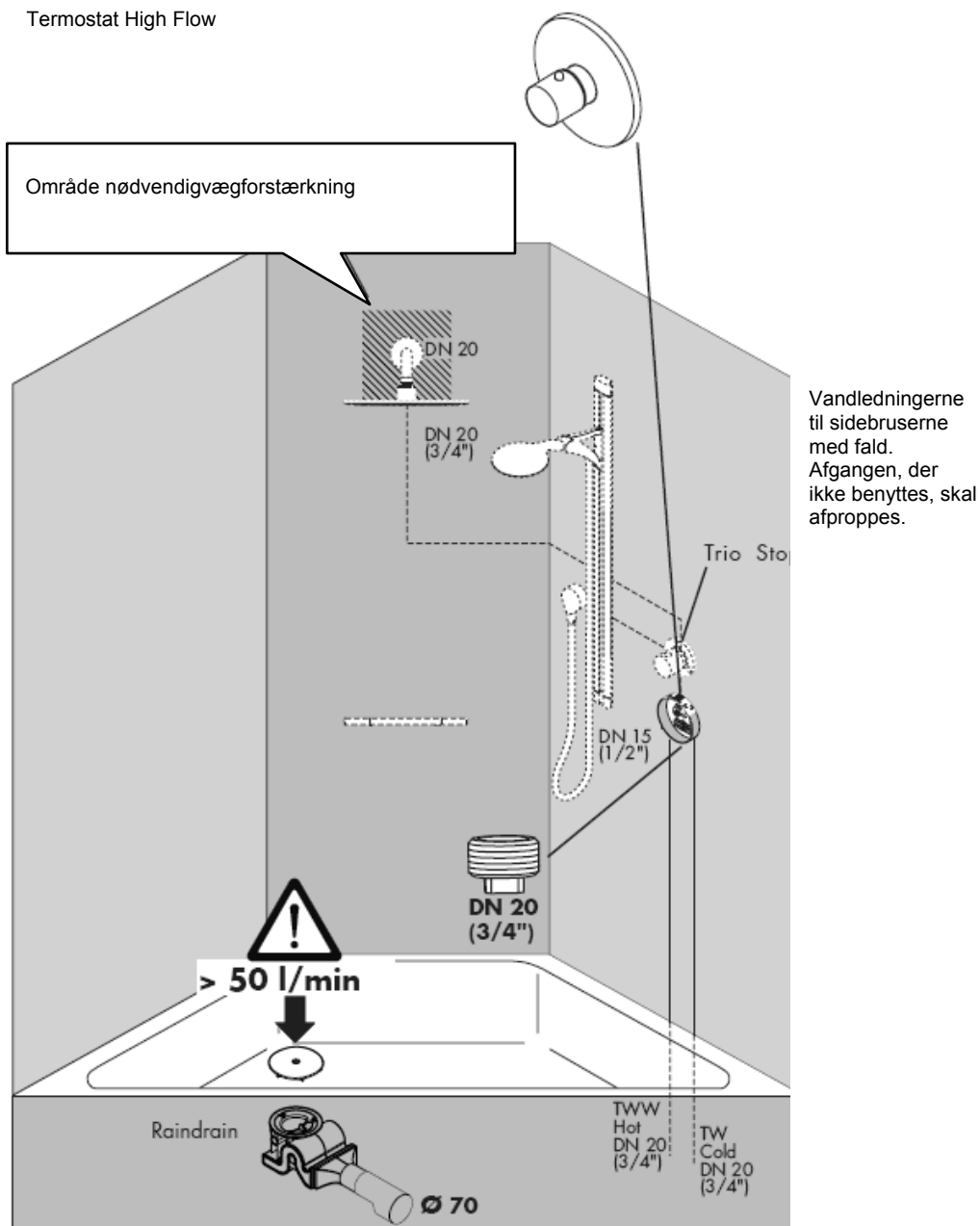

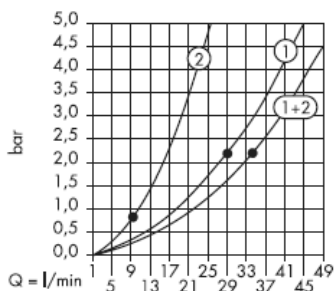

Fra • er funktionen anvendelig.

X = Midt brusekar

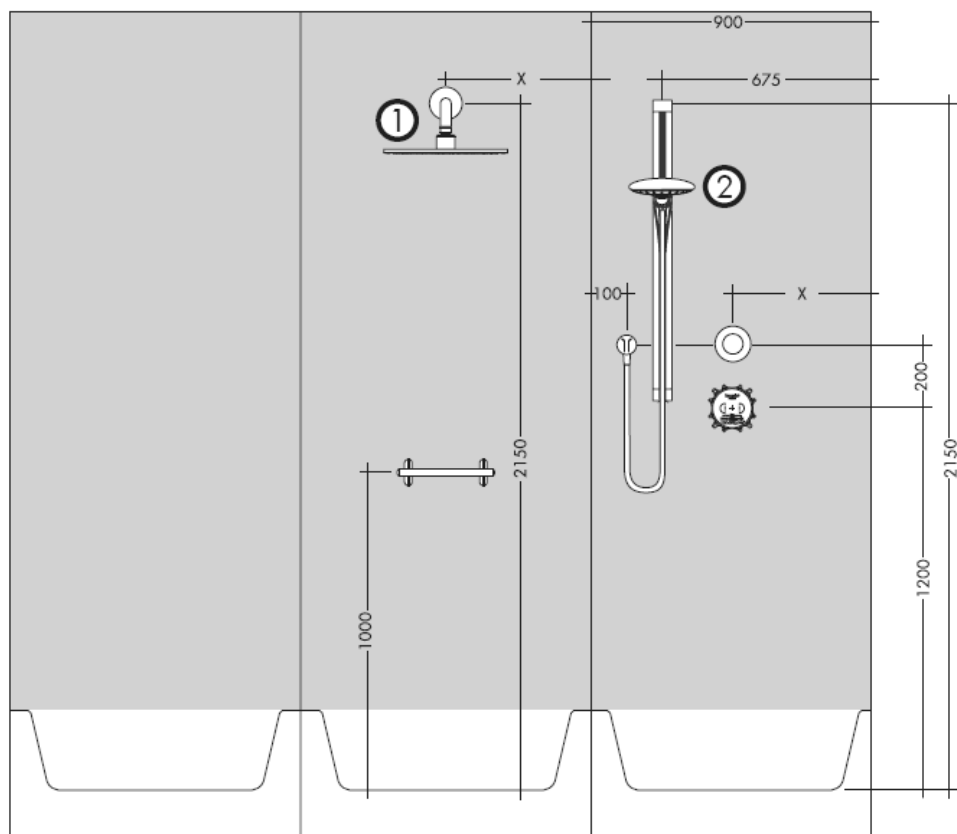

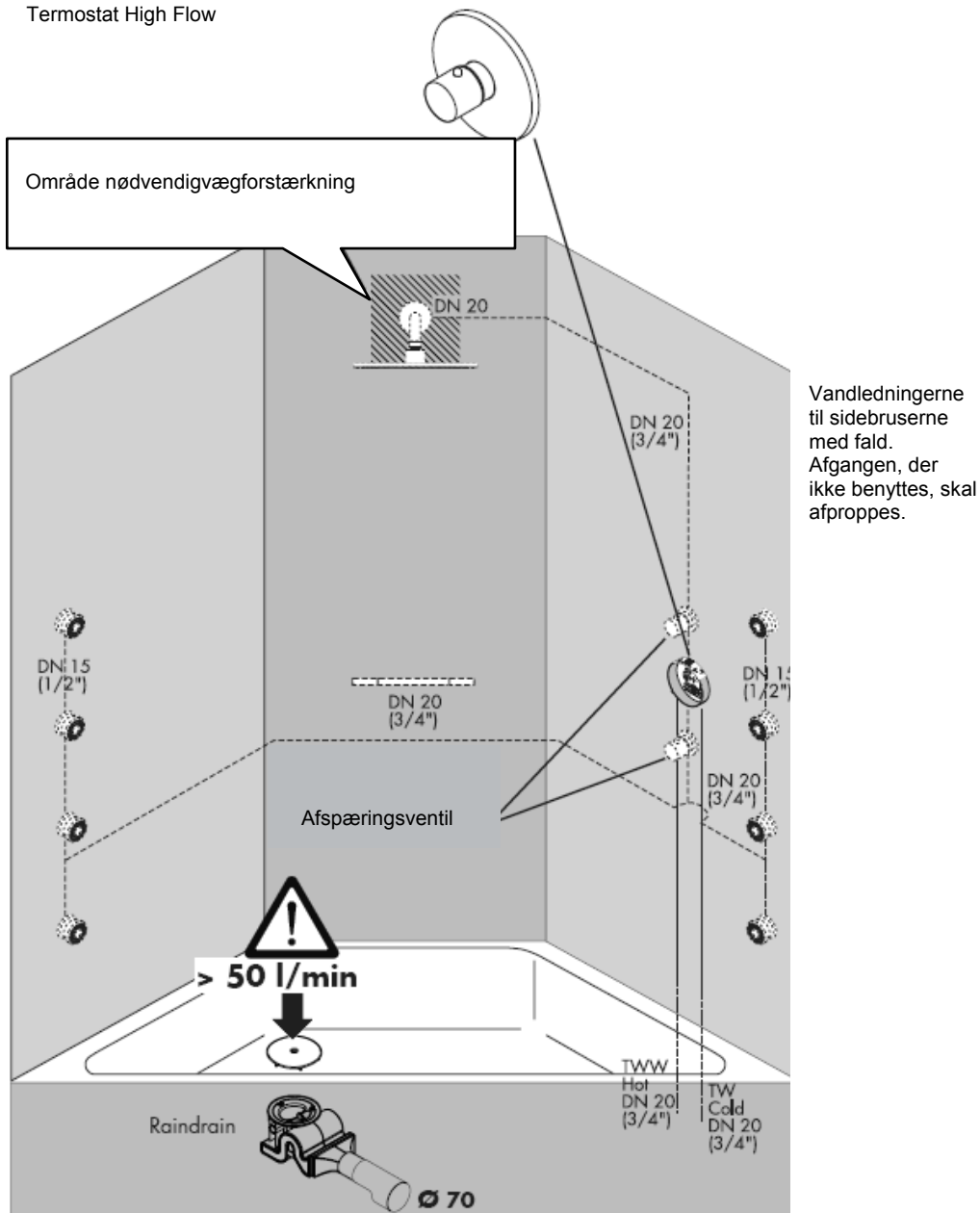

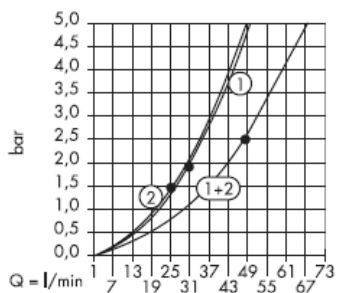

Fra • er funktionel.

X = Midt brusekar

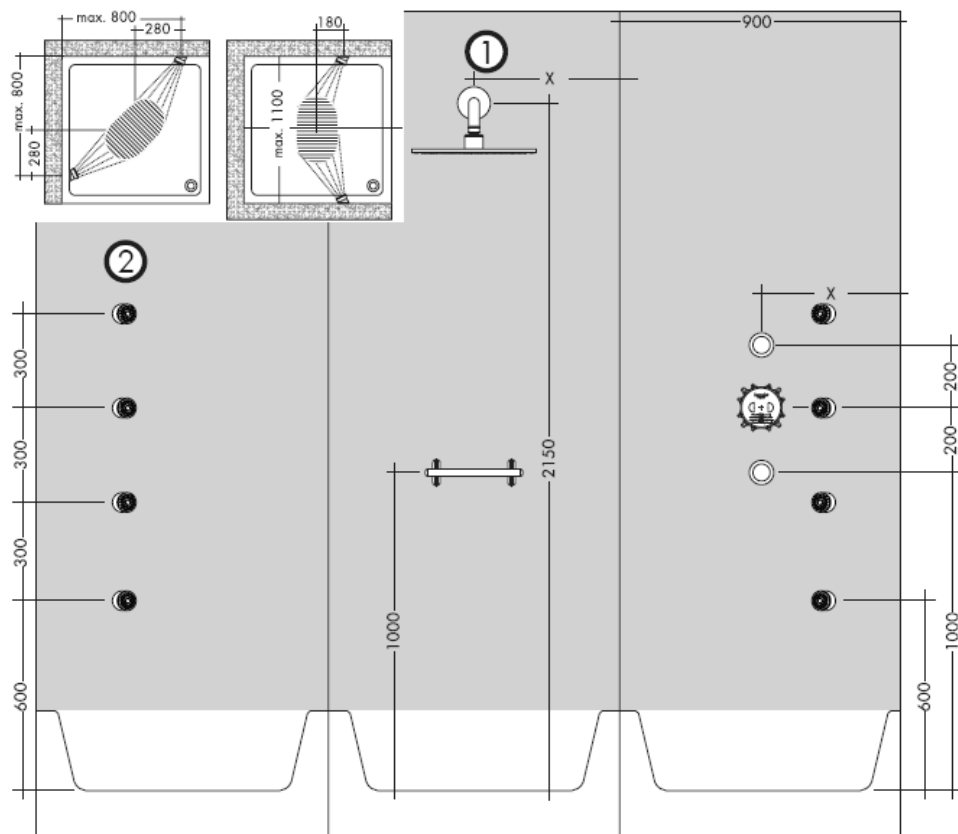

Termostat High Flow

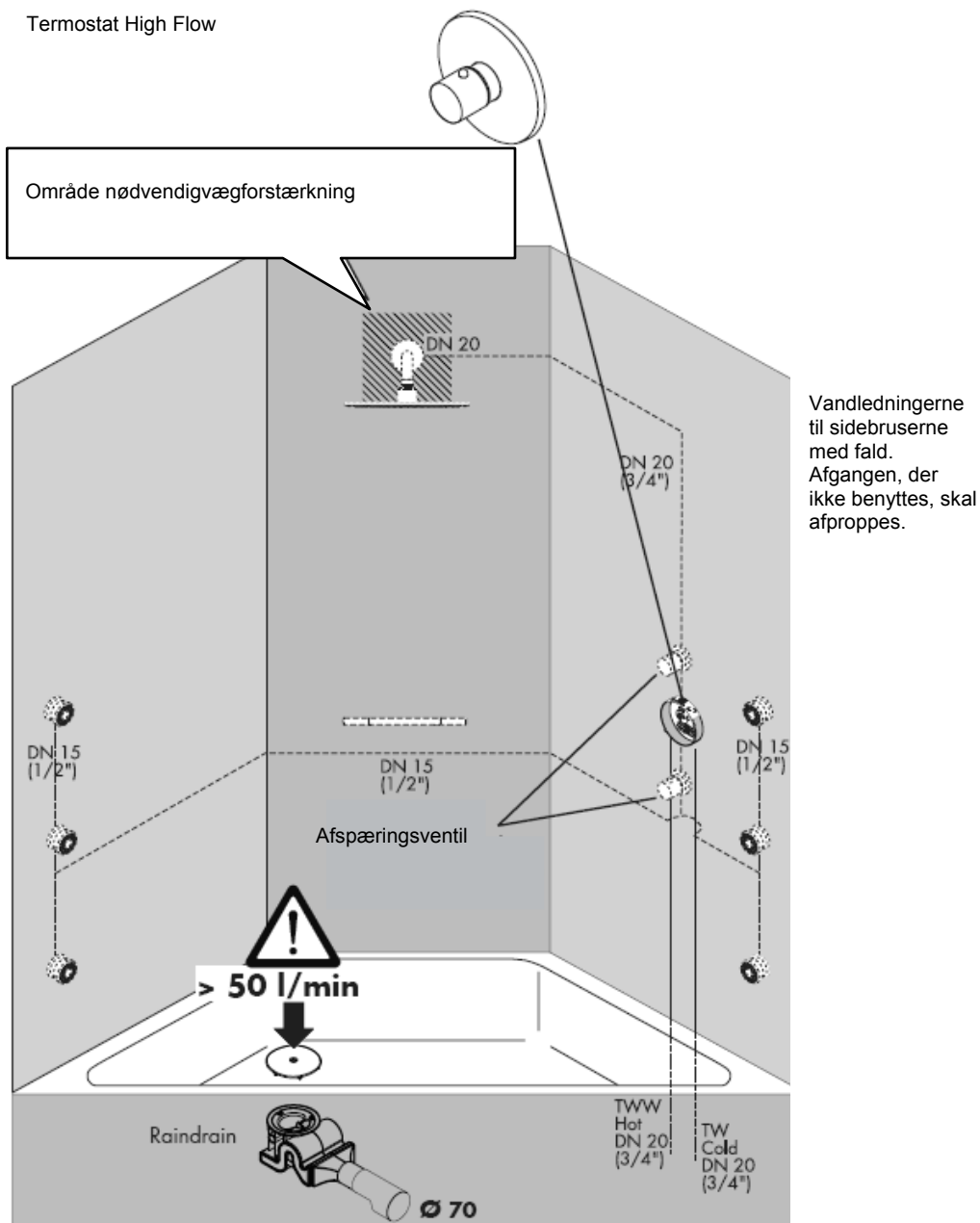

Vandledningerne til sidebruserne med fald. Afgangen, der ikke benyttes, skal afproppes.

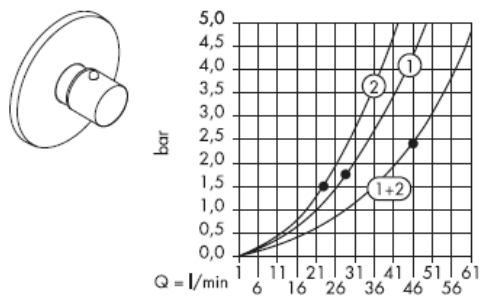

Fra • er funktionen anvendelig.

X = Midt brusekar

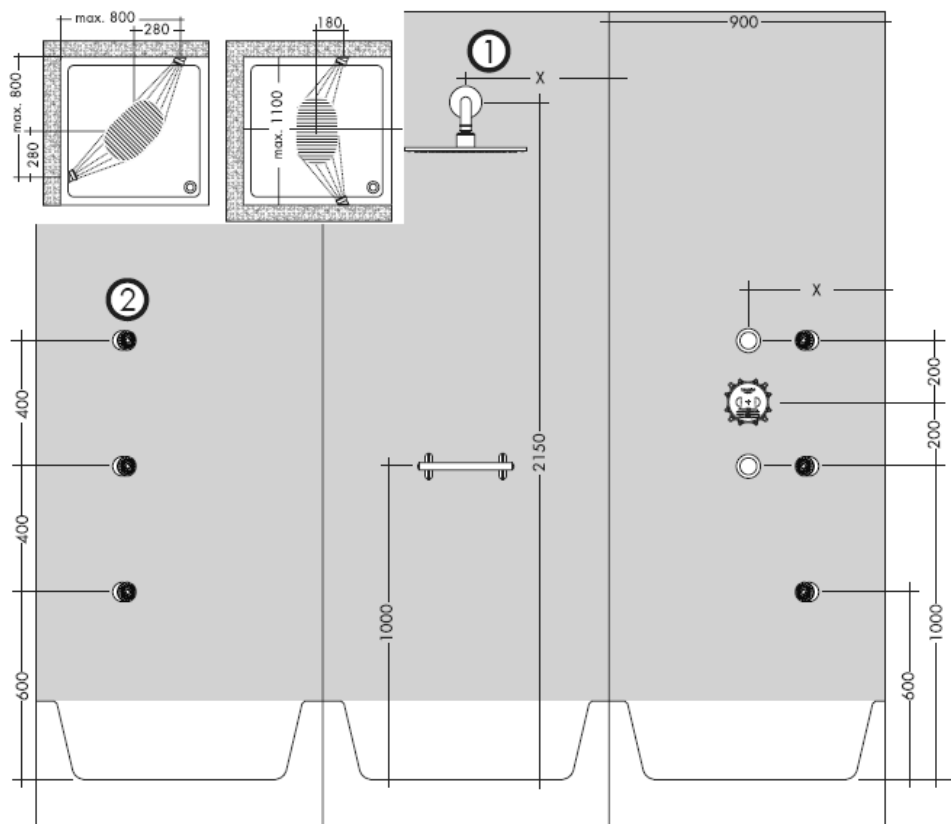

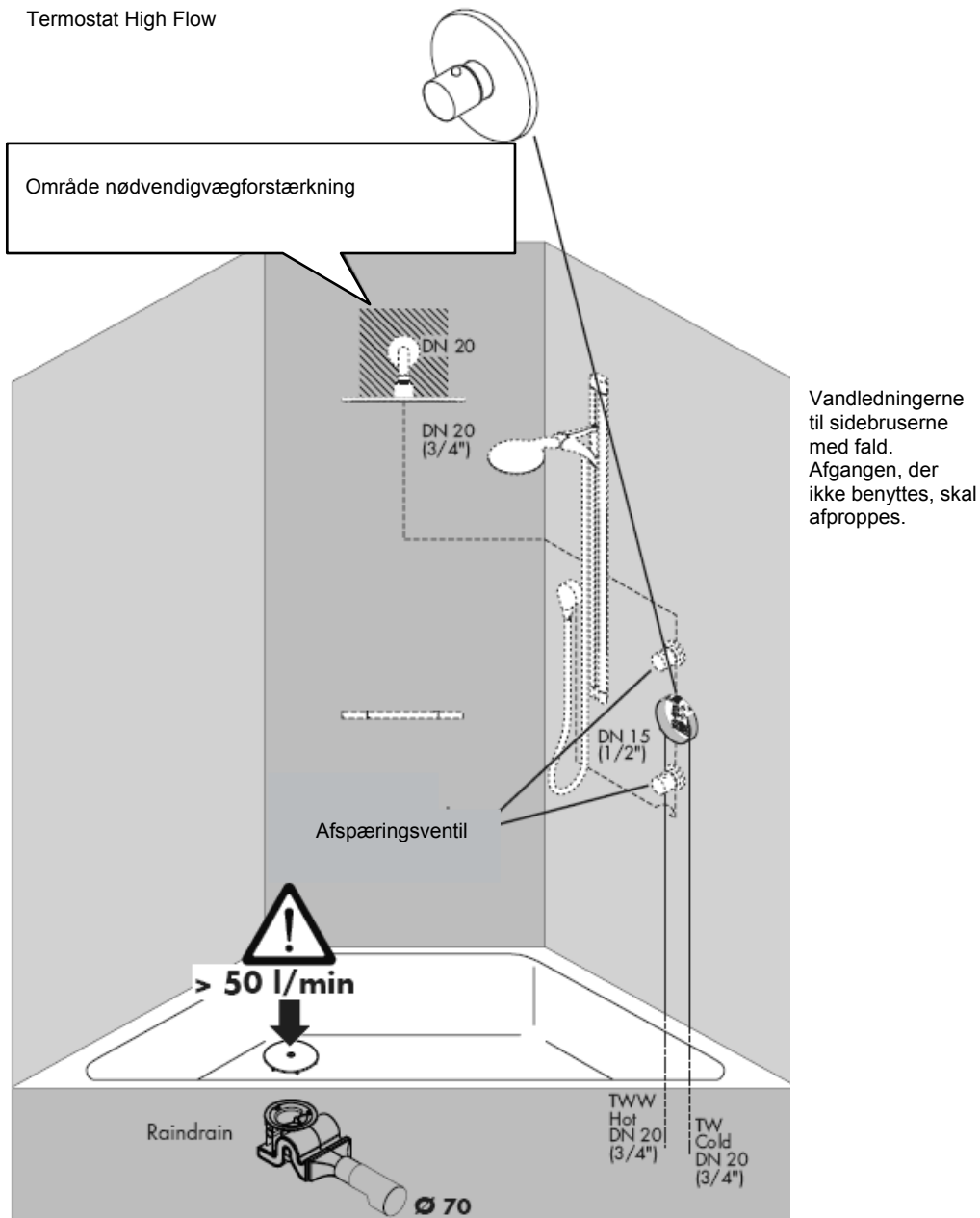

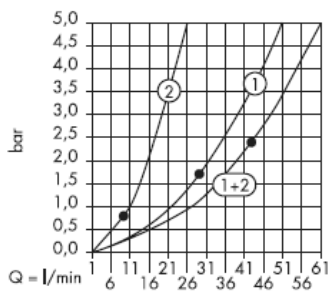

Fra • er funktionen anvendelig.

X = Midt brusekar

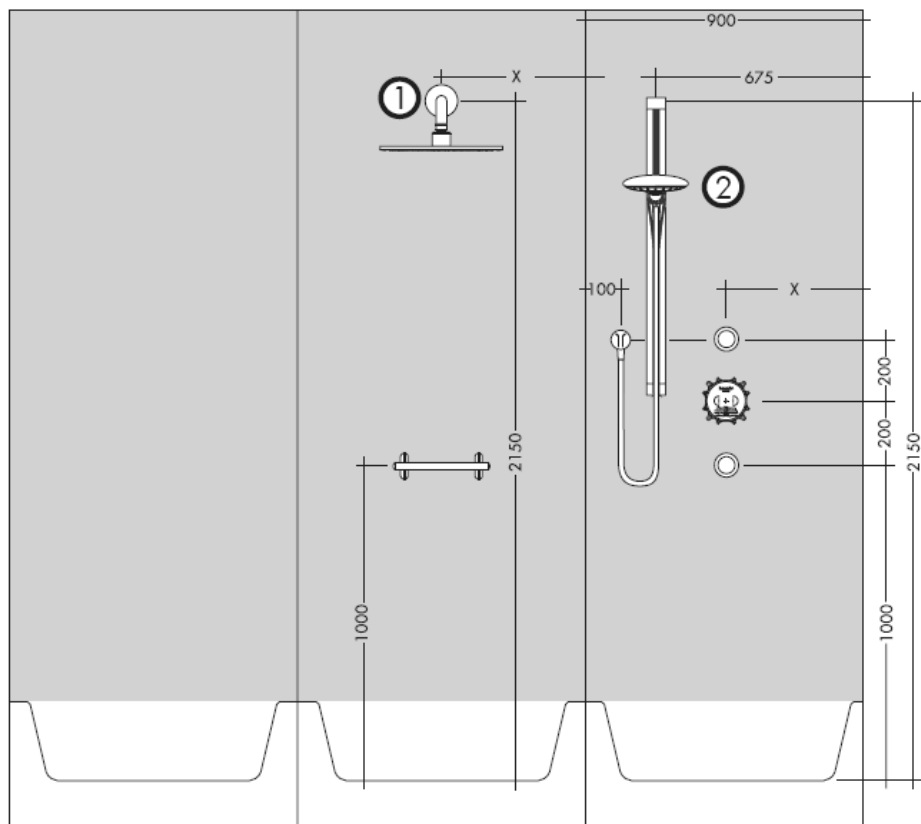

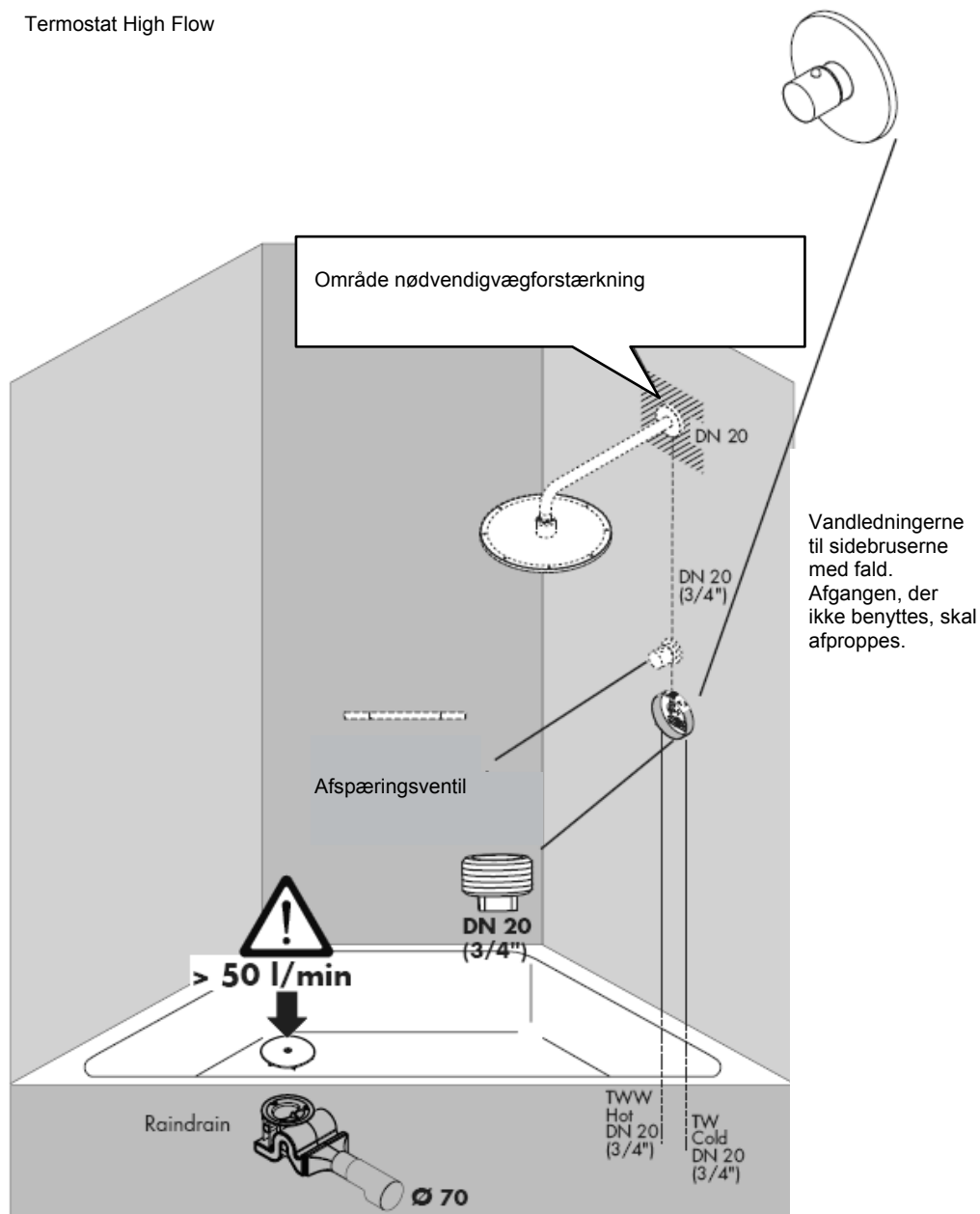

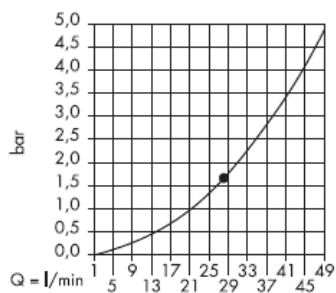

Fra • er funktionen anvendelig.

X = Midt brusekar

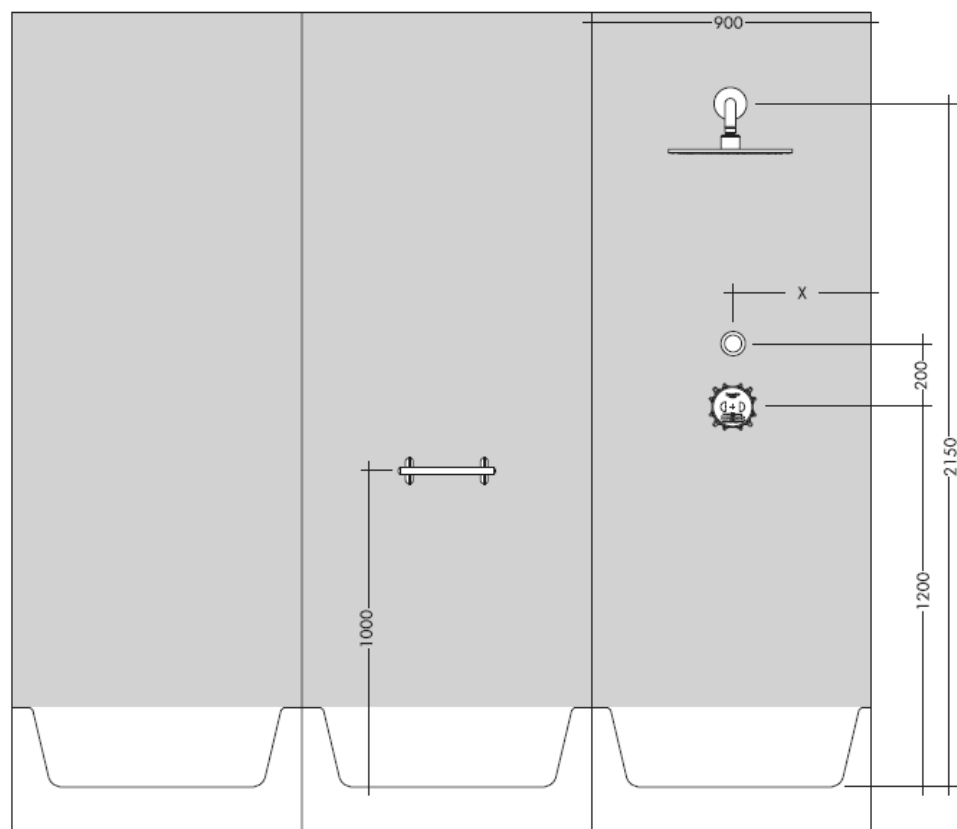

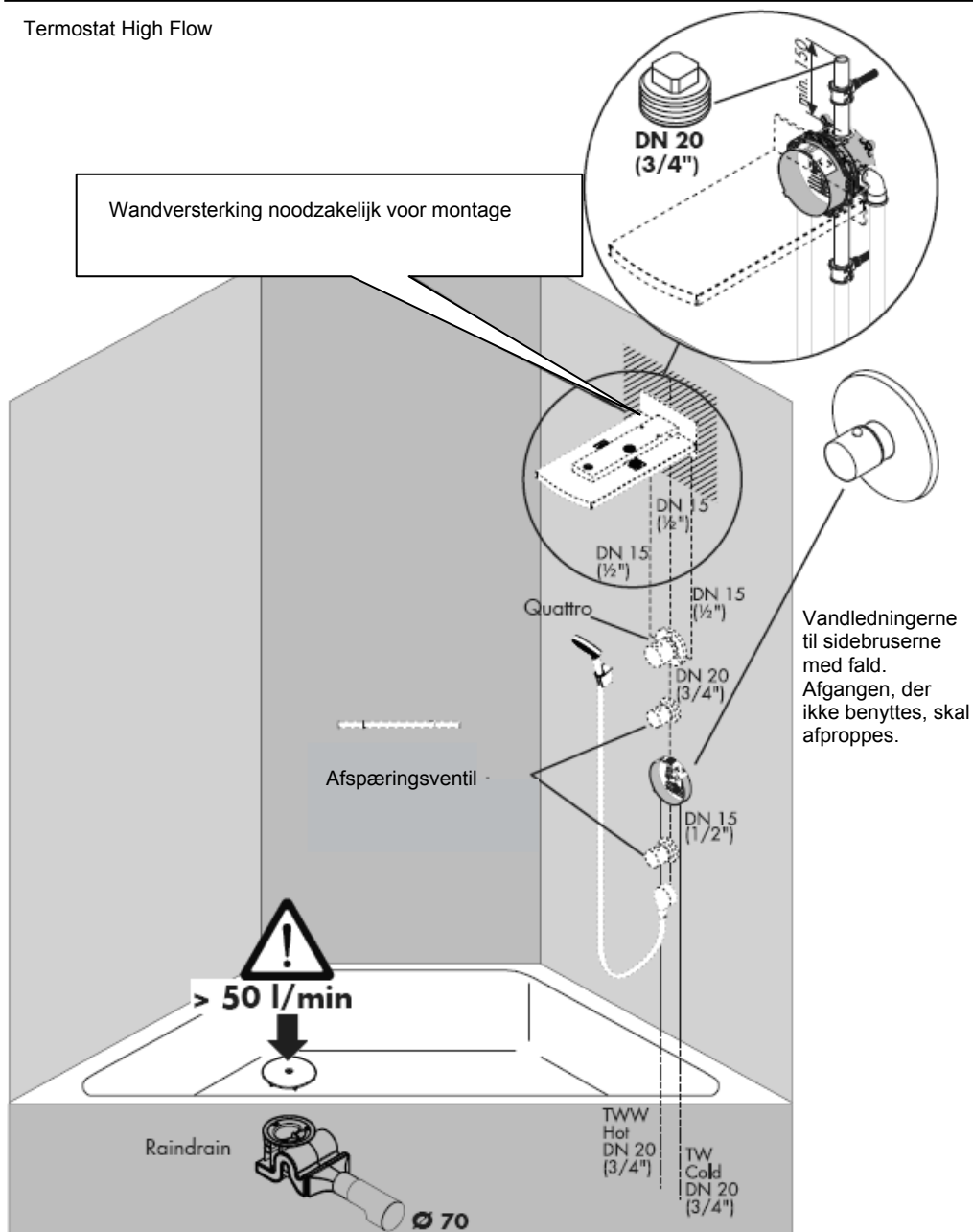

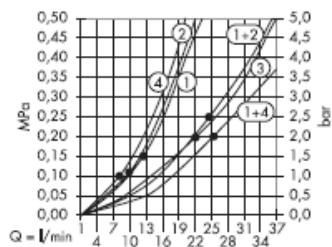

Fra • er funktionen anvendelig.

X = Midt brusekar

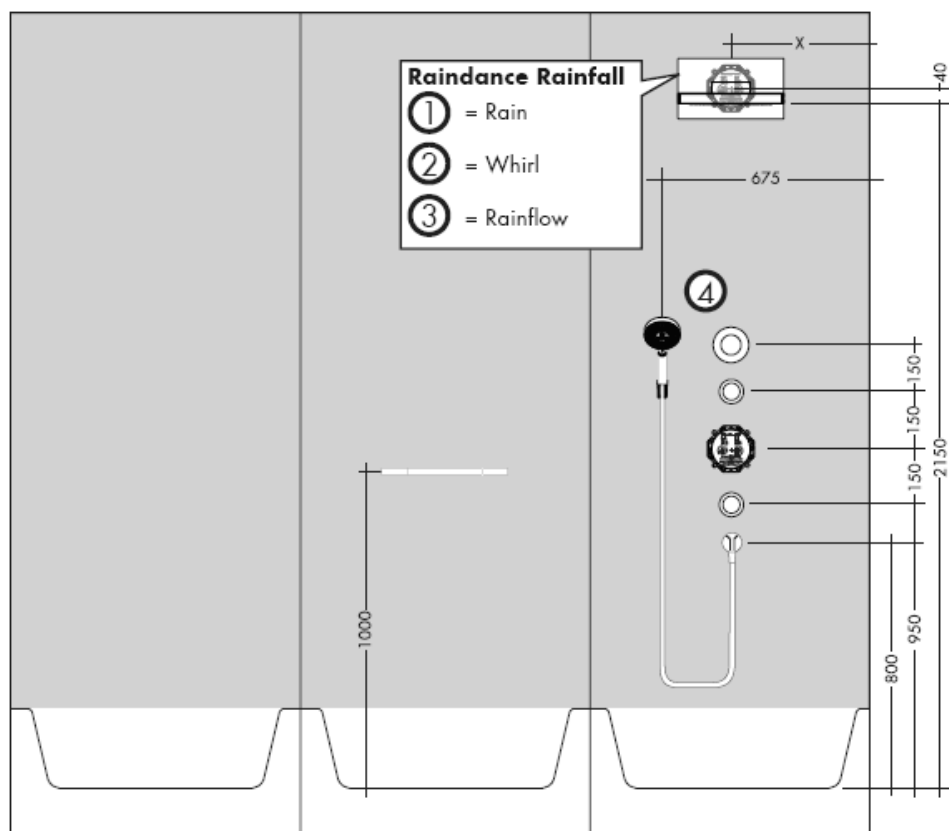

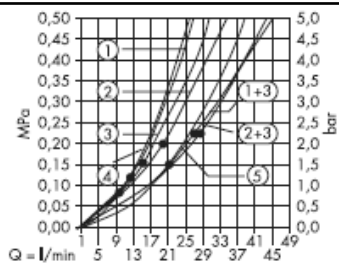

Fra • er funktionen anvendelig.

X = Midt brusekar

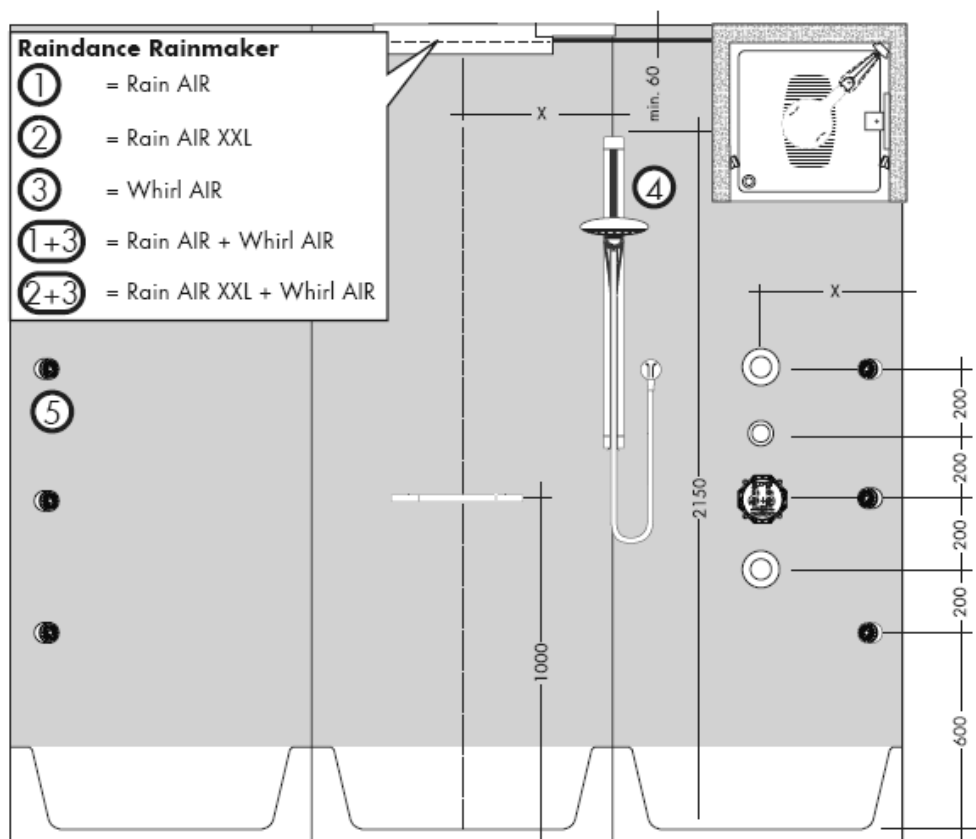

Termostat High Flow

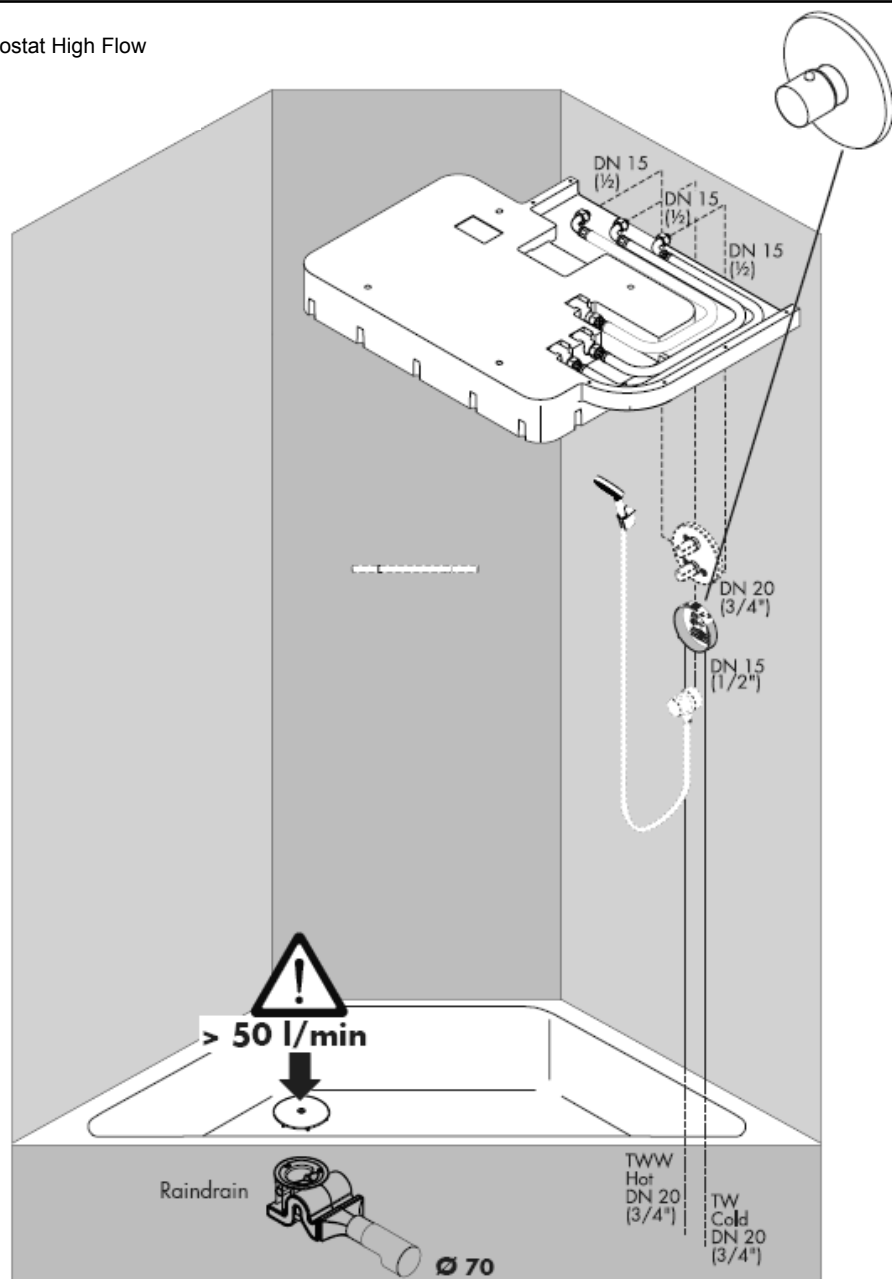

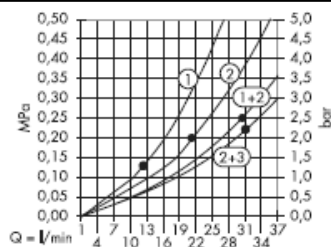
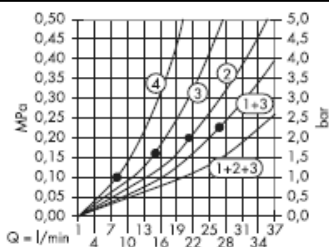

Fra • er funktionen anvendelig.

X = Midt brusekar

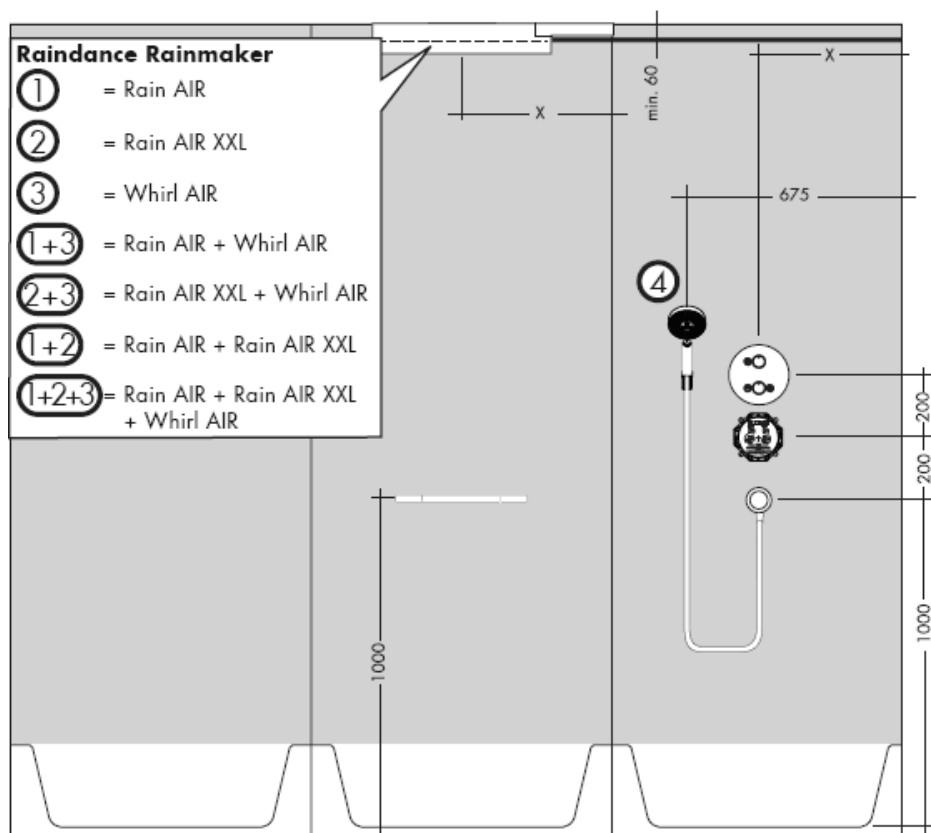

Monteringseksempler

Installation på væggen.

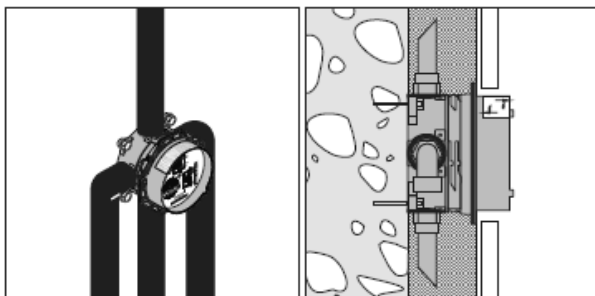

Installation på væggen. Her med fleksibel afstandsholder med 10 mm justerbar monteringskrue.

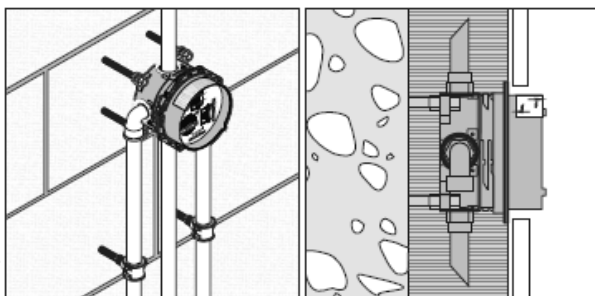

Installation foran væggen:
Montering på bæresystem.

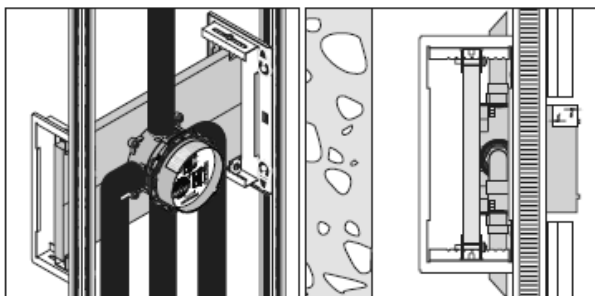

Installation på montageplade.

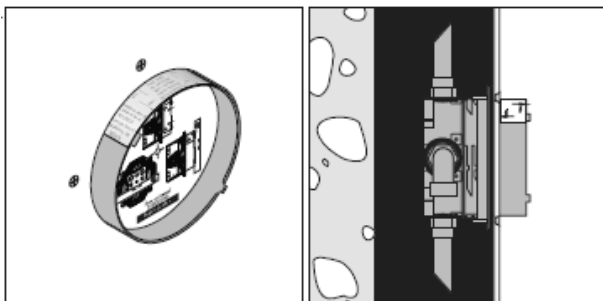

Installation direkte i væggen.

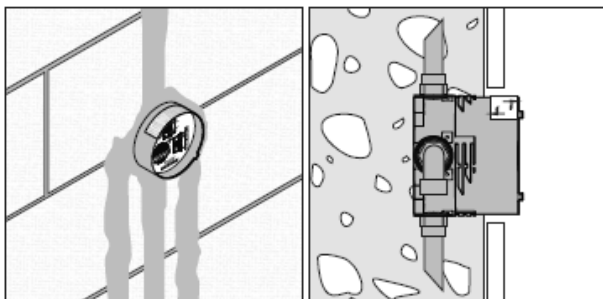

96615000

Installation med monterings-skinnesæt.

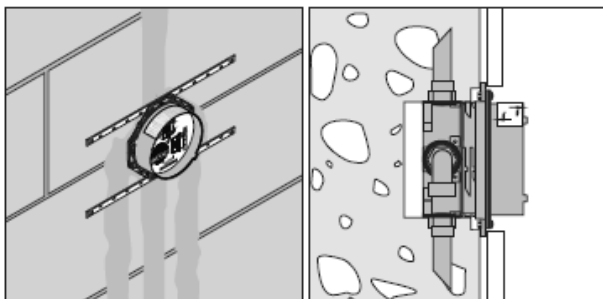

Råmontage

Grundkroppen indbygges således, at varmtvandstilslutningen er til venstre og koldt vandstilslutningen er til højre.

Monteringsdybde 80 mm til 108 mm.

(Forlængersæt 25 mm 13595000)

For monteringsseksempler se s. 126 og 127.

Iboxen er egnet til såvel kar- som til bruseinstallation. Ved 1-grebs karmatur er afgang 1 primærafgang. Ved bruseinstallation skal den overflødige afgang afropes.

Monterings-tips

For montering af tilslutningsvinkler, kan iboxen fastspændes i en skruetvinge ved hjælp af et rørstyrkke.

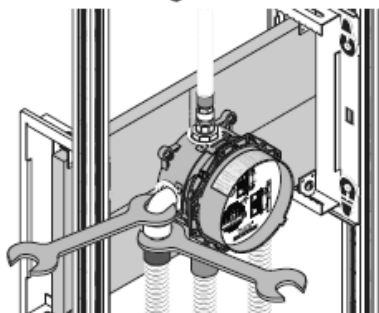
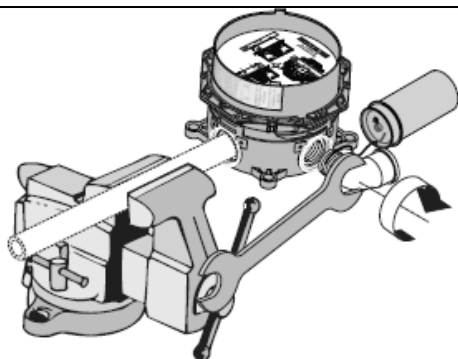
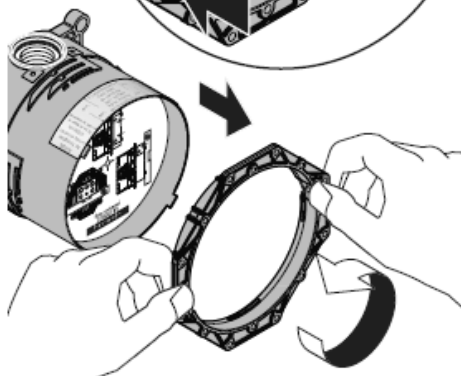
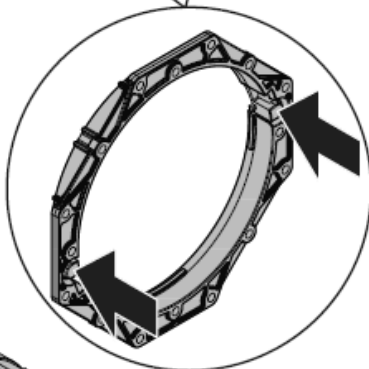
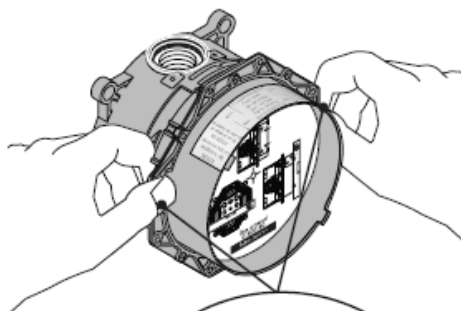
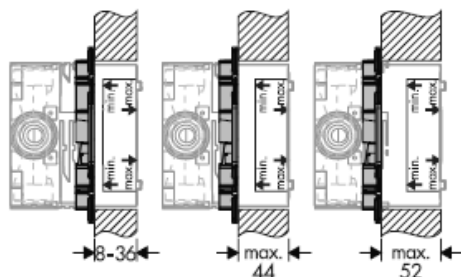

Gennemskylning

Den komplette installation skal gennemskyllles efter DIN 1988 / EN 1717. Pilene på tegningen viser, hvilke tilgange og afgange der er forbundet med hinanden, f.eks. varmt-vand med afgang. Efter første gennemskylning skal skylleblokken drejes hen på 90 grader.

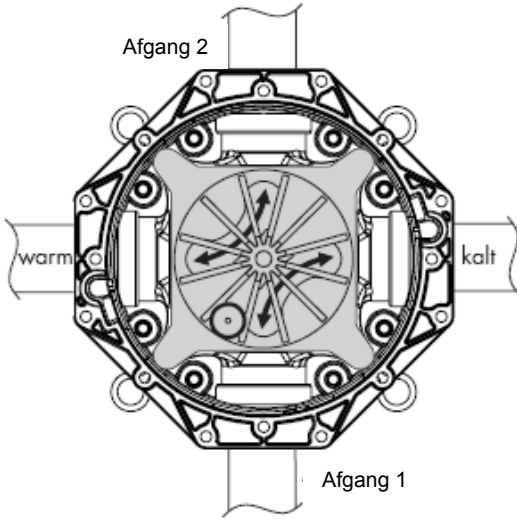

Tekniske data

| | |
|---|-----------------------------|
| Driftstryk: | Max 1,0 MPa |
| Anbefalet driftstryk: | 0,1 – 0,5 MPa |
| Prøvetryk: | 1,6 MPa |
| (1 MPa = 10 bar = 147 PSI) | |
| Varmtvandstemperatur: | max. 80° C |
| Anbefalet varmtvandstemperatur: | 65° C |
| Tilslutningsmål: | G 3/4" |
| Tilslutninger | Koldt højre - varmt venstre |
| Fri gennemstrømning ved 0,3 MPa: | |
| Kararmaturer Afgang Badekar | 31 l/min |
| Kararmaturer Afgang Bruser | 24 l/min |
| Brusearmaturer | 32 l/min |
| Termostat | 43 l/min |
| Termostat med afspæringsventil | 26 l/min |
| Termostat med afspæringsventil og omskifter | 26 l/r |
| Termostat High Flow | 58 l/min |

Godkendelse

| | | | | | | | |
|------|------|------|-----|----|------|------|----|
| DVGW | P-IX | SVGW | ACS | NF | WRAS | KIWA | DK |
| X | | X | | | | | |

Der pudses op omkring den indbyggede og afprøvede ibox universal; ved installation foran væggen sættes paneler op.

Når væggen er tør, fuges der med silikone (eddikesyre-fri) rundt om universal iboxens kappe.

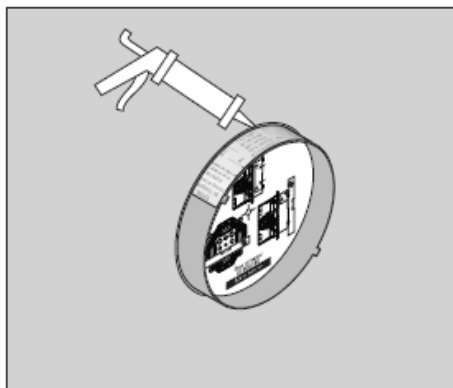

PCI Lastogum of een vergelijkbaar afdichtingsmateriaal (zie voorschriften fabrikant) op de wand aanbrengen.

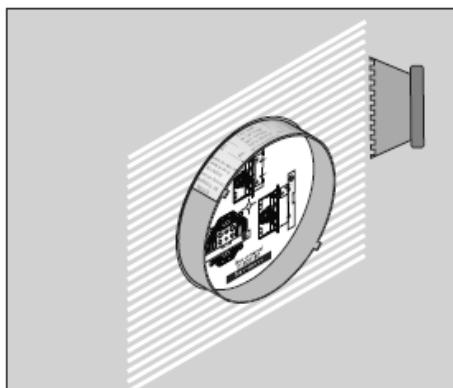

Tætningsmanchetten trækkes over universal iboxens kunststofkappe og trykkes fast i klæbemassen.

Advarsel! Der må ikke bruges smeltelim til tætningsmanchetten. Pas på ikke at beskadige universal iboxen med klæbemassen.

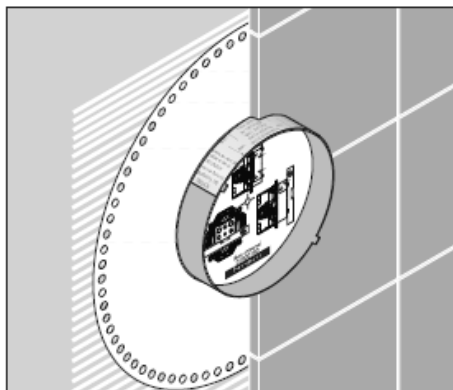

Ibox i kombination med Exafill påfyldnings- og overløbsgarniture

Der skal lukkes for vandet til Exafill ved monteringen.

Råinstallation

14. Installér universal iboxen (kun vertikal)
Ledningerne til Exafill monteres
15. Gennemskyl rørsystemet. se s.

Montering af badekar

43. Exafill monteres på karet og ledningssystemet forbindes
44. Exafill rørsystemet gennemskylles og afprøves for tæthed
45. Luk for hovedhanen
46. Demonter skylleblokken
47. Proppen (A) sættes ind i afgangen til Exafill
48. Montér skylleblokken
49. Tænd for vandet

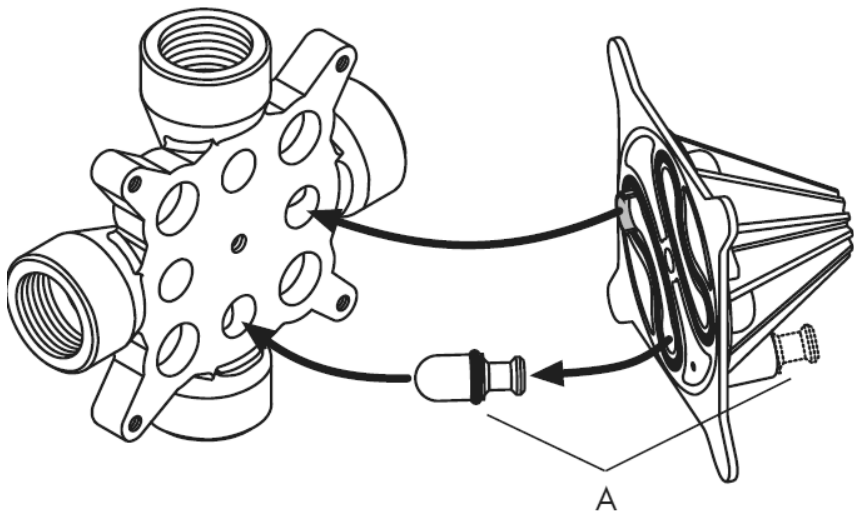
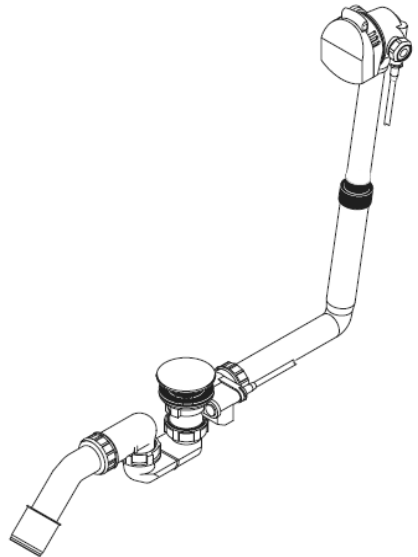

hansgrohe