

DE	Montageanleitung	2
FR	Instructions de montage	5
EN	assembly instructions	8
IT	Istruzioni per Installazione	11
ES	Instrucciones de montaje	14
NL	Handleiding	17
DK	Monteringsvejledning	20
PT	Manual de Instalação	23
PL	Instrukcja montażu	26
CS	Montážní návod	29
SK	Montážny návod	32
ZH	组装说明	35
RU	Инструкция по монтажу	38
HU	Szerelési útmutató	41
FI	Asennusohje	44
SV	Monteringsanvisning	47
LT	Montavimo instrukcijos	50
HR	Uputstva za instalaciju	53
TR	Montaj kılavuzu	56
RO	Instrucțiuni de montare	59
EL	Οδηγία συναρμολόγησης	62
SL	Navodila za montažo	65
ET	Raigaldusjuhend	68
LV	Montāžas instrukcija	71
SR	Uputstvo za montažu	74
NO	Montasjeveiledning	77
BG	Инструкция за употреба	80
SQ	Udhëzime rreth montimit	83
AR	تعليمات التجميع	88

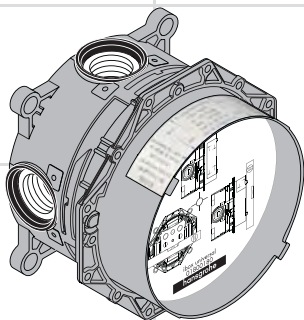

iBox universal

01800180





Råmontasje

Det rotasjonsymetriske basiselementet til iBox kan brukes universelt dvs. horisontalt og vertikalt. Et unntak er ved montasje av kararmatur med sikkerhetskombinasjon. Da er det kun mulig med vertikal montasje. Ettersom det kan lekke vann ut av iBoxen ved en defekt, skal iBoxen monteres over badekaret, slik at vannet som lekker ut kan renne ned i badekaret.

iBoxen egner seg både for installasjon på dusj eller badekar. Ved enhånd-blandebatteri for badekar / termostat med sperre- og omstillingsventil prioriteres nedre utgangen. Dersom kun en utgang brukes, kan det valgfritt kobles til øvre eller nedre utgang. Utgangen som ikke brukes må tettes med en plugg.

Store trykkdifferanser mellom kaldt- og varmtvannstilkoblinger skal utlignes.

Basiselementet bygges inn slik at varmtvannstilkobling er på venstre og kaldtvannstilkobling er på høyre side.

Innbyggingsdybde 80 mm til 108 mm.

Forlengelse 25 mm: #13595000

Forlengelse 22 mm (ved liten montasje dybde):

#13593000 / #13596XXX / #13597XXX /

#15597000 / #19427000 / #97407XXX /

#98860000 / #13601000 / #13604000

Basiselementet kan monteres iht. byggmessige forhold, se montasje-eksempel på side 62 og 63.

A Installasjon på vegg

B Installasjon på vegg. Her med fleksible avstandsholdere via spesialskrue.

C Montasje på bæresystem.

D Installasjon på ferdighus-montasjeplater eller prefabrikkert celler.

E Installasjon rett på vegg.

F Installasjon med sett av montageskinner #96615000

Installasjonseksempel med målangivelser og ledningsdimensjoner finns fom. side 68. Forklaring for brukte symboler på side 67.

Monteringsmål i monteringsveiledningen er beregnet for personer som er omtrent 1800 mm høye, målene skal eventuell tilpasses om nødvendig. Her skal man passe på at ved endrede monteringsmålene blir minstehøyden endret, og det må tas hensyn til de endrede tilkoblingsmålene. Forbruksverdiene måles ved normal bruk med tilhørende armatur (temostat/blandebatteri/innmurt ventil).

Montasje-tipp

For å skru inn koblinger skal iBoxen settes fast i en skrutikke ved hjelp av et røt.

Spyle

Komplett installasjon spyles iht. DIN 1988 / EN 1717. Pilene på spyleblokken indikerer hvilke tilløp som er koblet sammen med hvilken utgangsledning, f.eks. kaldtvann med utgang 1 og varmtvann med utgang 2. Hvis det kun er nødvendig med en utgang, skal spyleblokken dreies med 90° etter den første spylingen.

iBox i kombinasjon med Exfill karinnløp med avløps- og overflytgarnityr (se side 66)

Tekniske data

Driftstrykk	maks. 1 MPa
Anbefalt driftstrykk:	0,1 - 0,5 MPa
Prøvetrykk	1,6 MPa
(1 MPa = 10 bar = 147 PSI)	
Varmtvannstemperatur	maks. 70 °C
Anbefalt temperatur for varmt vann	65 °C
Tilkoblingsmål:	R $\frac{3}{4}$
Tilkoblinger:	kaldt høyre - varm venstre
Fri gjennomstrømning ved 0,3 MPa:	
Dusj-blandebatteri:	32 l/min
Termostat:	37 l/min
Termostat med sperreventil:	26 l/min
Termostat med sperre- og omstillingsventil:	26 l/min
Termostat Highflow (Utgang 1+2):	58 l/min
iControl:	30 l/min
Blandebatteri for badekar:	31 l/min // 24 l/min
Blandebatteri for badekar med integrert sikkerhetskombinasjon:	25 l/min // 24 l/min



**X**

Midten av badekaret / Midten på dusjkar



Innfelt ventil

YMål Y = Midten til slangetilkoblingsbue
t.o.m. badekarinnløp delt på 2 (eventuelt
skal fliseraster tilpasses).

Quattro fire-veis omstilling

Quattro

Varmtvann



Trio universal stenge- og omstillingsventil



Kaldtvann

**Trio**

F.o.m. • er funksjonen garantert



Innløp badekar



I dette området skal veggen forsterkes.

Utgangen som ikke brukes kan tettes med
en blindplugg. (DN 20 3/4")

Kun en forbruker mulig, ikke to samtidig.



Avløp ytelse skal være mer enn 50 l/min.

> 50 l/minVannledninger for sidedusjer installeres
med fall.

Avløp

**Raindrain**Spyleblokk kpl. #15956000, ikke med i
leveransen**Exafill**iBox i kombinasjon med Exfill karinnløp
med avløps- og overflytgarnityr (se side
66)

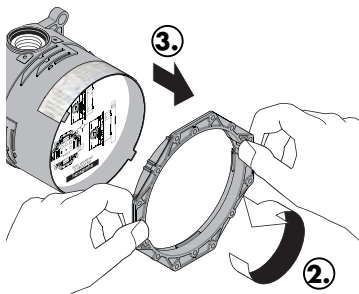
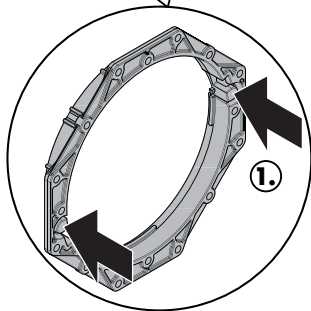
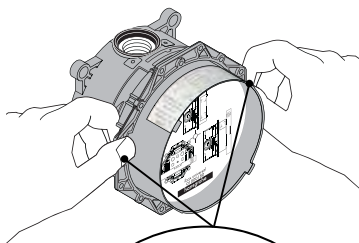
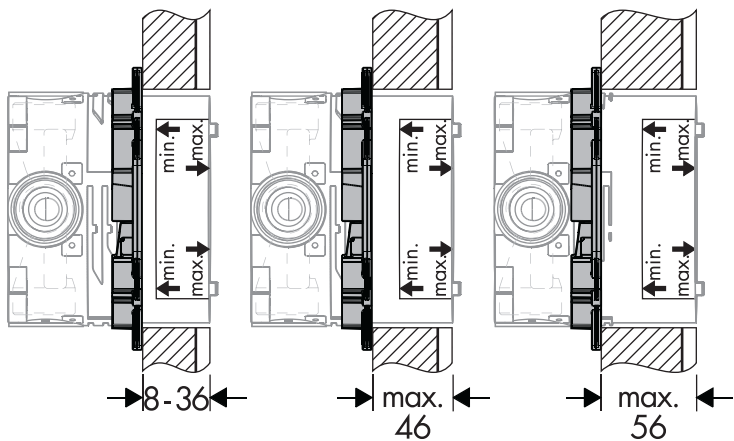

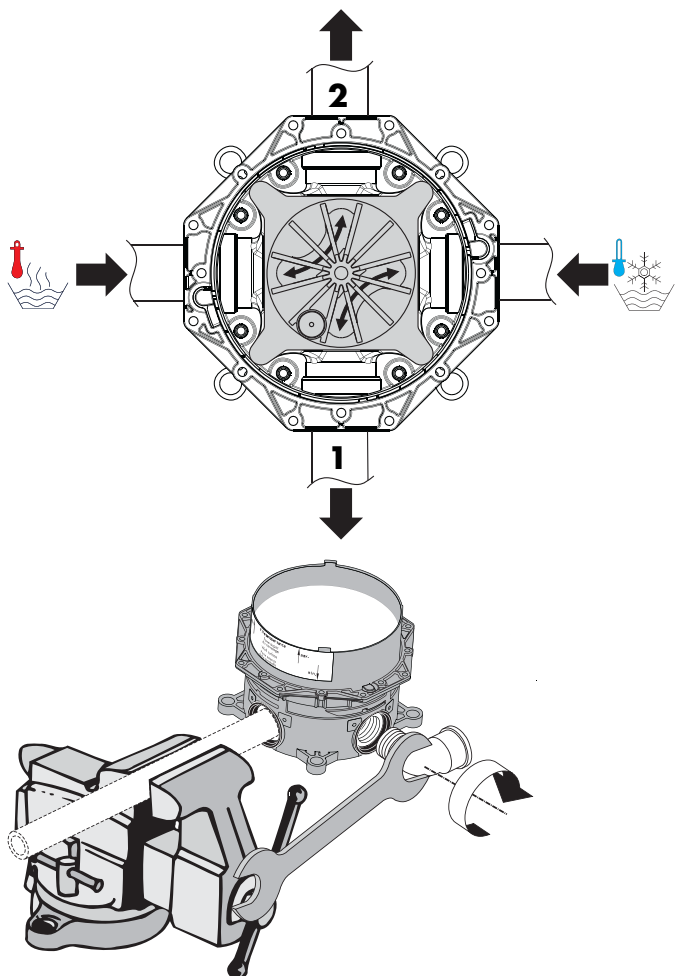

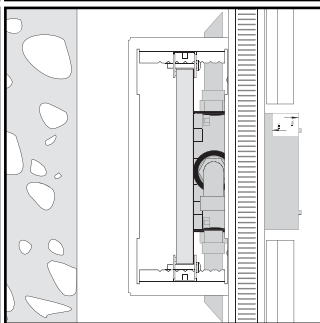
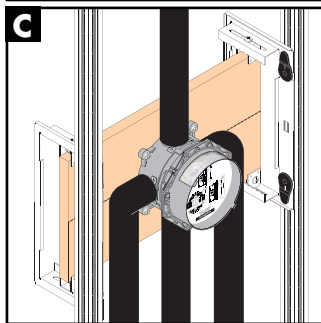
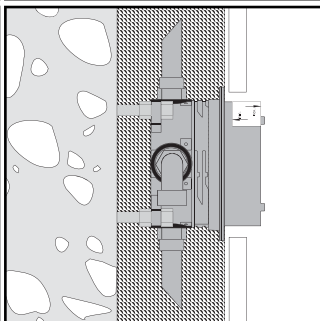
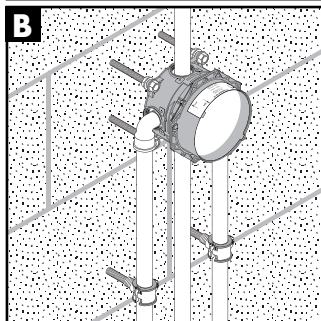
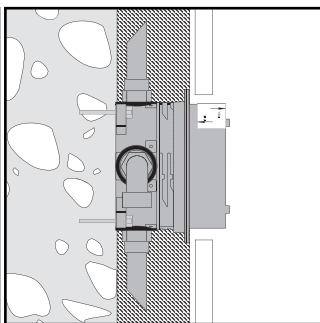
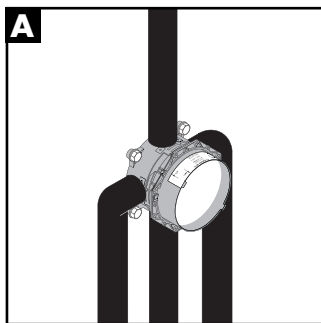

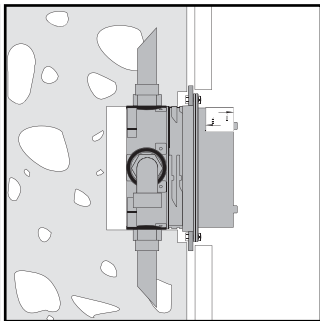
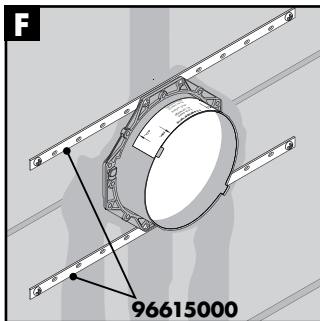
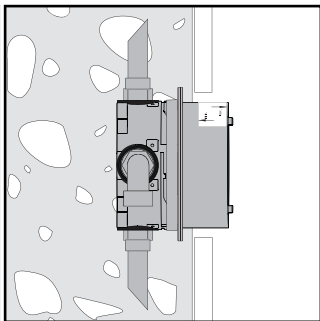
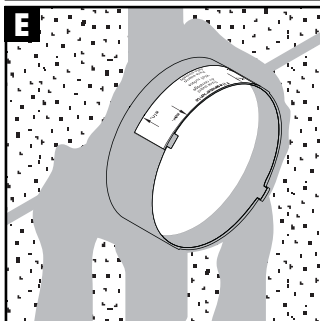
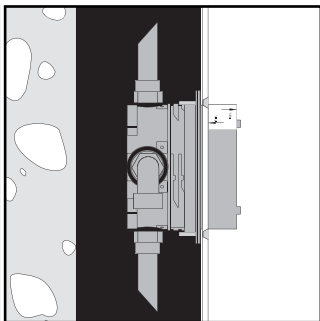
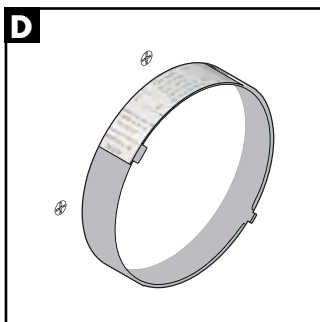

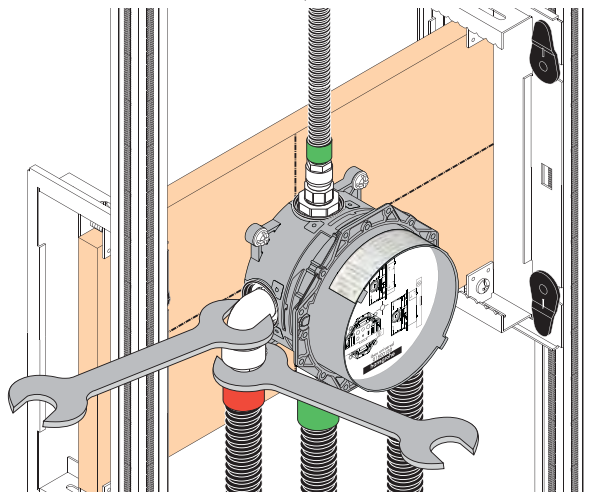
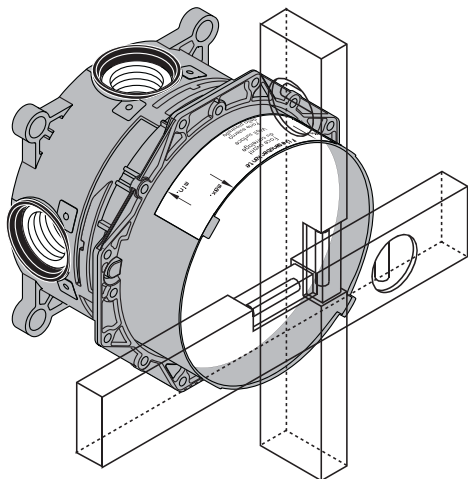

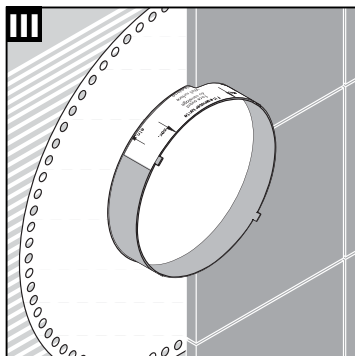
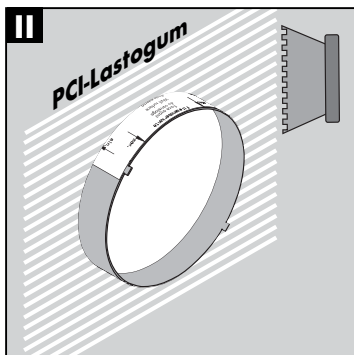
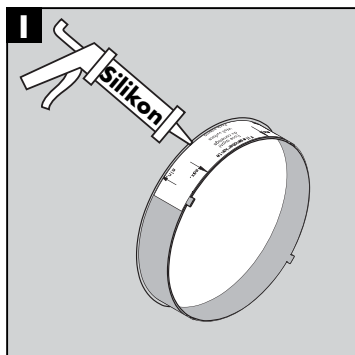



Prüfzeichen / Classification acoustique et débit / Test certificate / Segno di verifica / Marca de verificaci3n /
 Keurmerk / Godkendelse / Marca de controlo / Znak jakości / Zkušební značka / Osvedčenie o skúške / 检验标
 记 / Знак технического контроля / Vizsgajel / Koestusmerkki / Testsigill / Bandyto pažyma / Oznaka testiranja /
 Kontrol isareti / Certificat de testare / Σήμα ελέγχου / Preskusni znak / Kontrollsertifikaat / Pārbaudes zīme / Ispitni
 znak / PrøveMERKE / Контролен знак / Shenja e kontrollit / شهادة اختبار

DVGW SVGW WRAS KIWA ACS NF  ETA

BP5615 X X X X X 1402  1.43/18753



iBox universal + Exafill

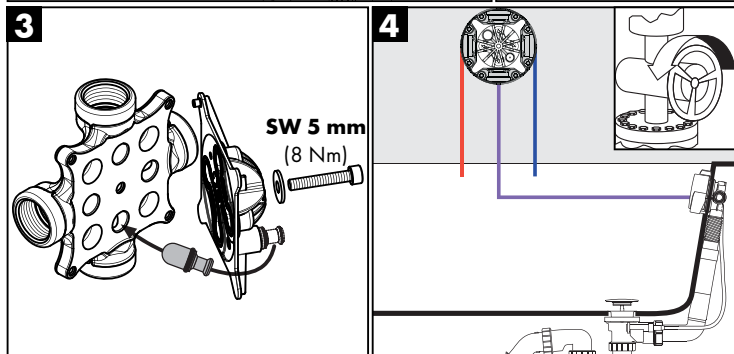
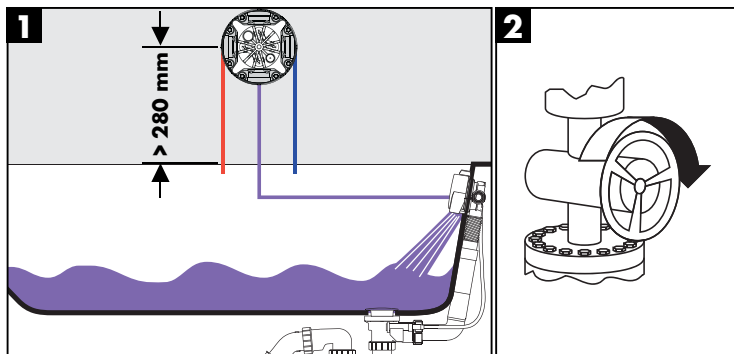
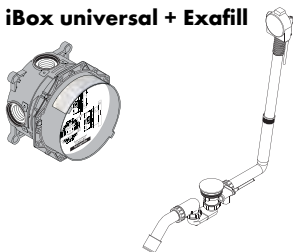

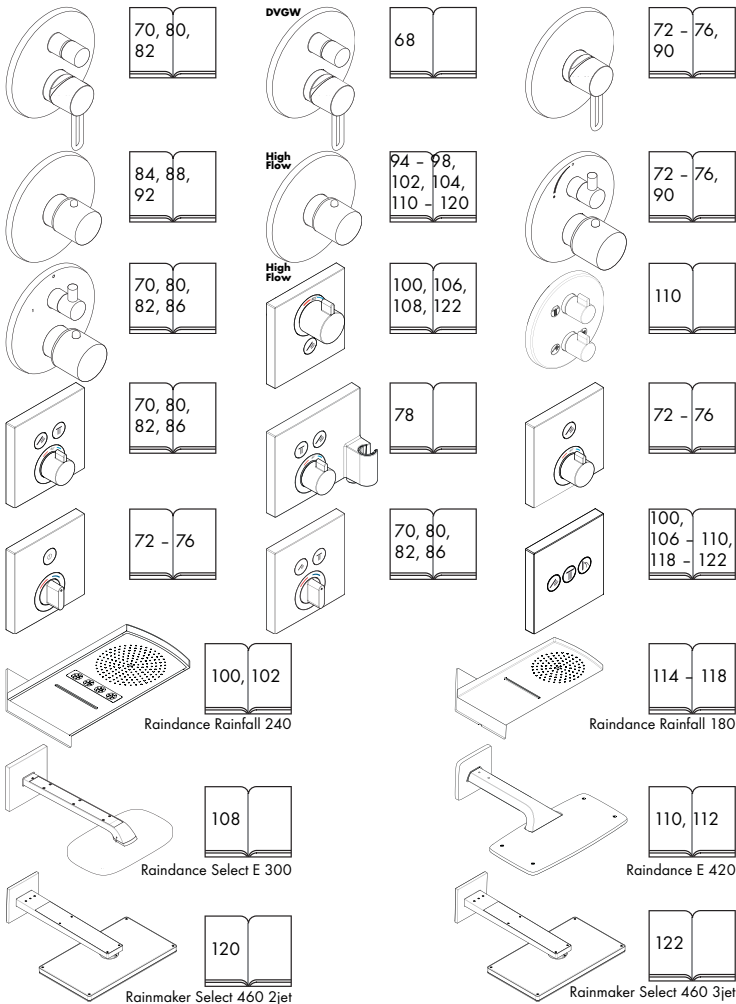

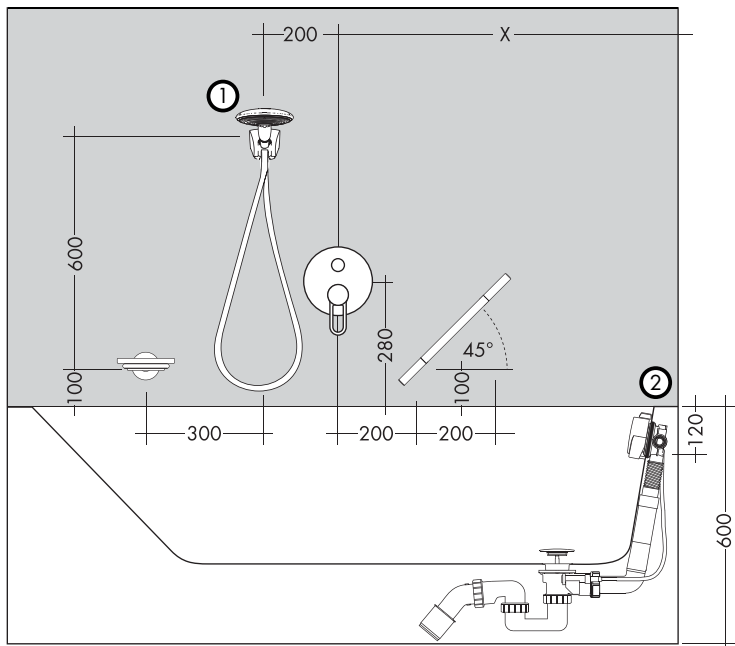
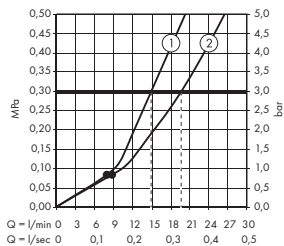

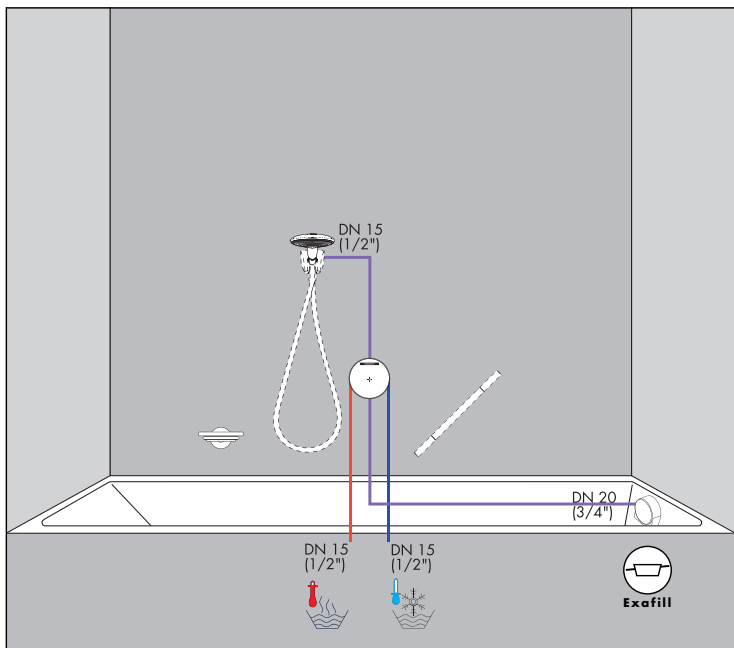

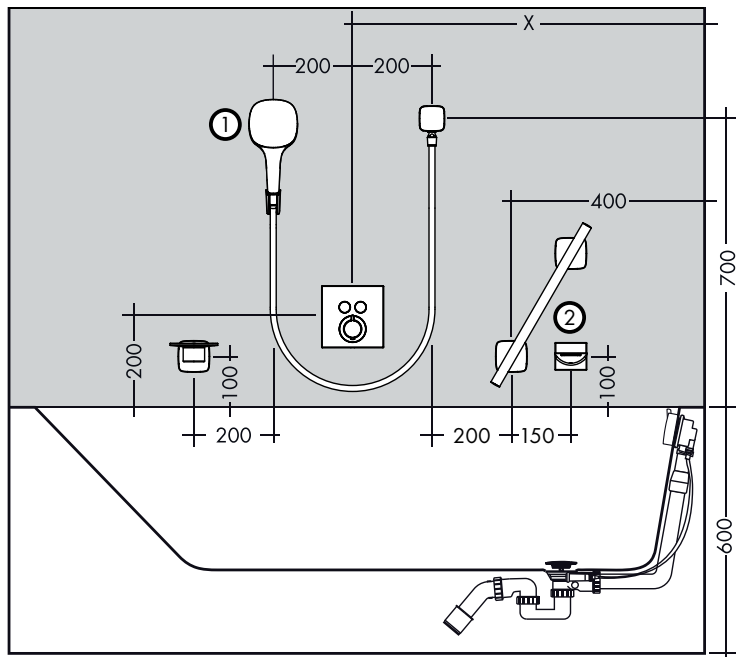
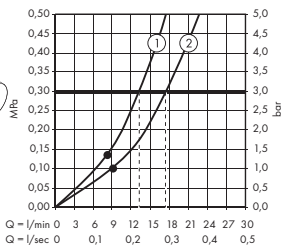
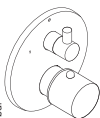
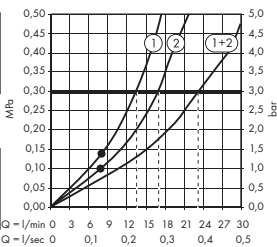
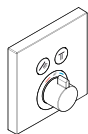

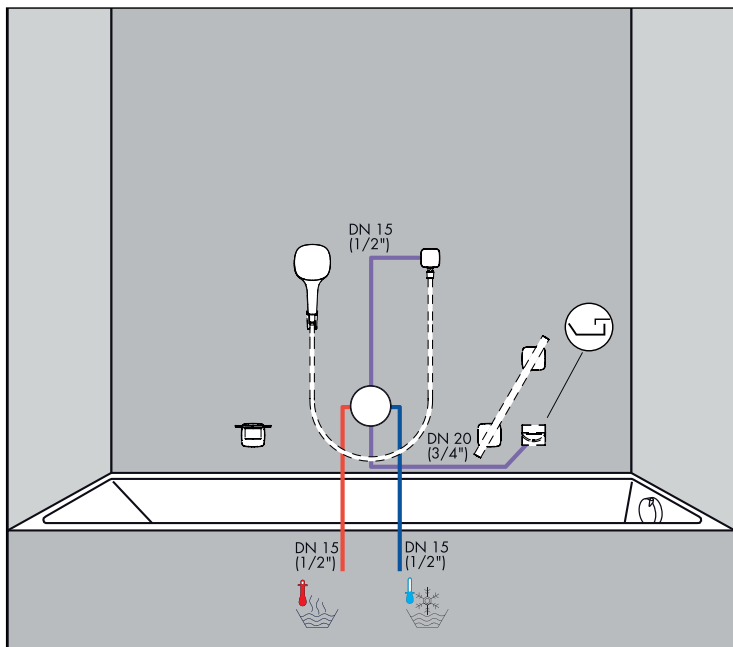
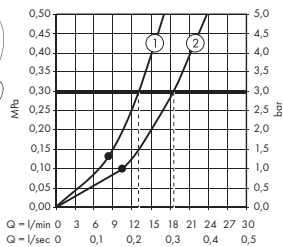

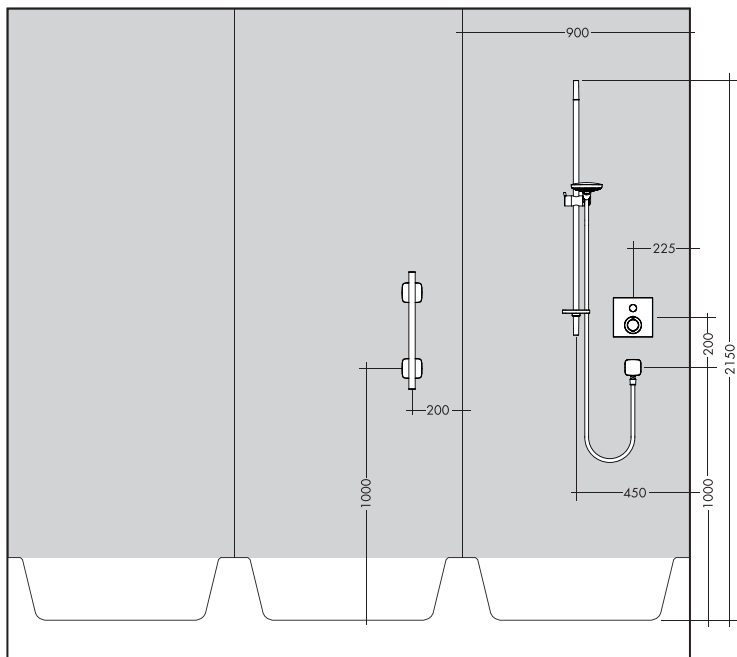
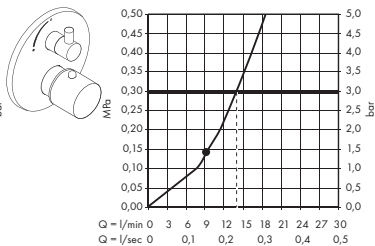
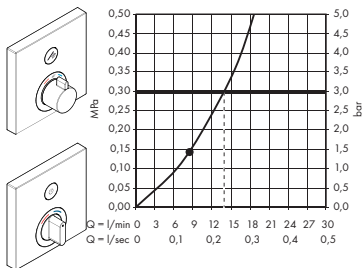

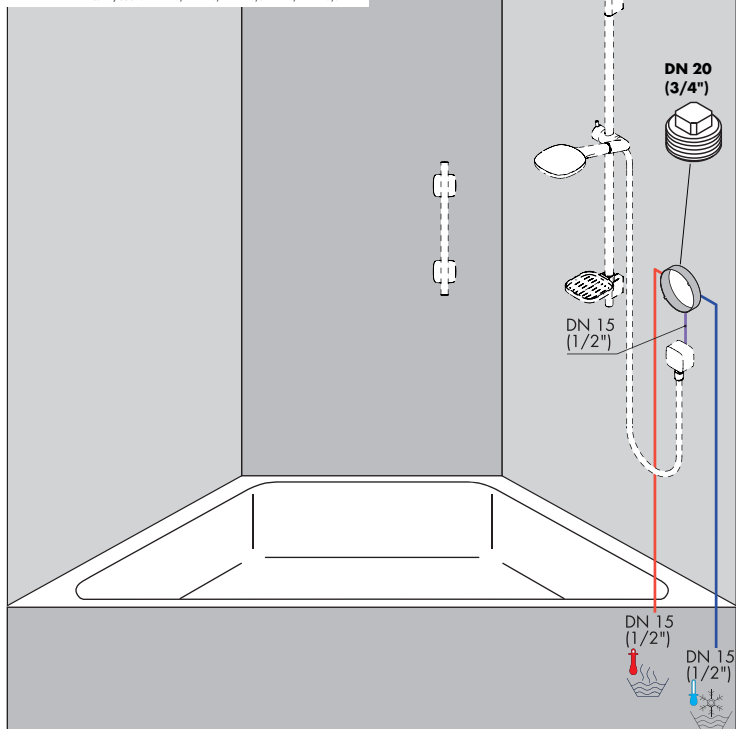
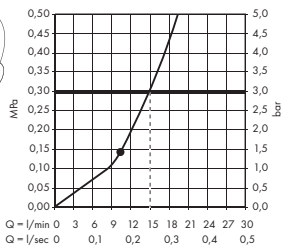
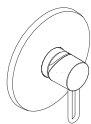

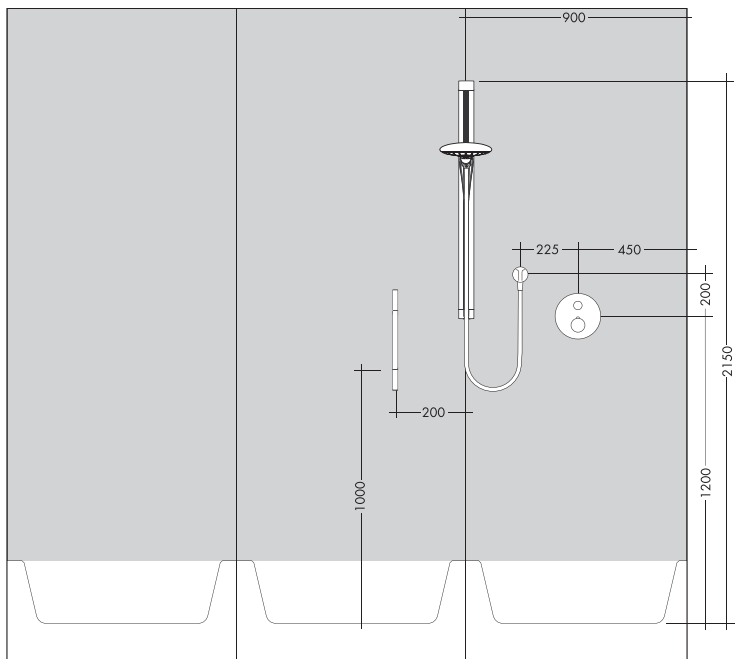
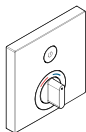
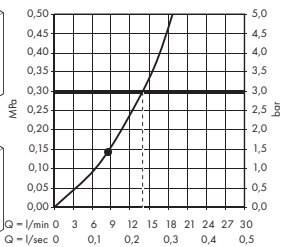
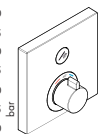
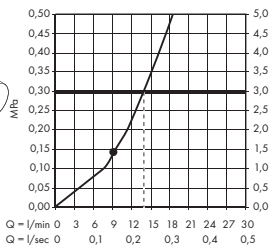

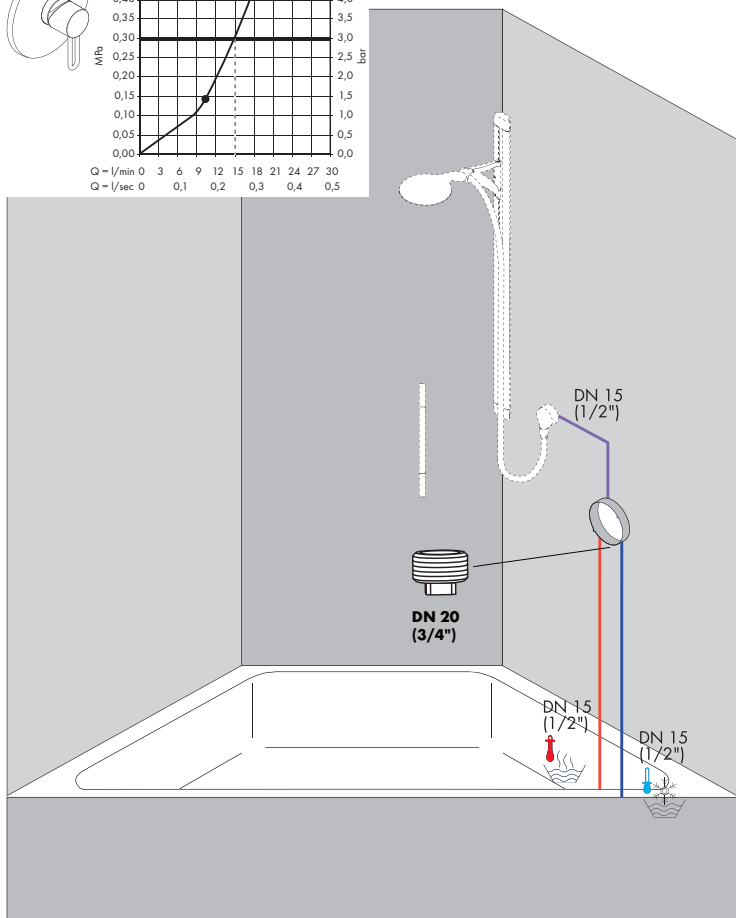
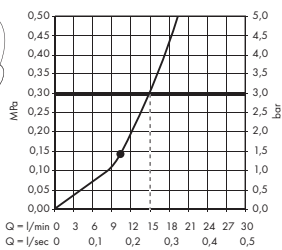
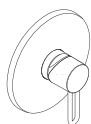

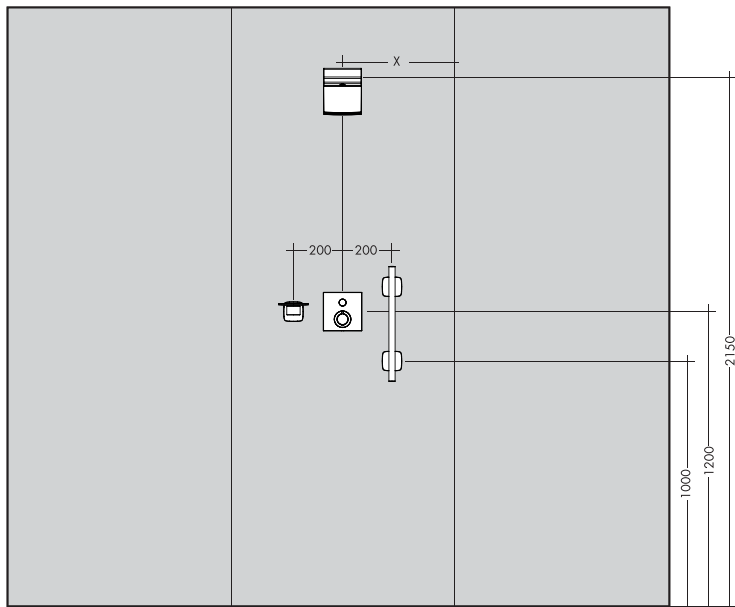
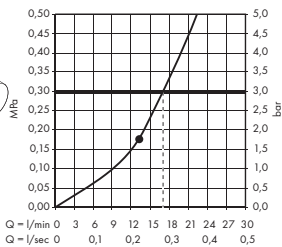
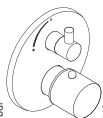
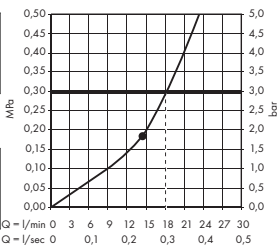
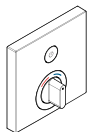
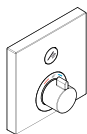

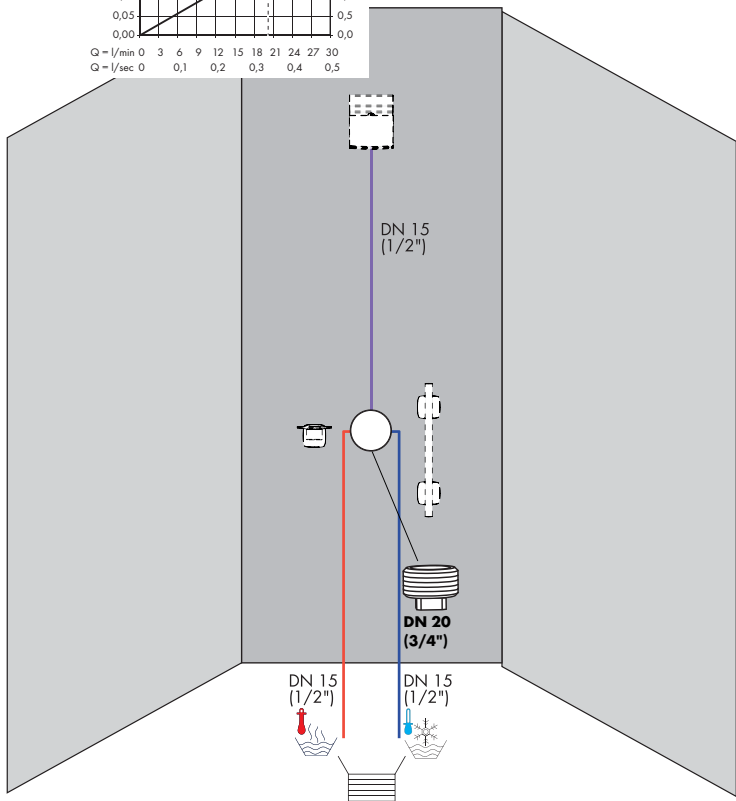
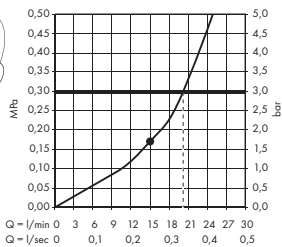
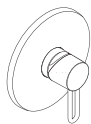

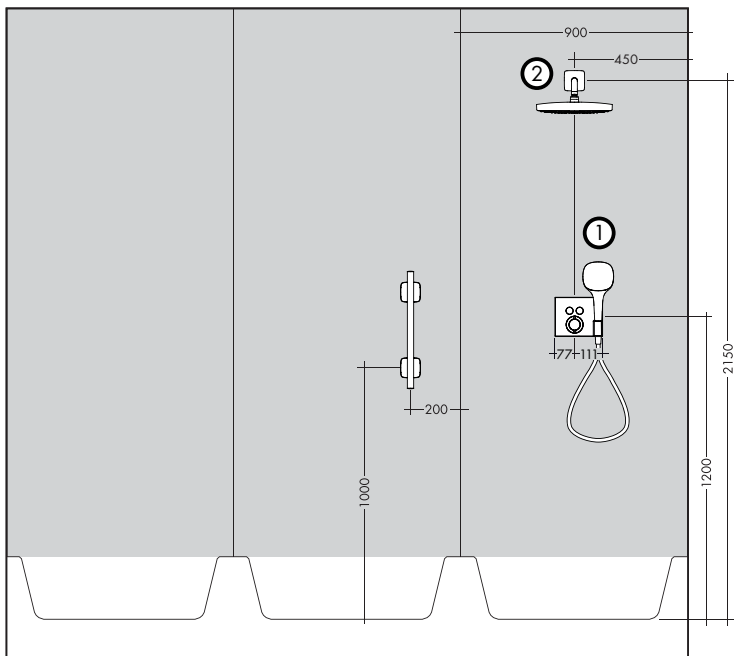
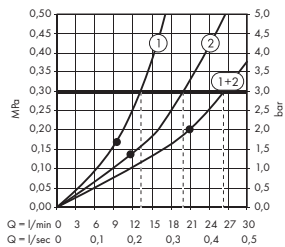
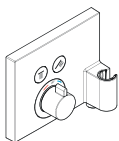

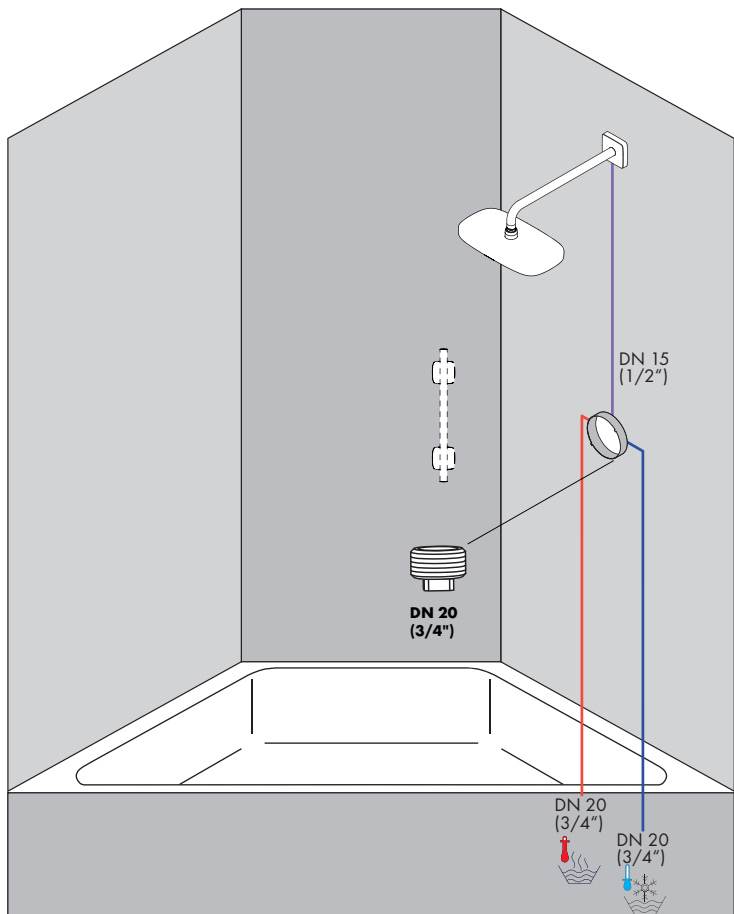

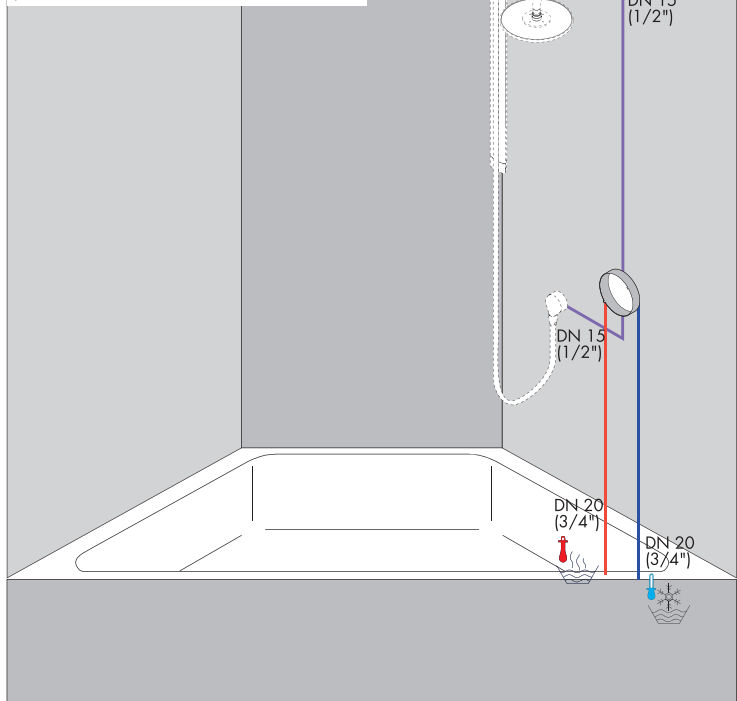
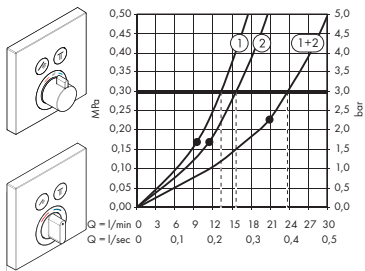

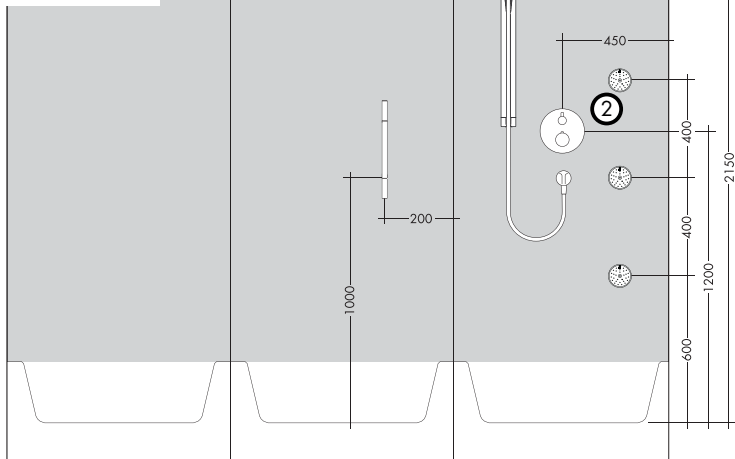
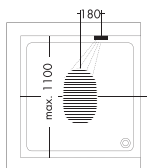
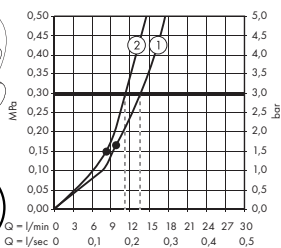
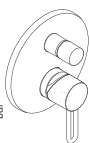
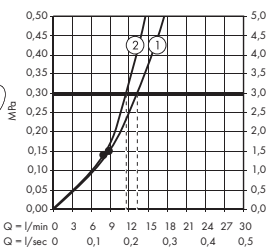
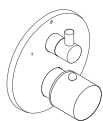

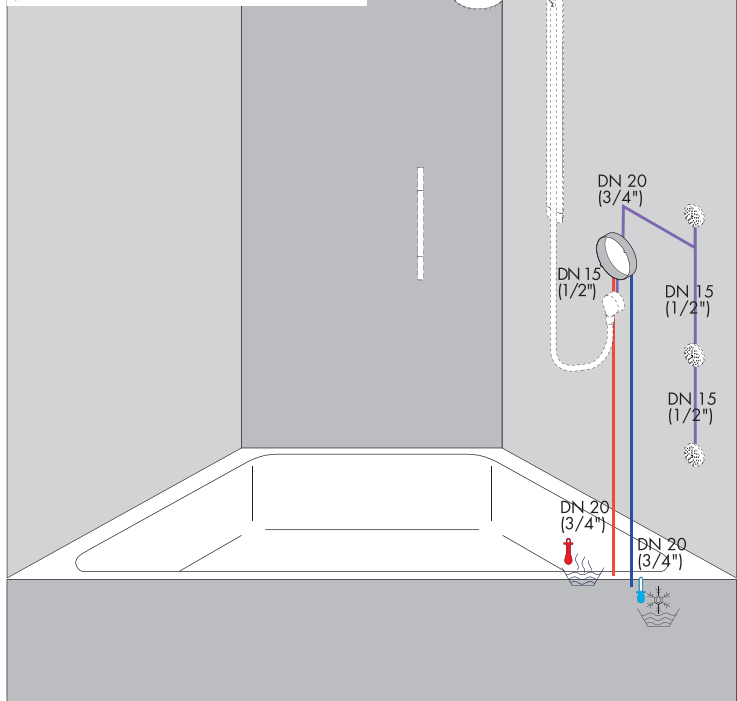
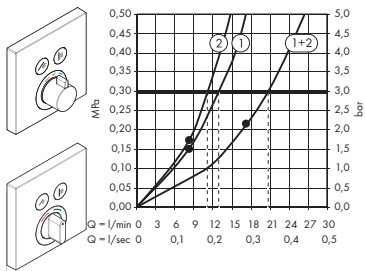

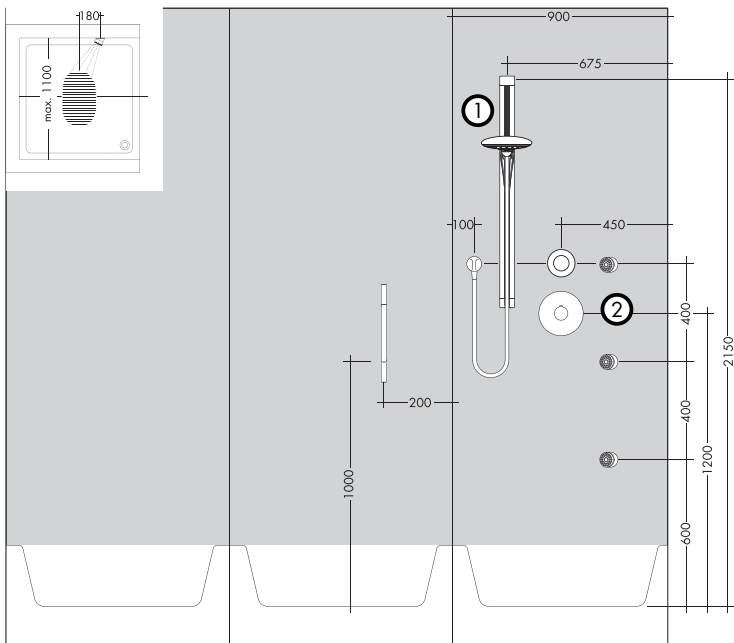
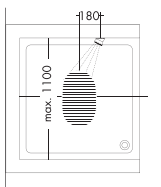
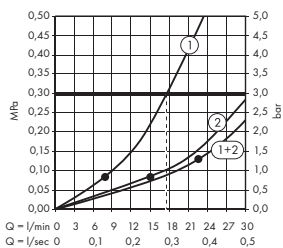

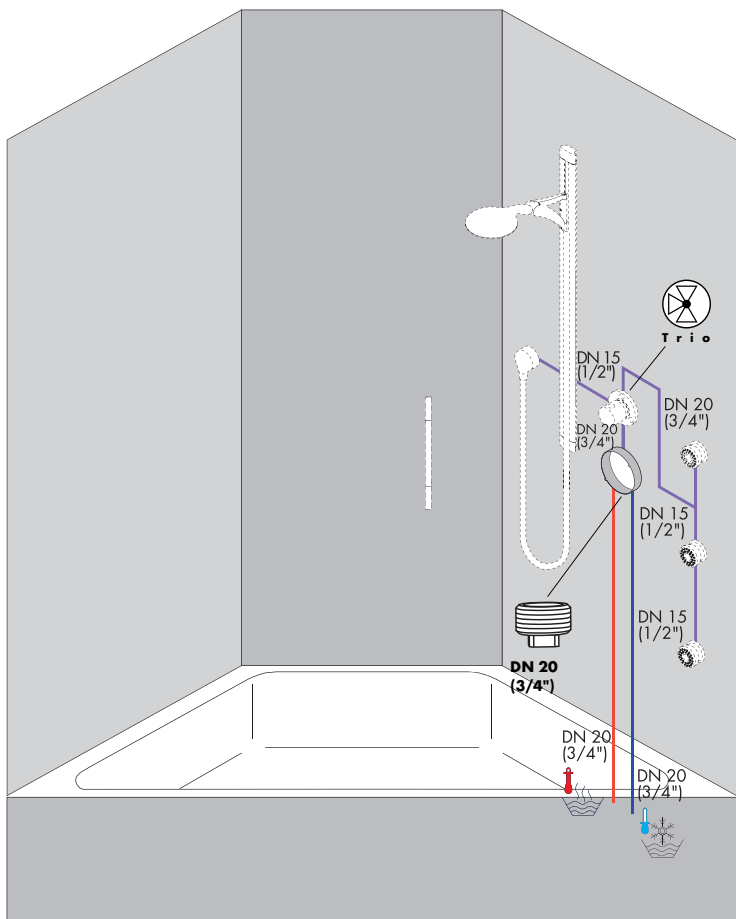

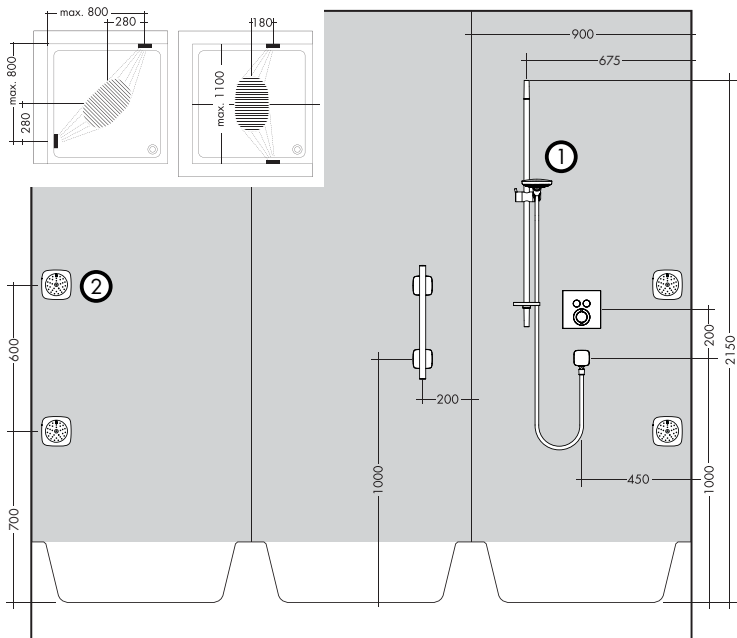
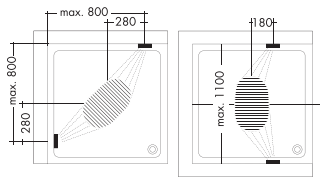
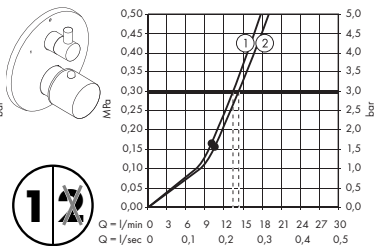
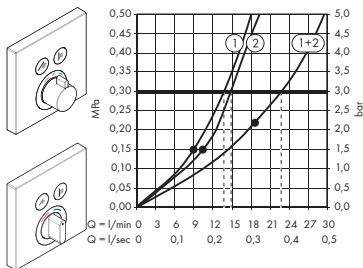

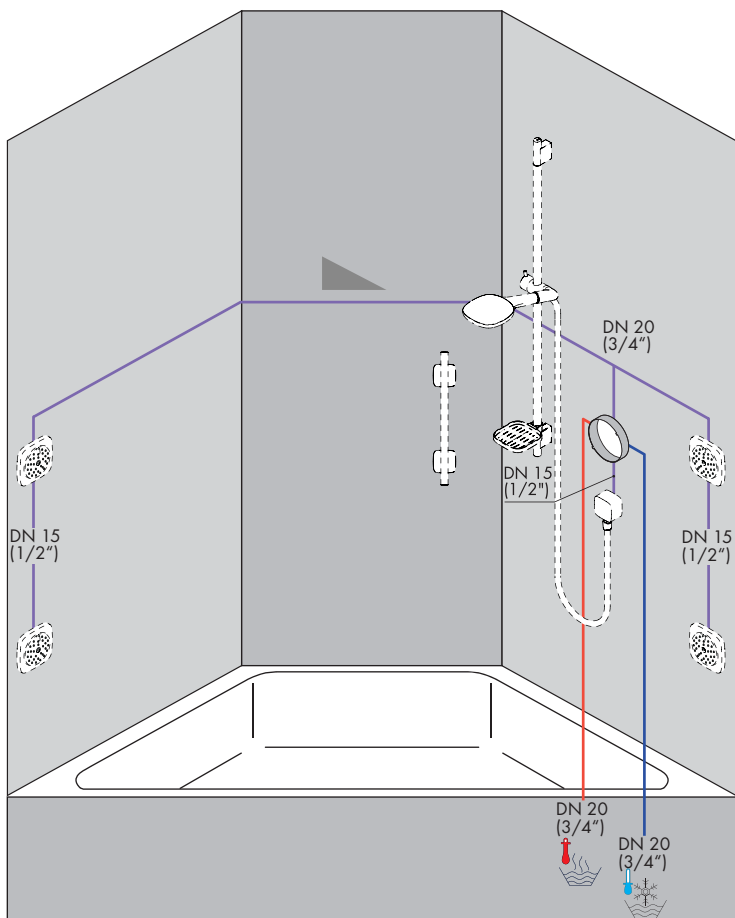

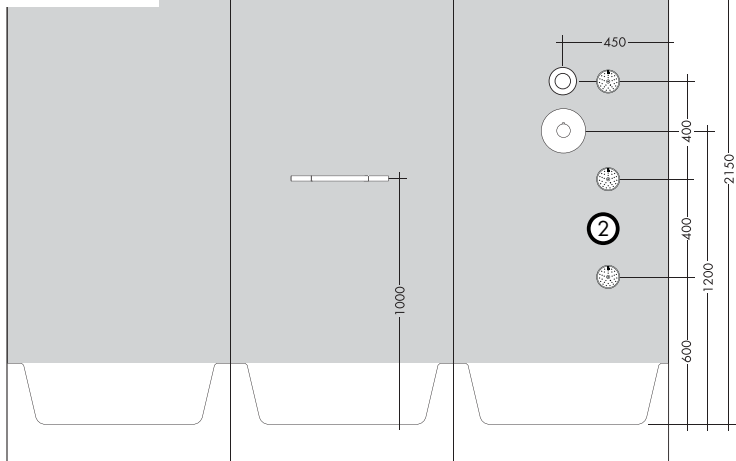
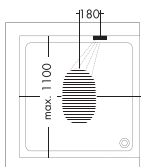
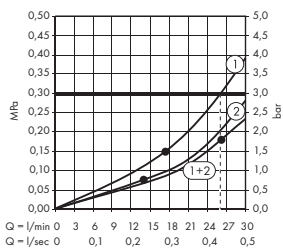

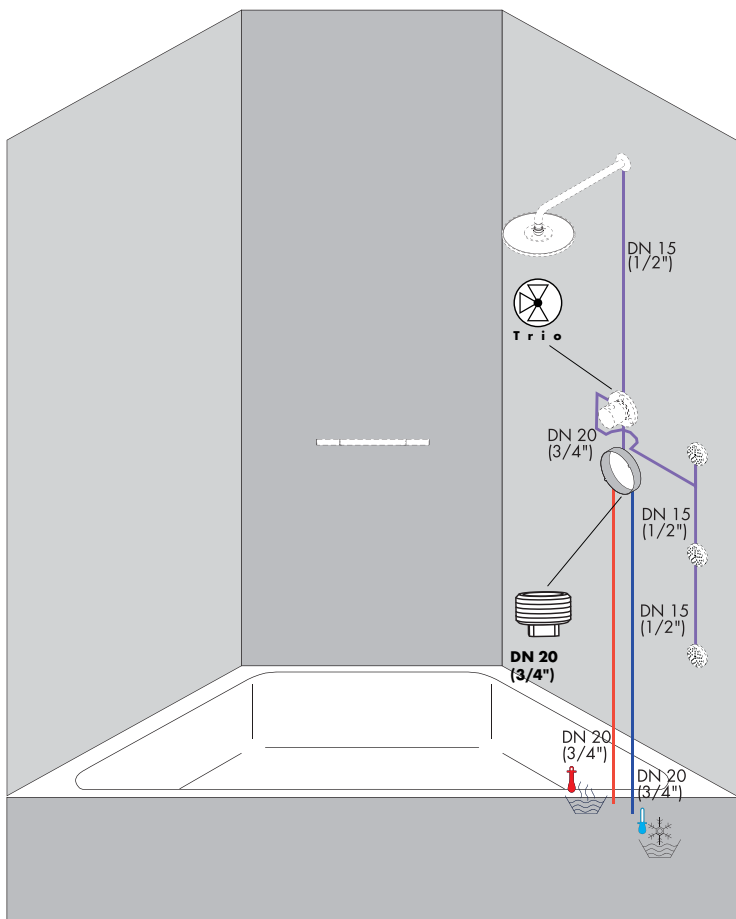

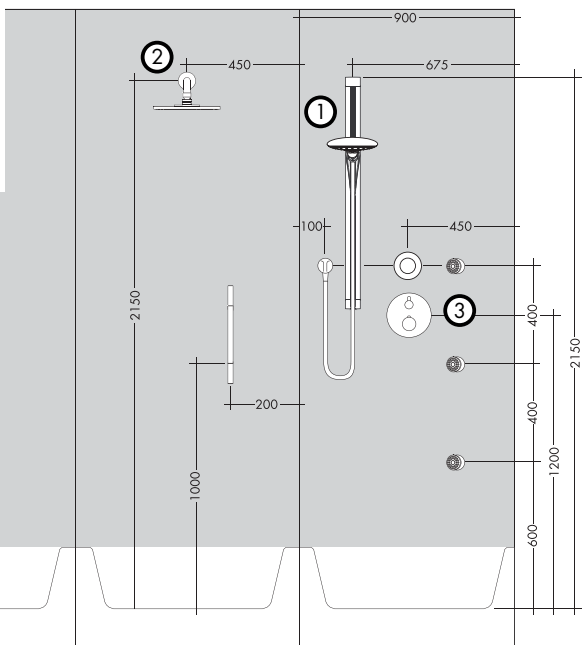
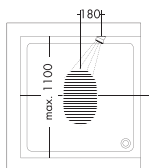
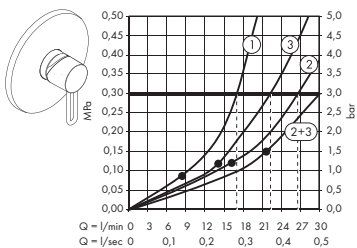
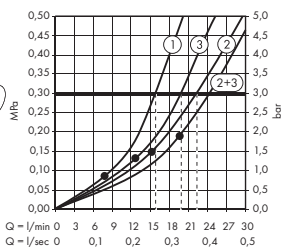

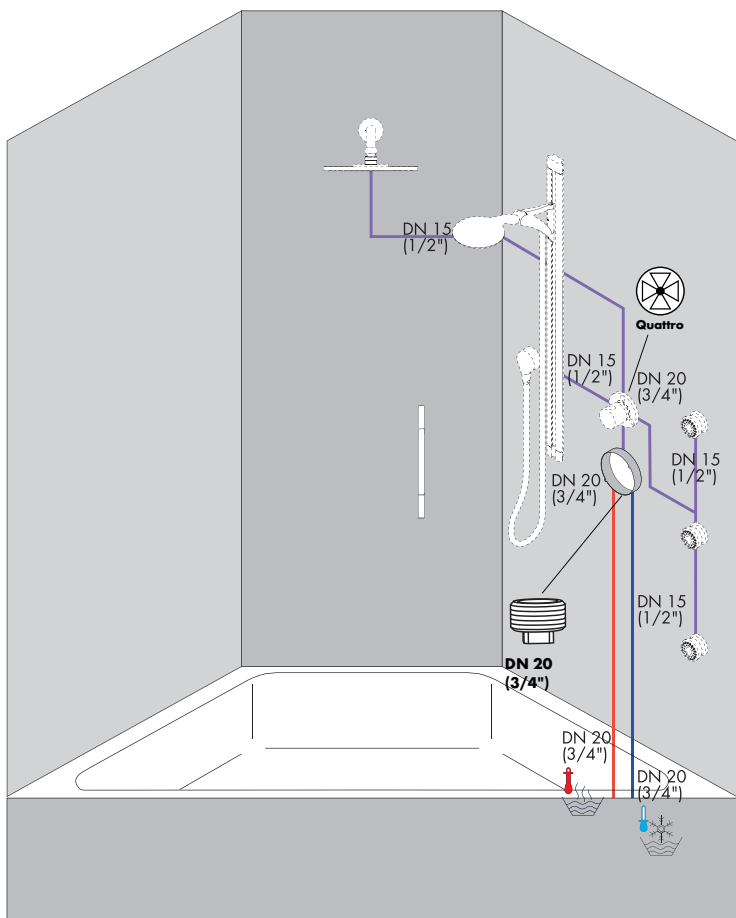

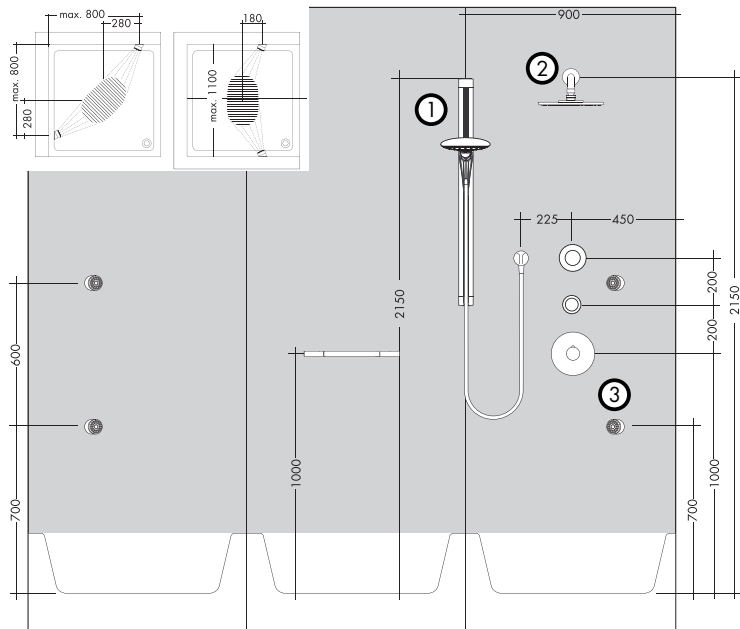
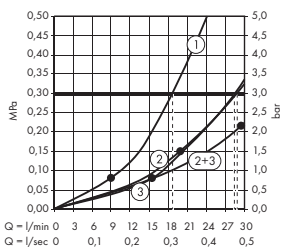

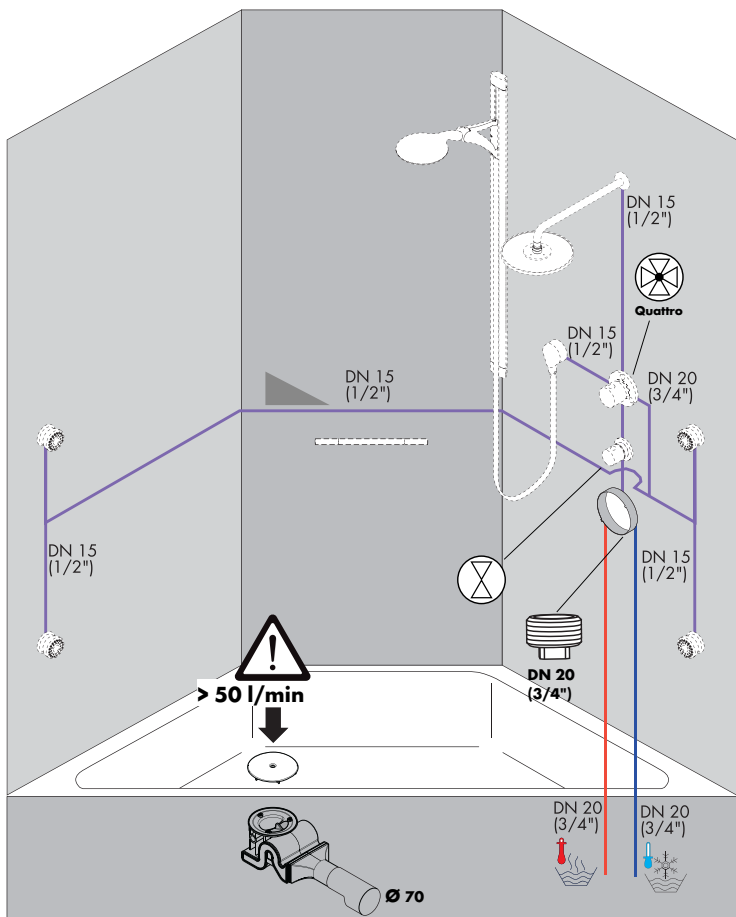

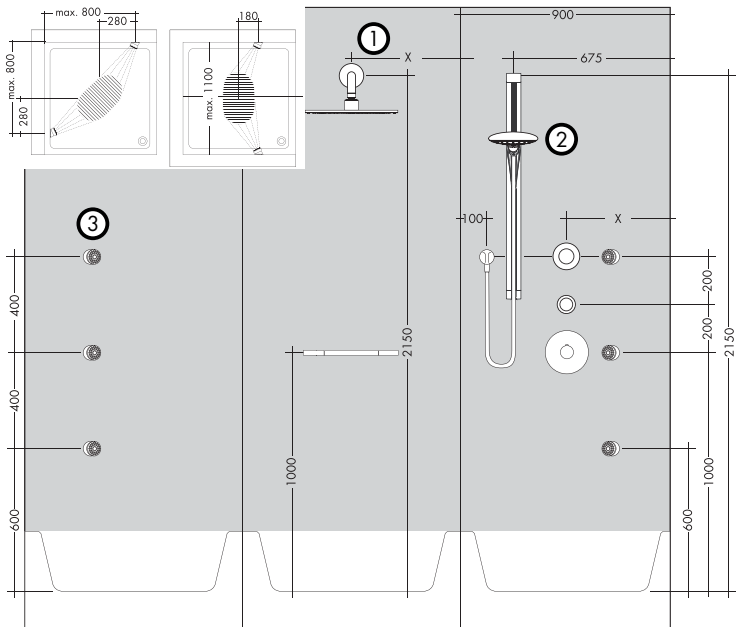
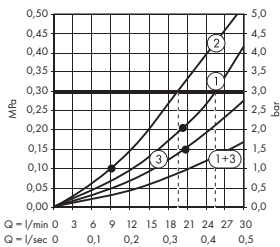

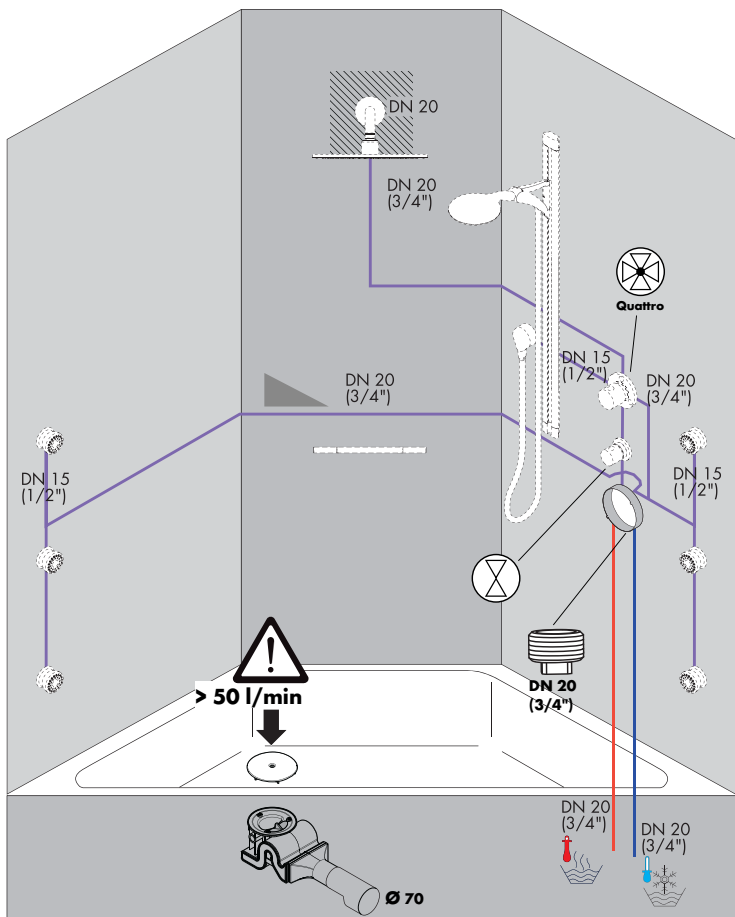

High
Flow

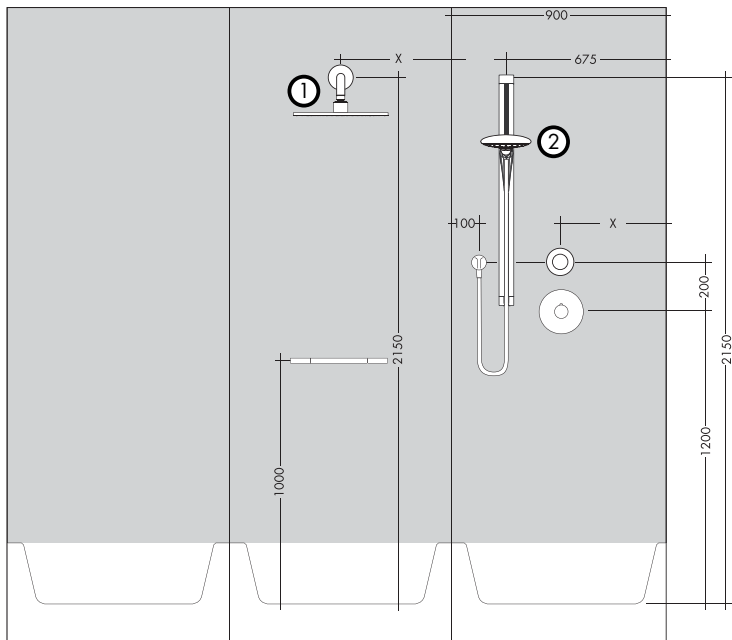
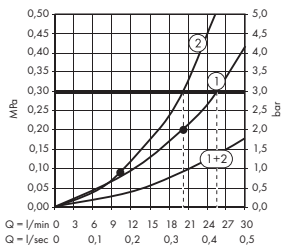

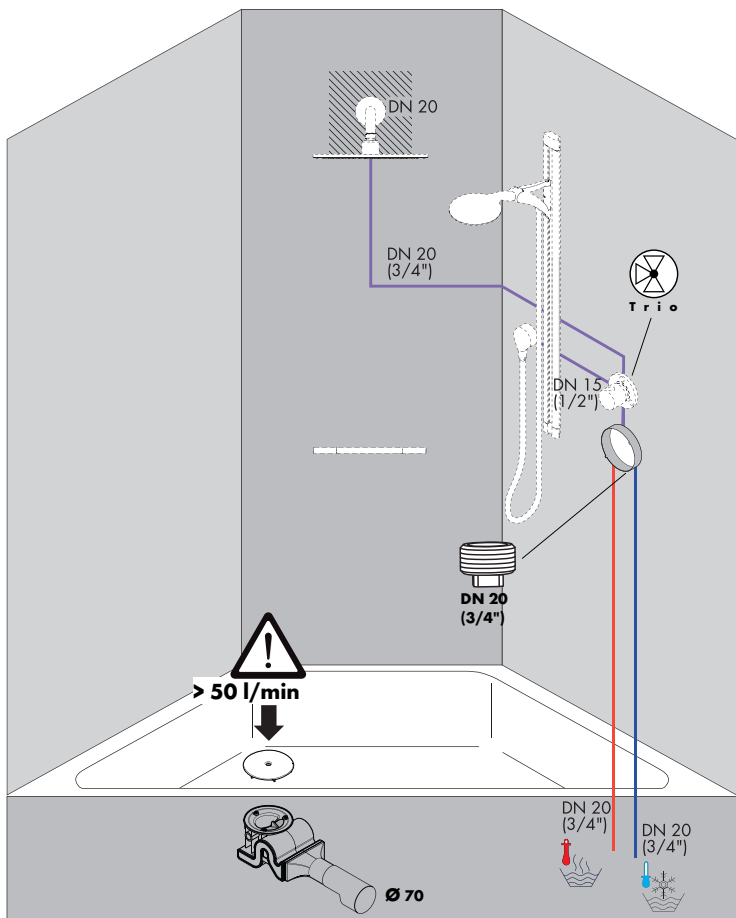

High
Flow

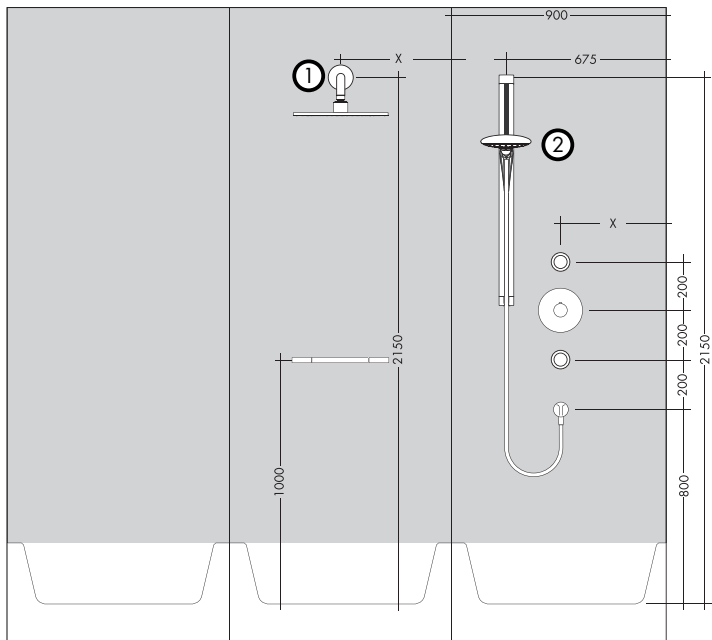
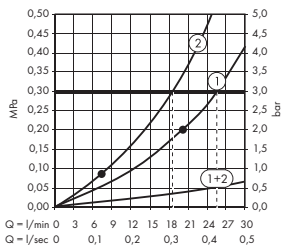

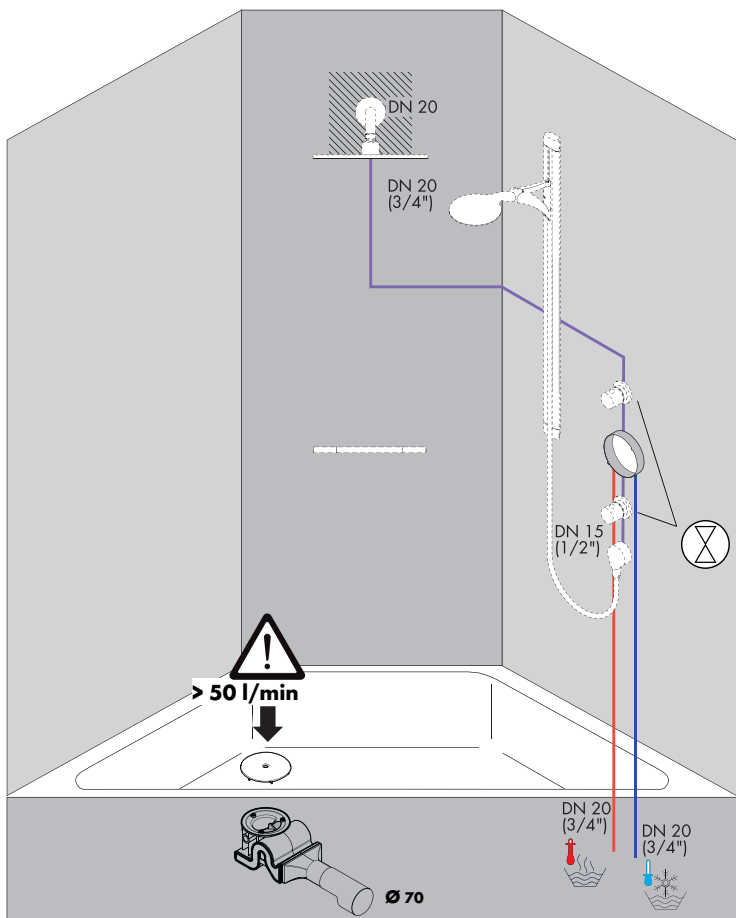

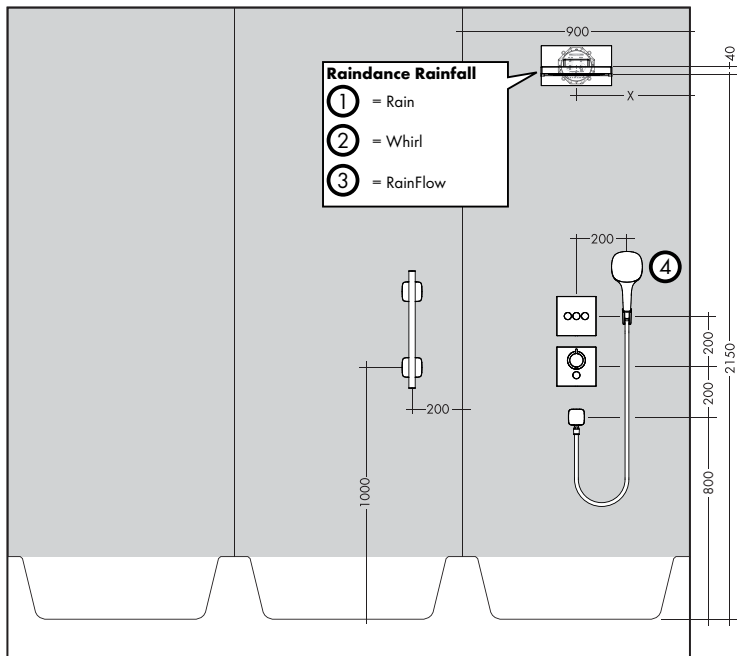
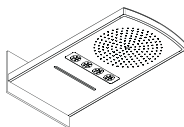
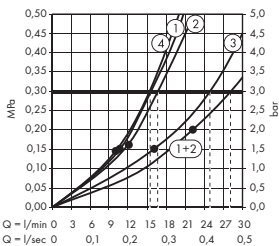
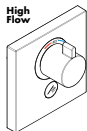
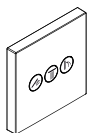

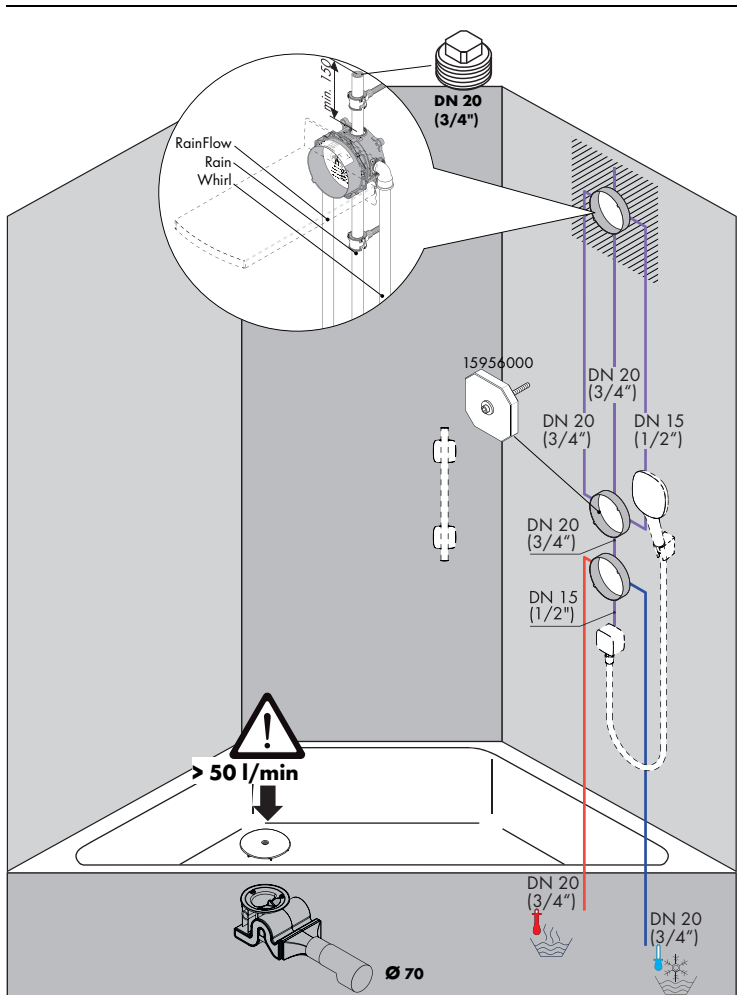

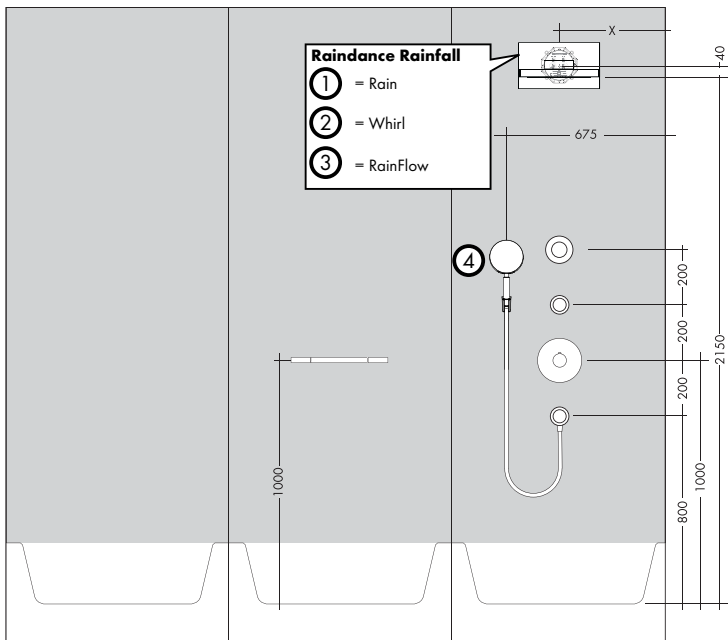
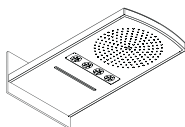
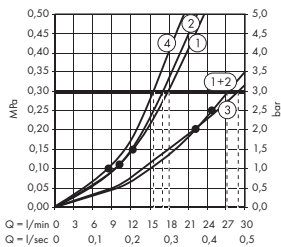

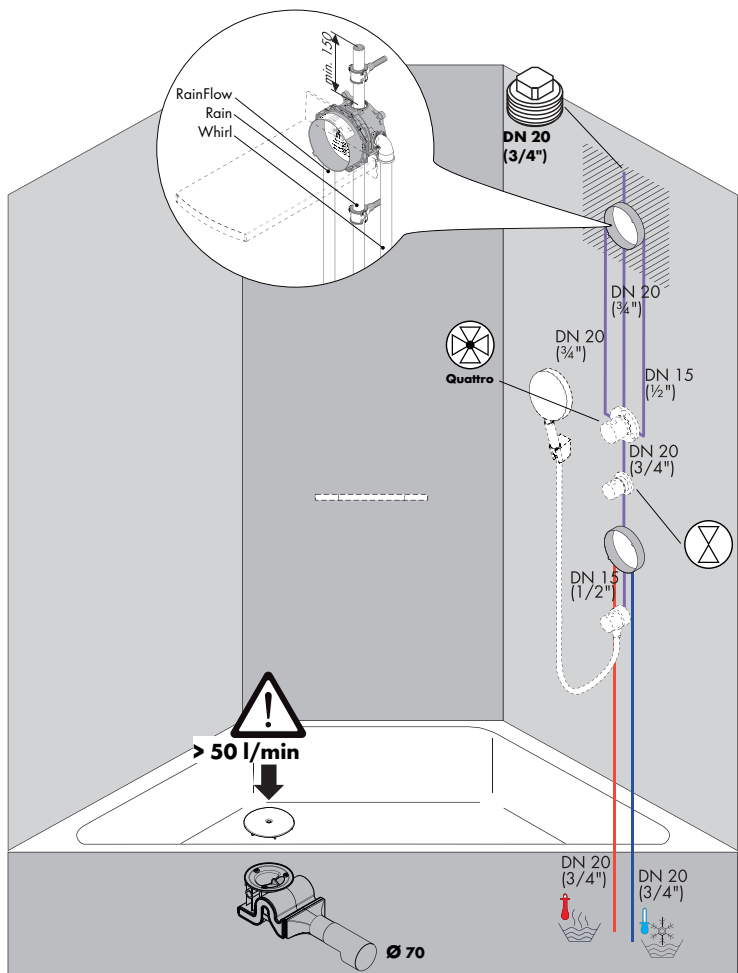

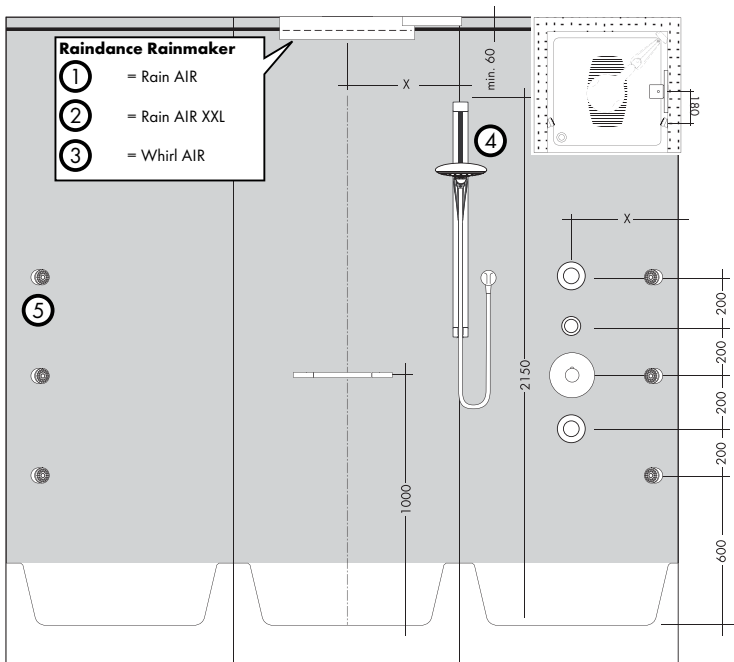
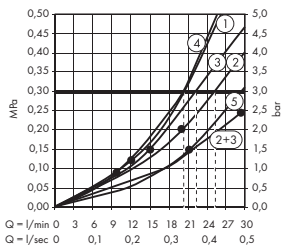

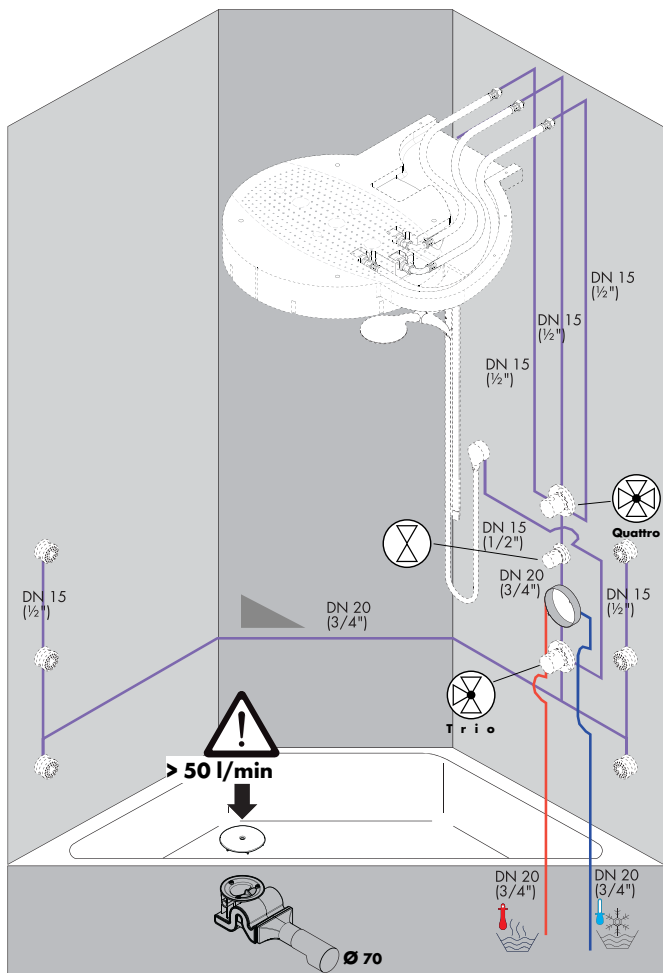

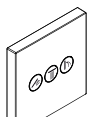

High Flow

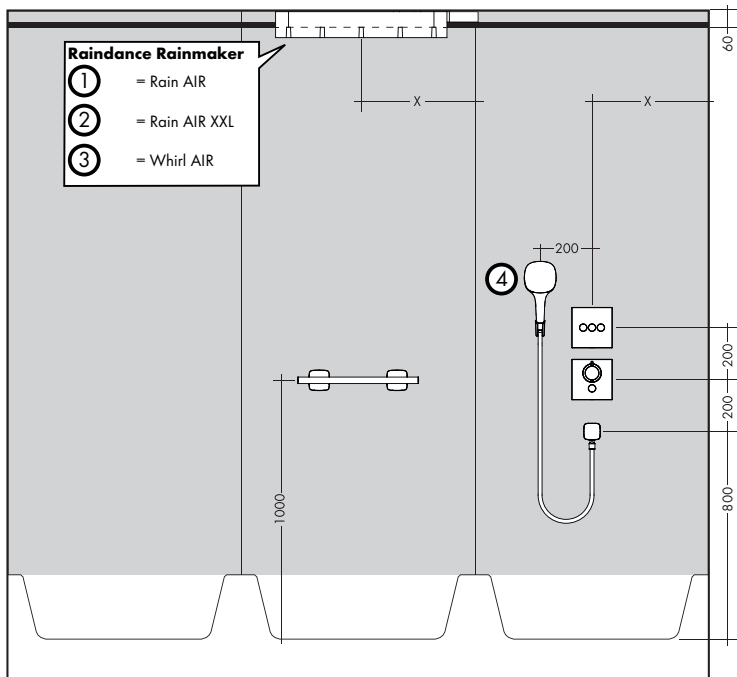
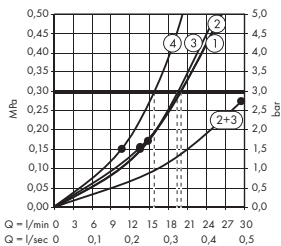
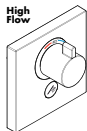

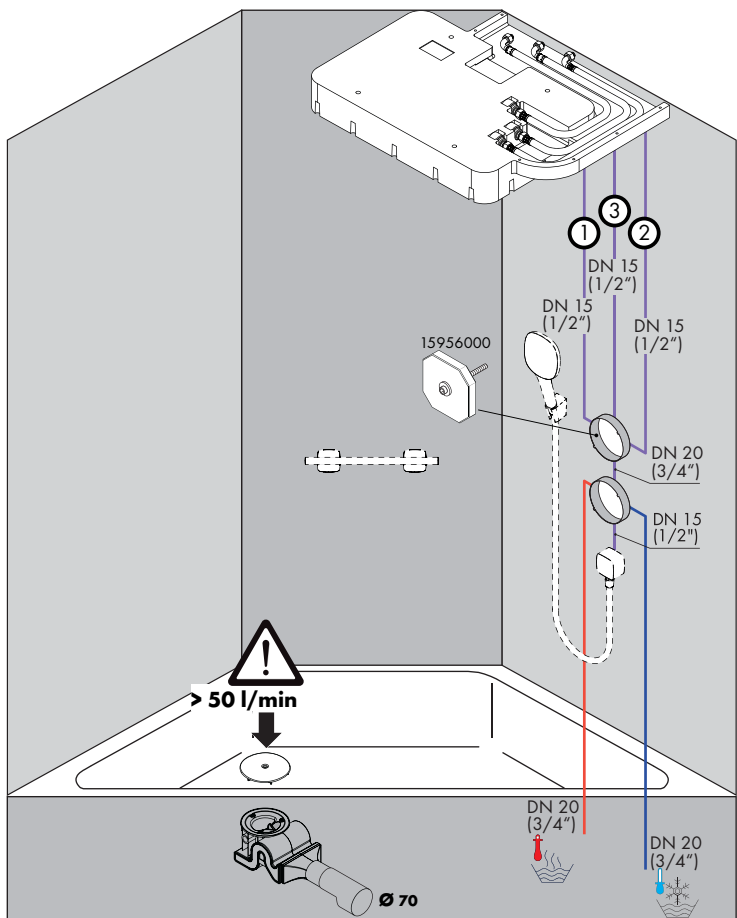

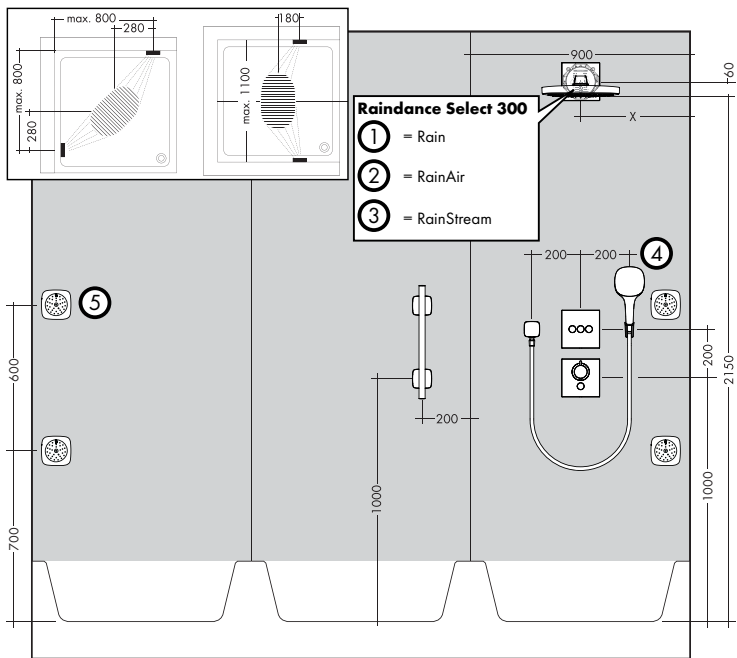
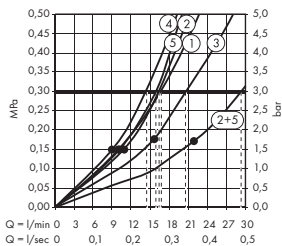
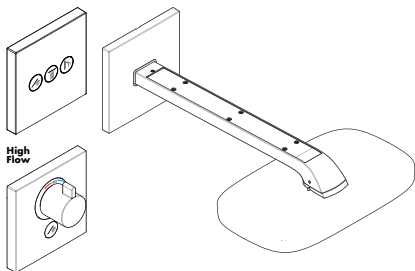

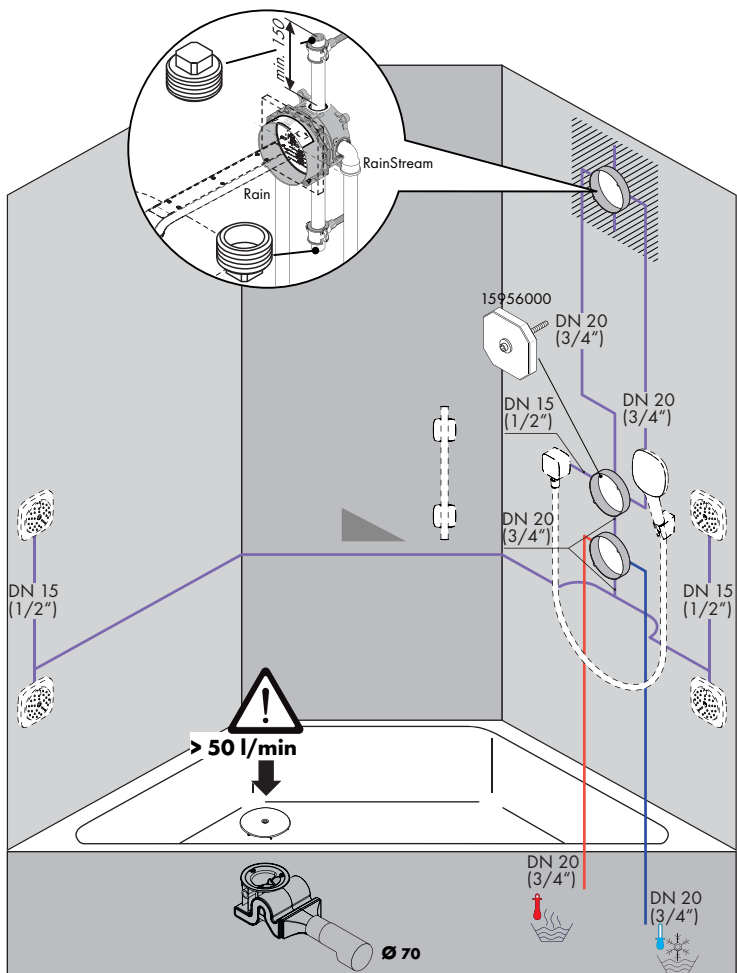

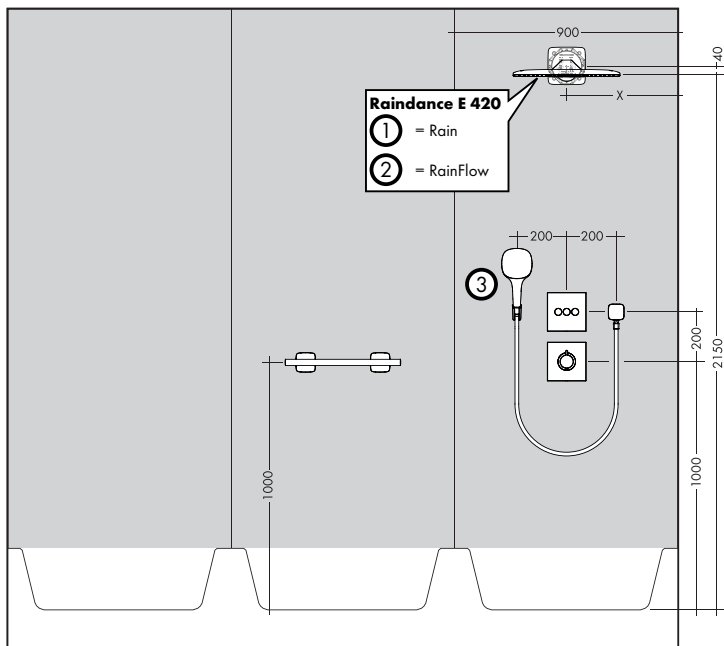
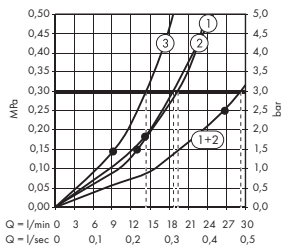
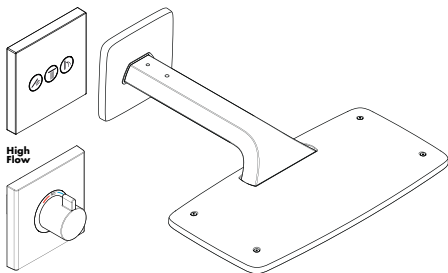

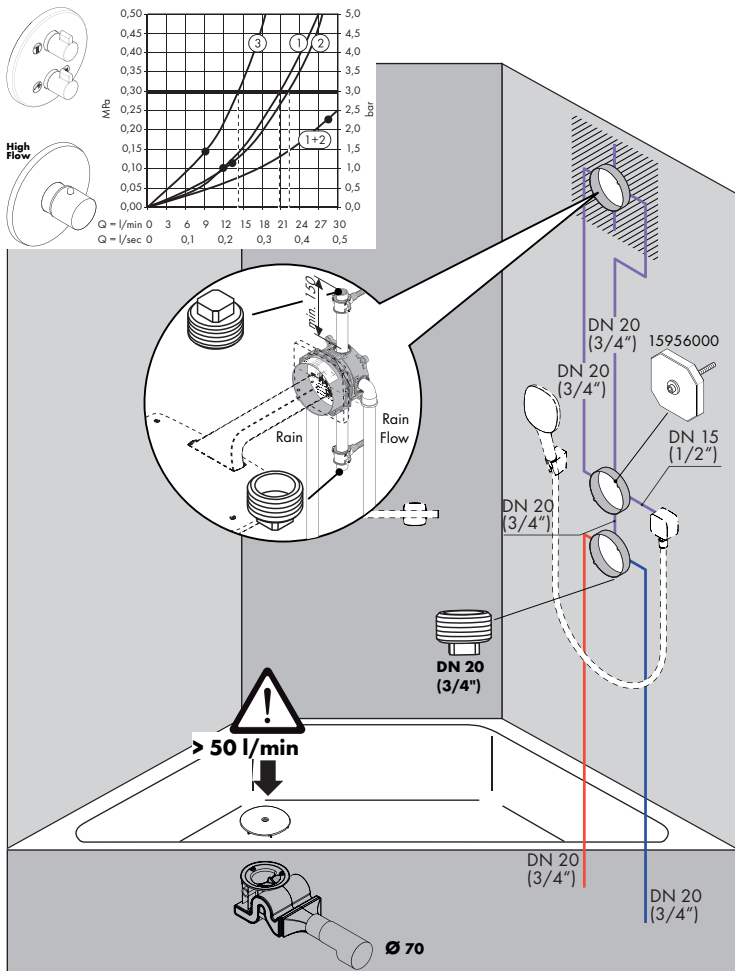

High
Flow

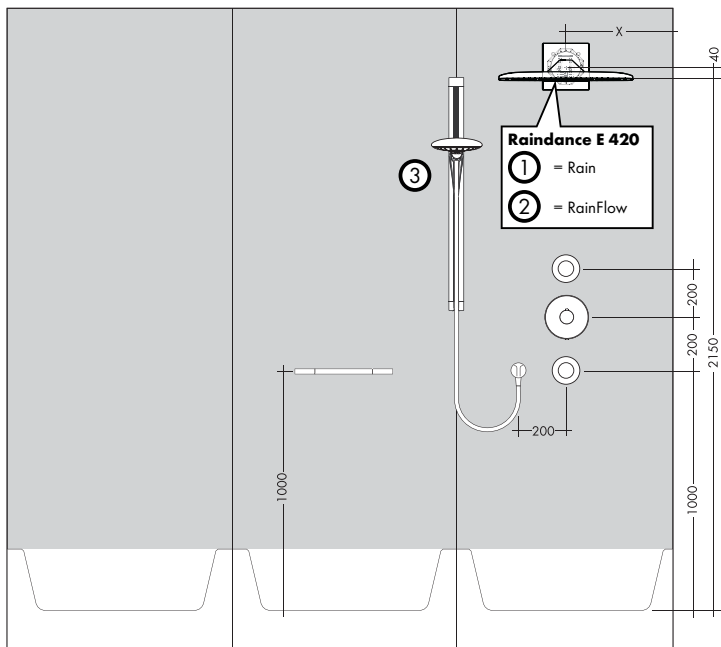
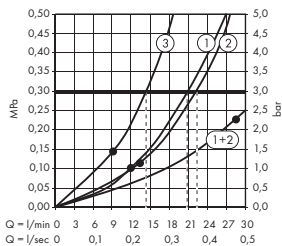
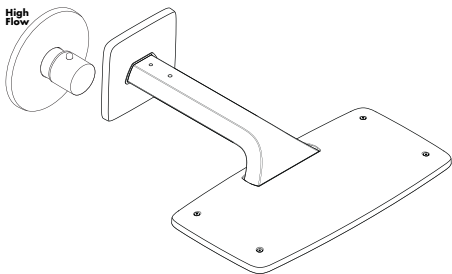

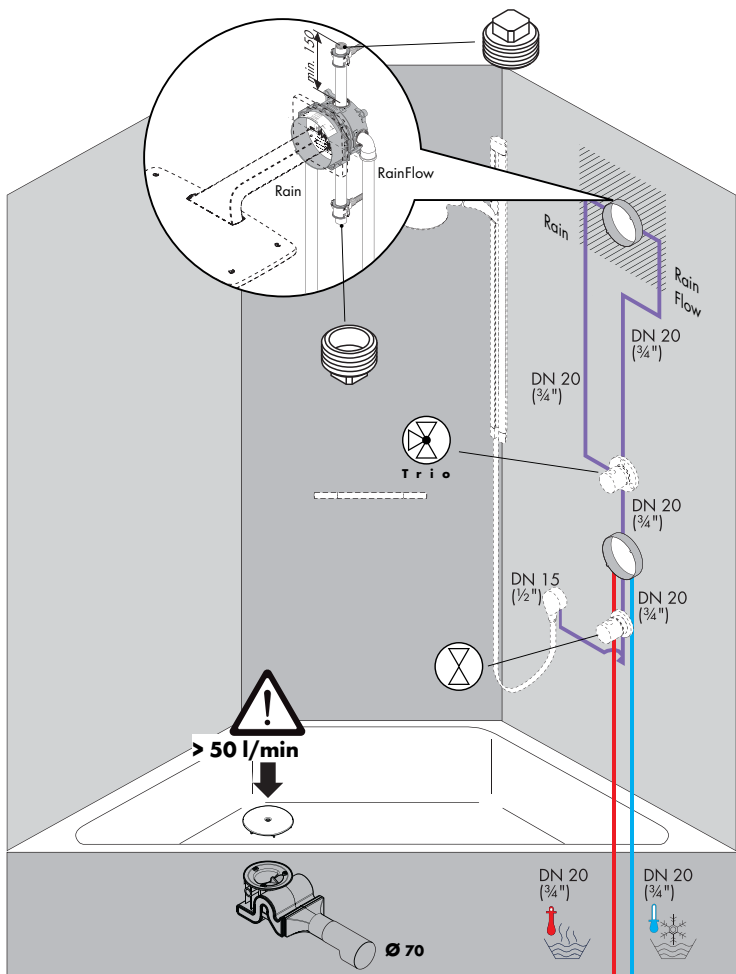

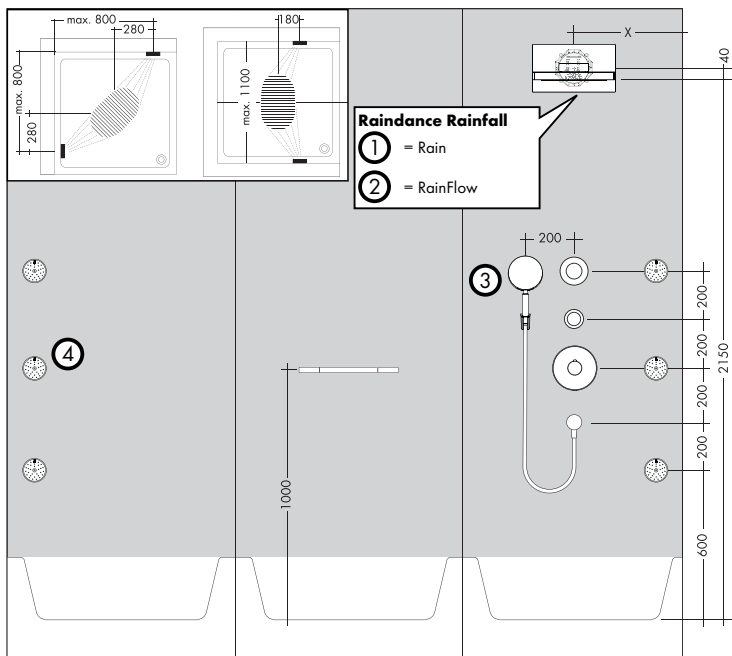
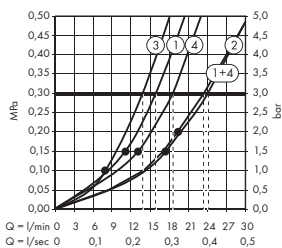
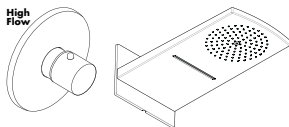

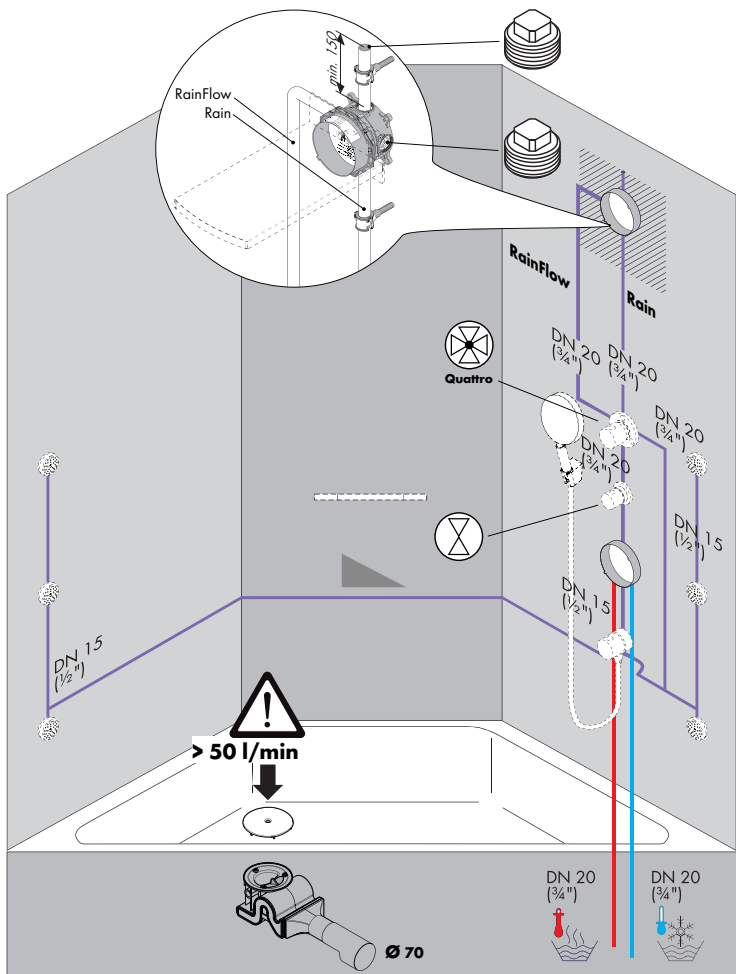

High
Flow

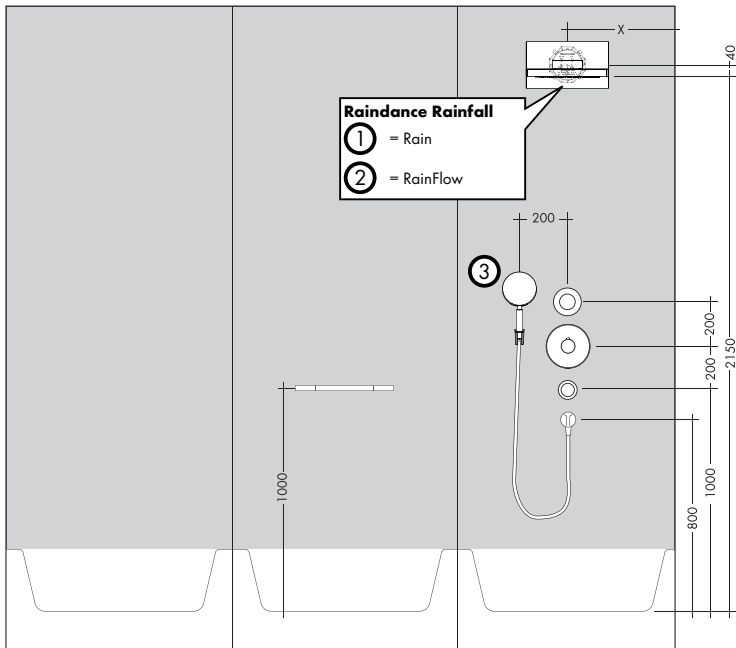
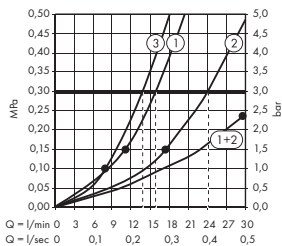
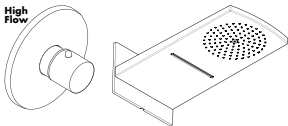

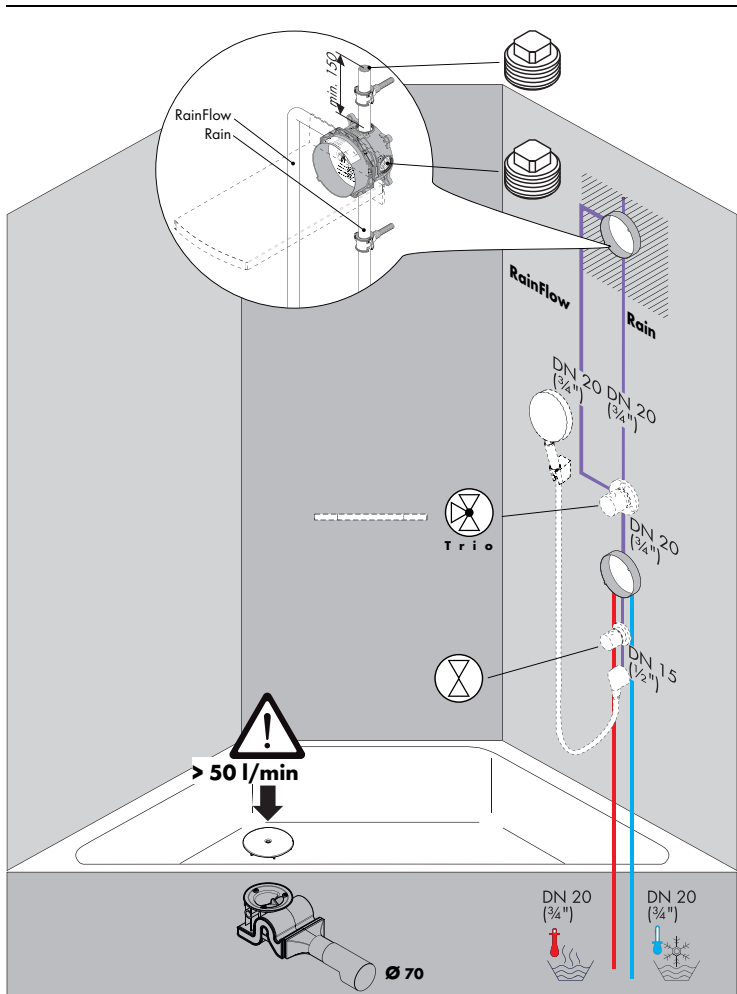

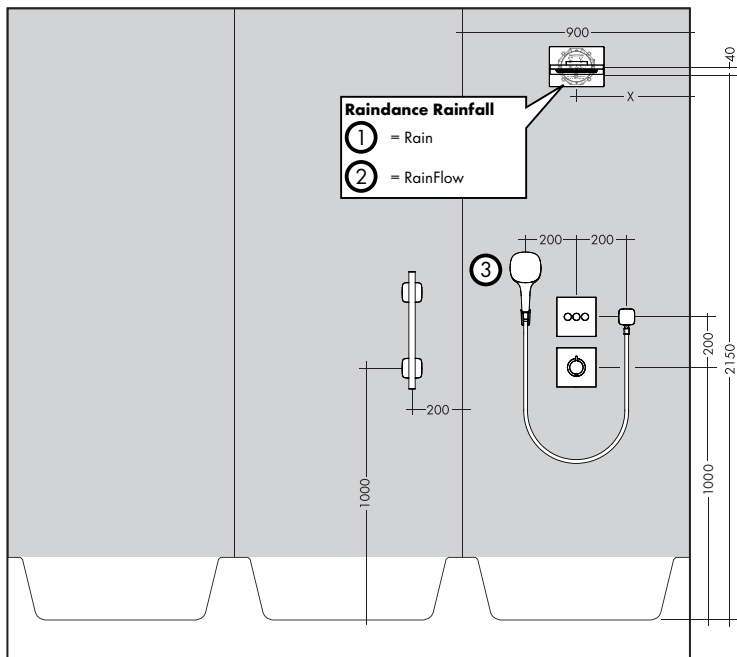
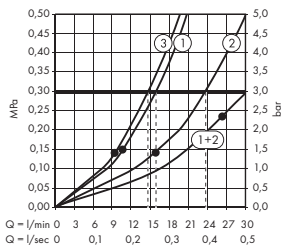
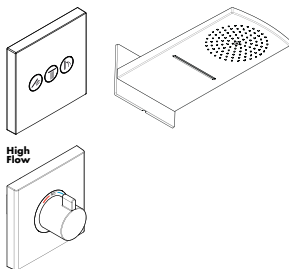

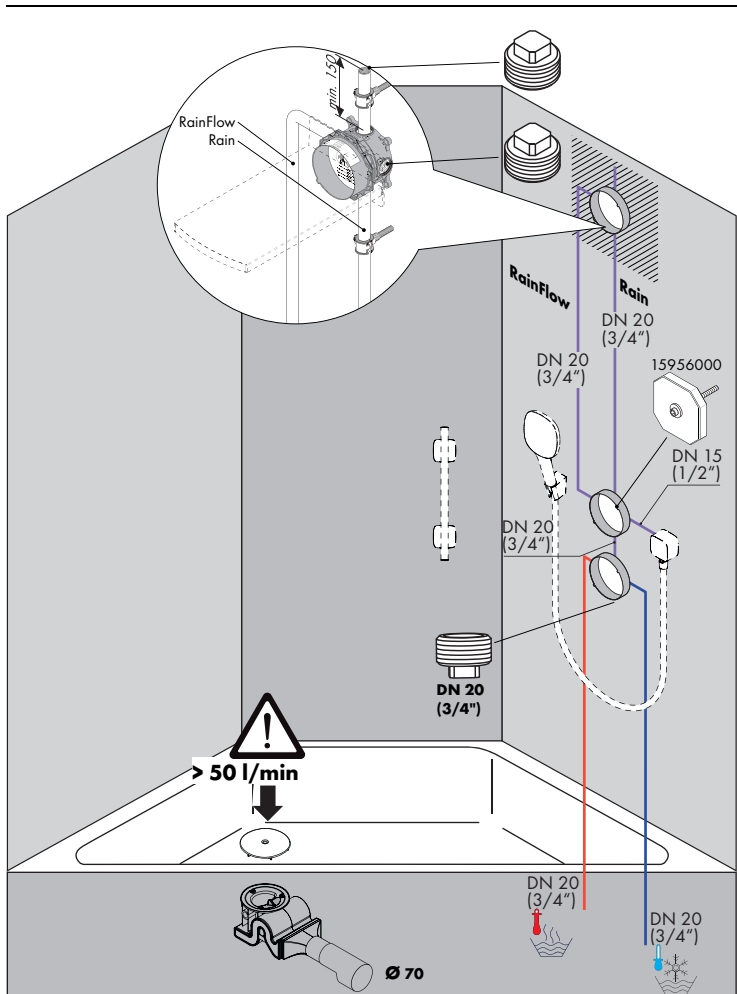

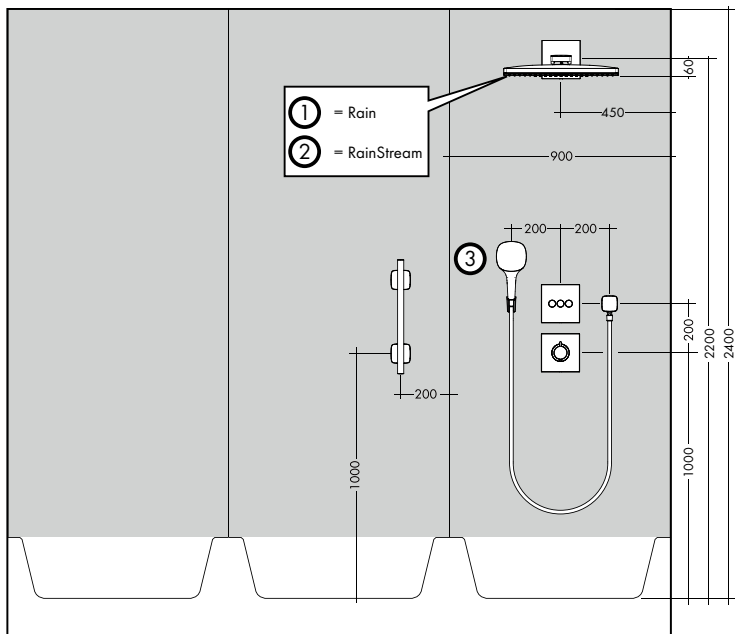
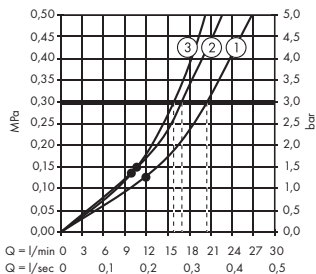
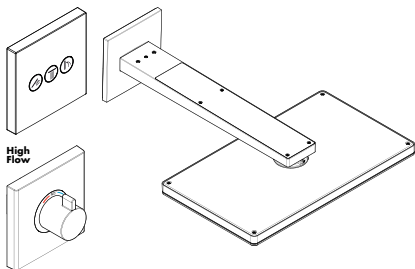

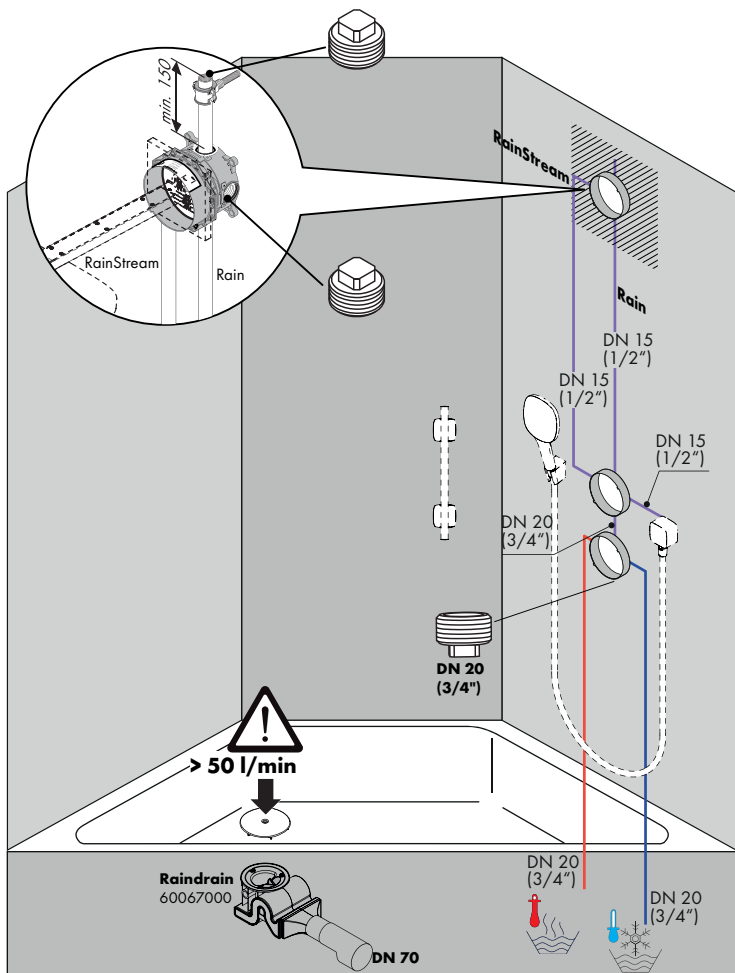

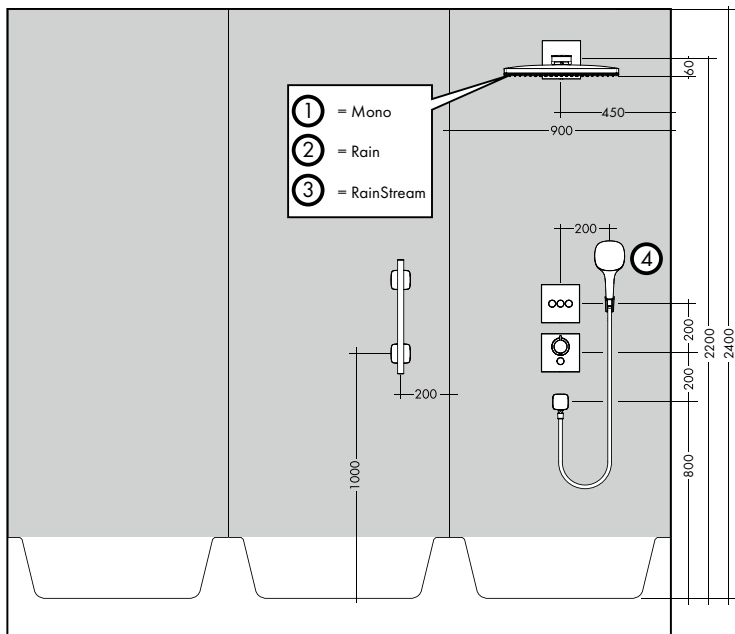
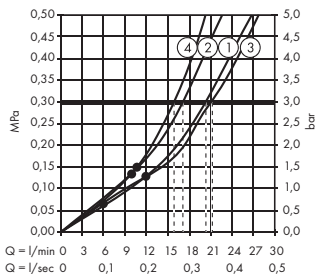
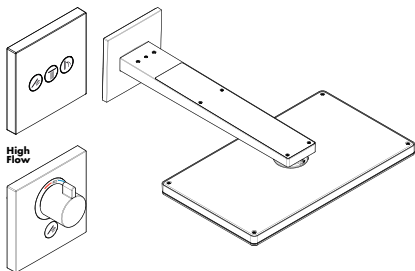

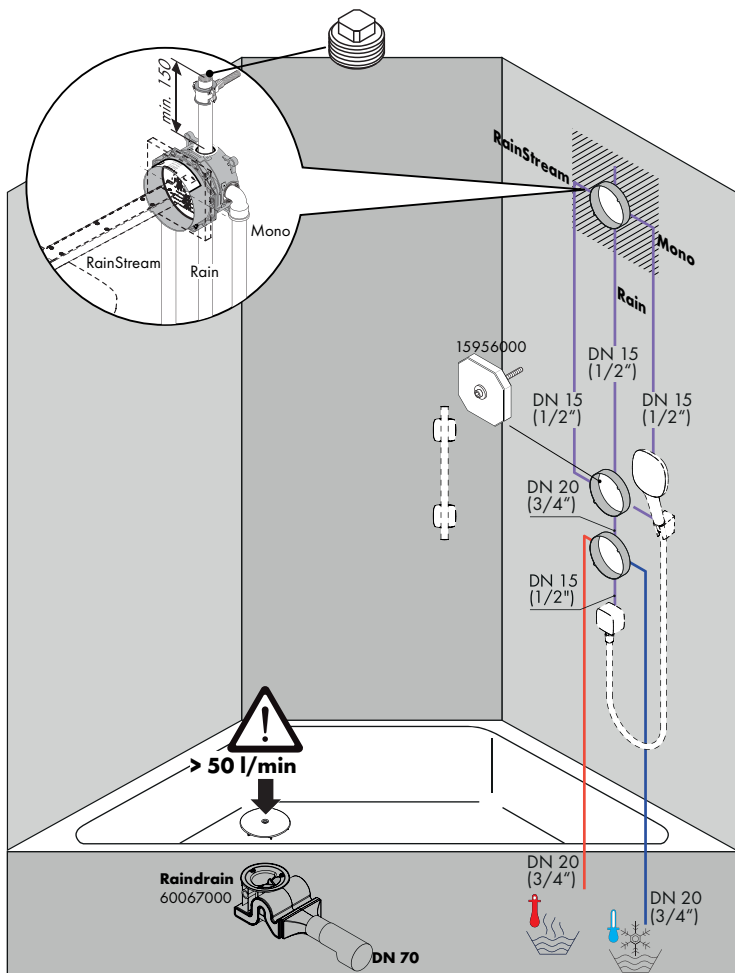

hansgrohe

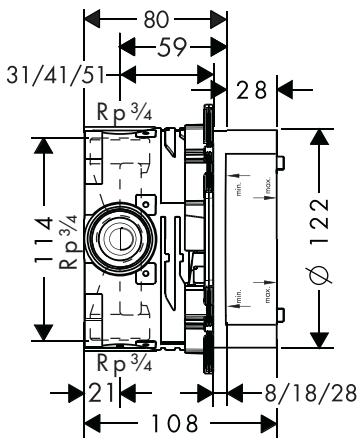
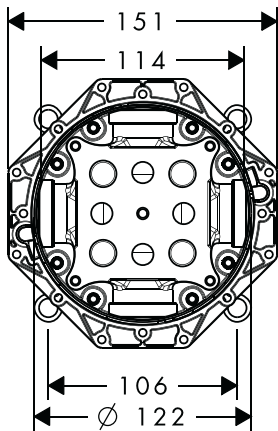
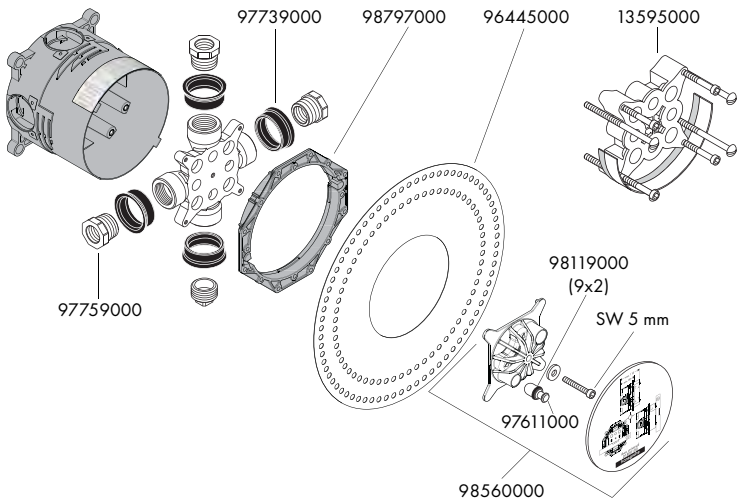

DE Montageanleitung

DK Monteringsvejledning

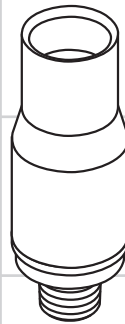

G 1/2
96362000

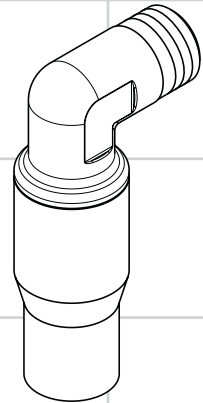

G 3/4
96363000

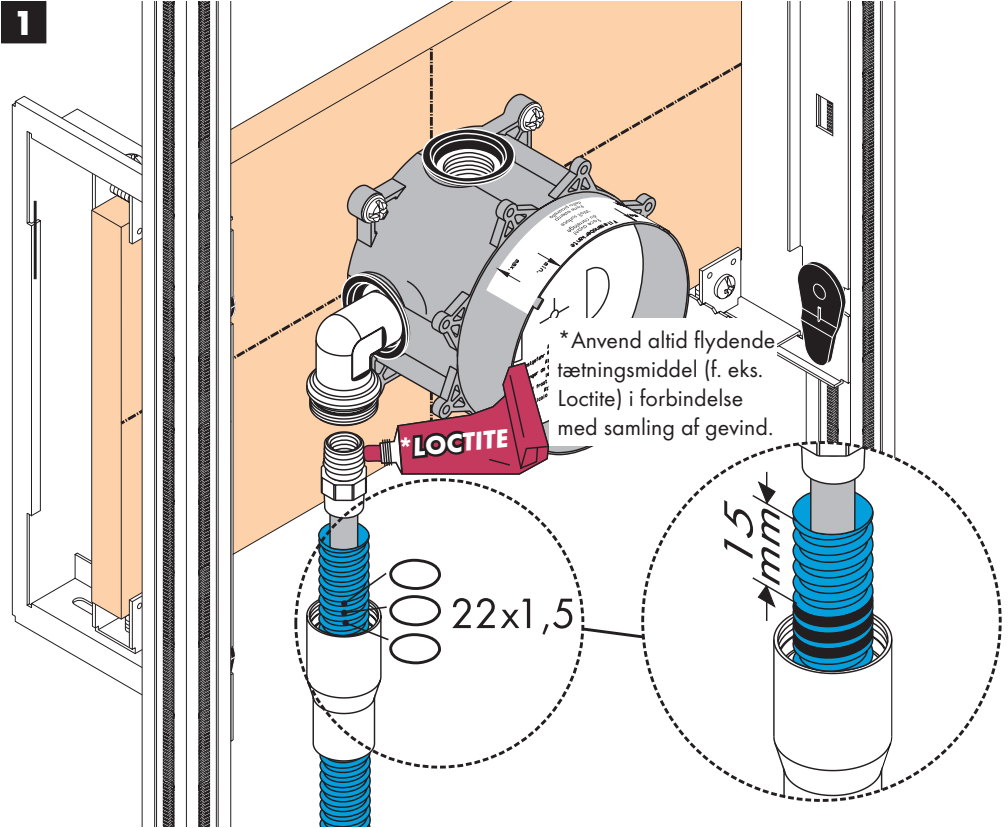

* Die Verbindung der Gewinde muss mit flüssigem Dichtungsmittel (z. B. Loctite) abgedichtet sein.

DE Die in den Ländern jeweils gültigen Installationsrichtlinien sind einzuhalten.

DK Installationsbestemmelserne, der gælder i det enkelte land, skal overholdes.

**Prüfzeichen
Godkendelse**



GODKENDT
TIL DRILKEVAND



96362000

03/00004

1420

96363000

2

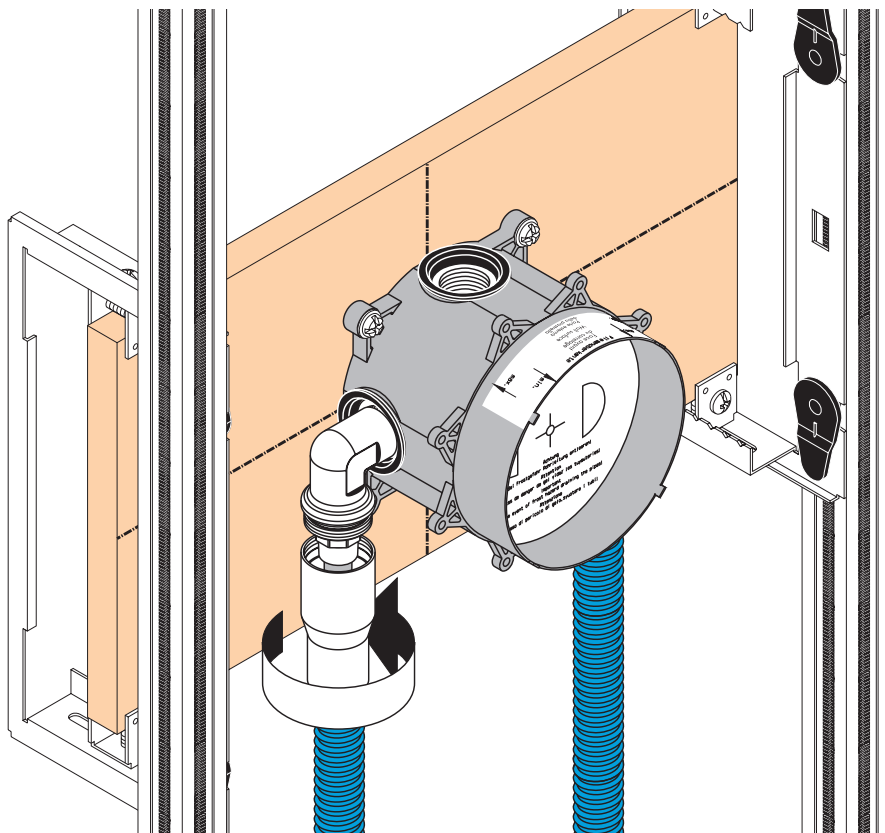

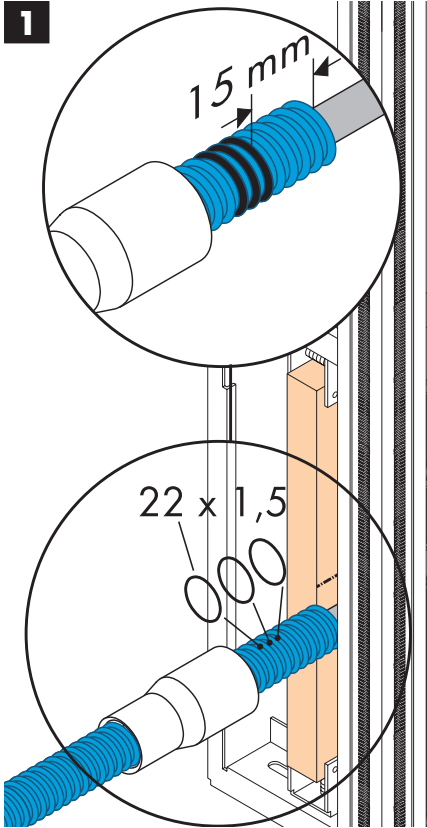

* Anvend altid flydende tætningsmiddel (f. eks. Loctite) i forbindelse med samling af gevind.

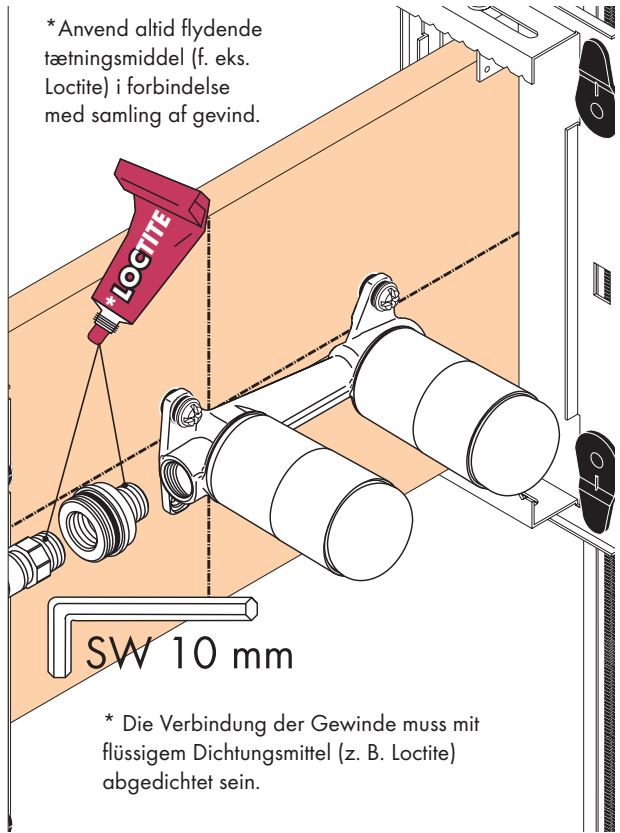

* Die Verbindung der Gewinde muss mit flüssigem Dichtungsmittel (z. B. Loctite) abgedichtet sein.

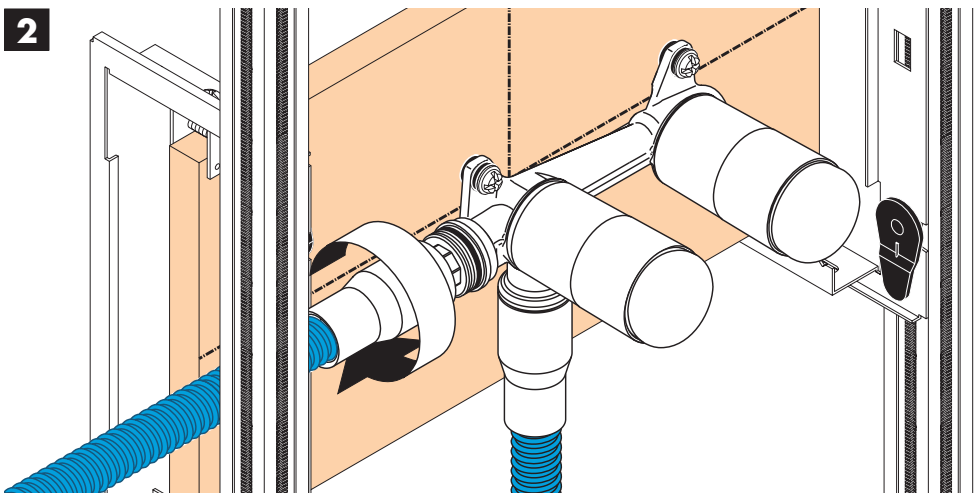

hansgrohe