

Approval body for construction products
and types of construction

Bautechnisches Prüfamt

An institution established by the Federal and
Laender Governments



European Technical Assessment

ETA-07/0121
of 13 December 2018

English translation prepared by DIBt - Original version in German language

General Part

Technical Assessment Body issuing the
European Technical Assessment:

Deutsches Institut für Bautechnik

Trade name of the construction product

fischer frame fixing SXR/ SXRL

Product family
to which the construction product belongs

Plastic anchor for multiple use in concrete and masonry
for non-structural applications

Manufacturer

fischerwerke GmbH & Co. KG
Klaus-Fischer-Straße 1
72178 Waldachtal
DEUTSCHLAND

Manufacturing plant

fischerwerke

This European Technical Assessment
contains

39 pages including 3 annexes which form an integral part
of this assessment

This European Technical Assessment is
issued in accordance with Regulation (EU)
No 305/2011, on the basis of

EAD 330284-00-0604

This version replaces

ETA-07/0121 issued on 30 March 2017

The European Technical Assessment is issued by the Technical Assessment Body in its official language. Translations of this European Technical Assessment in other languages shall fully correspond to the original issued document and shall be identified as such.

Communication of this European Technical Assessment, including transmission by electronic means, shall be in full. However, partial reproduction may only be made with the written consent of the issuing Technical Assessment Body. Any partial reproduction shall be identified as such.

This European Technical Assessment may be withdrawn by the issuing Technical Assessment Body, in particular pursuant to information by the Commission in accordance with Article 25(3) of Regulation (EU) No 305/2011.

Specific Part

1 Technical description of the product

The fischer frame fixing in the range SXR 8, SXRL 8, SXR 10, SXRL 10 and SXRL 14 is a plastic anchor consisting of a plastic sleeve made of polyamide and an accompanying specific screw of galvanised steel, of galvanised steel with an additional Duplex-coating or of stainless steel.

The plastic sleeve is expanded by screwing in the specific screw which presses the sleeve against the wall of the drilled hole.

The product description is given in Annex A.

2 Specification of the intended use in accordance with the applicable European Assessment Document

The performances given in Section 3 are only valid if the anchor is used in compliance with the specifications and conditions given in Annex B.

The verifications and assessment methods on which this European Technical Assessment is based lead to the assumption of a working life of the anchors of at least 50 years. The indications given on the working life cannot be interpreted as a guarantee given by the producer, but are to be regarded only as a means for choosing the right products in relation to the expected economically reasonable working life of the works.

3 Performance of the product and references to the methods used for its assessment

3.1 Mechanical resistance and stability (BWR 1)

Essential characteristic	Performance
Resistance to steel failure under tension loading	See Annex C 1
Resistance to steel or polymer failure under shear loading	See Annex C 1
Resistance to pull-out or concrete failure or polymer failure under tension loading (base material group a)	See Annex C 1
Resistance in any load direction without lever arm (base material group b, c and d)	See Annexes C 3 - C 20
Edge distance and spacing (base material group a)	See Annex B 3
Edge distance and spacing (base material group b, c and d)	See Annex B 4
Displacements under short-term and long-term loading	See Annex C 2

3.2 Safety in case of fire (BWR 2)

Essential characteristic	Performance
Reaction to fire	Class A 1
Resistance to fire	See Annex C 2

English translation prepared by DIBt

4 Assessment and verification of constancy of performance (AVCP) system applied, with reference to its legal base

In accordance with the European Assessment Document EAD 330284-00-0604 the applicable European legal act is: 97/463/EC.

The system to be applied is: 2+

5 Technical details necessary for the implementation of the AVCP system, as provided for in the applicable European Assessment Document

Technical details necessary for the implementation of the AVCP system are laid down in the control plan deposited at Deutsches Institut für Bautechnik.

Issued in Berlin on 13 December 2018 by Deutsches Institut für Bautechnik

BD Dipl.-Ing. Andreas Kummerow
Head of Department

beglaubigt:
Aksünger

SXR

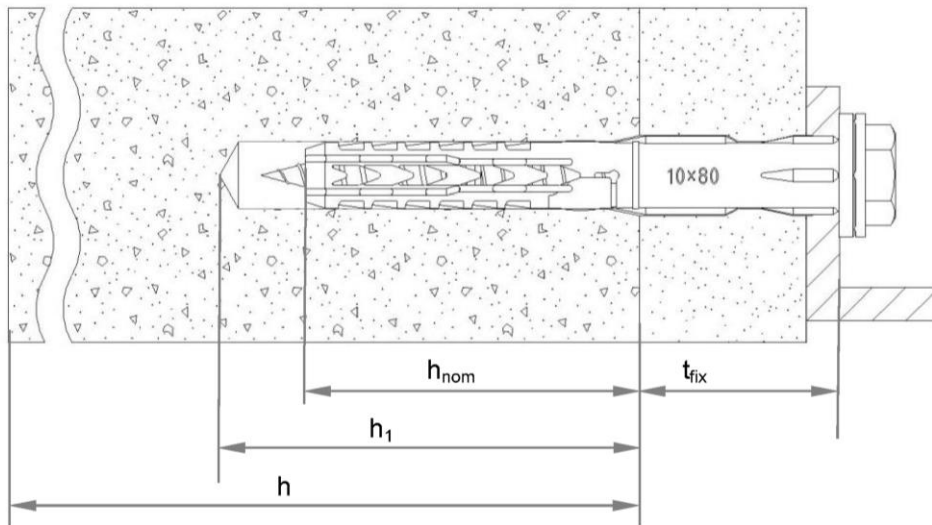

SXRL (e.g. with h_{nom2})

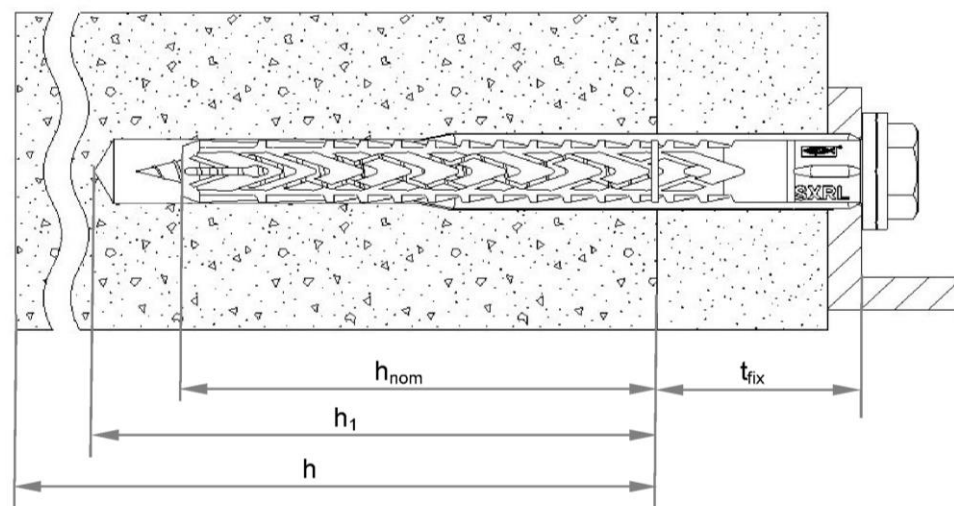

Legend

- h_{nom} = overall plastic anchor embedment depth in the base material
- h_1 = depth of drill hole to deepest point
- h = thickness of member (wall)
- t_{fix} = thickness of fixture and / or non-load bearing layer

fischer frame fixing SXR / SXRL

Product description
Installed anchor

Annex A 1

Anchor sleeves – flat collar versions of SXR and SXRL

SXR-version

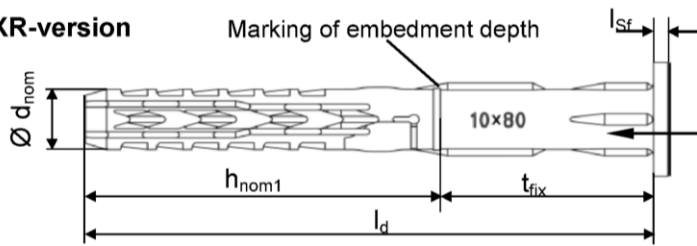

Marking:

Brand

Anchor type

Size

e.g. SXR 10x80

e.g. SXRL 14x100

SXRL-version

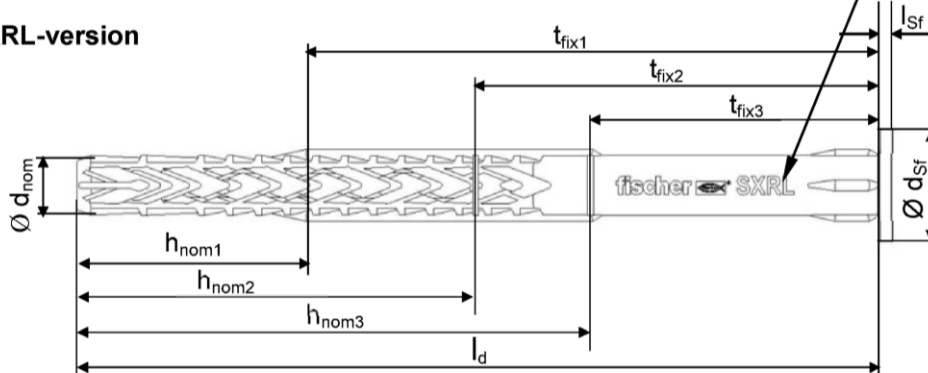

Countersunk sleeve version also available for both versions

Countersunk screws

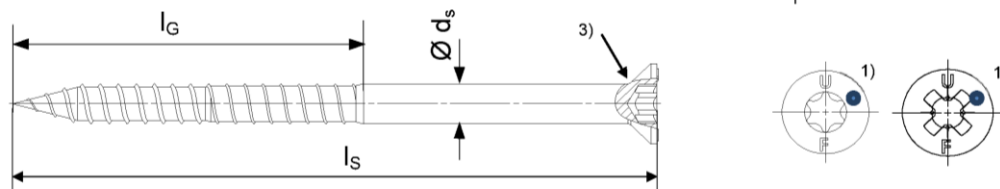

Hexagonal screw with washer

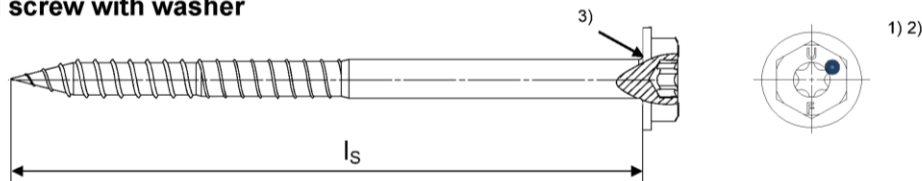

Hexagonal screw

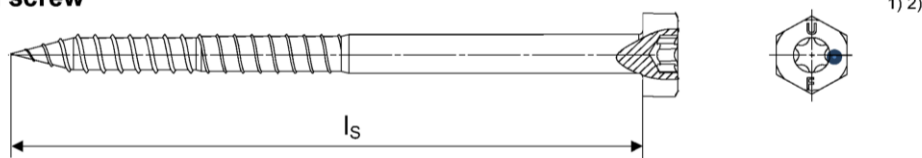

Stud screw

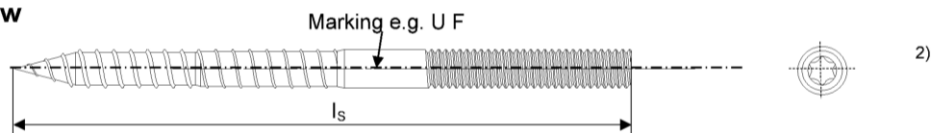

- 1) Additional marking for the special screw, stainless steel version: „e.g. A4“.
- 2) Internal driving feature for Torx bit is optional for hexagonal head and for stud screw
- 3) Optional additional version with underhead ribs

fischer frame fixing SXR / SXRL

Product description
Anchor types / special screws

Annex A 2

Table A3.1: Dimensions

Anchor type	Anchor sleeve								Special screw			
	h_{nom1} [mm]	h_{nom2} [mm]	h_{nom3} [mm]	$\varnothing d_{nom}$ [mm]	t_{fix} [mm]	min. l_d [mm]	max. l_d [mm]	$l_{sf}^{1)}$ [mm]	$\varnothing d_{sf}$ [mm]	$\varnothing d_s$ [mm]	l_G [mm]	l_s [mm]
SXR 8	50	-	-	8	≥ 1	51	360	1,8	> 15,0	6,0	≥ 55	$\geq l_d + 6$
SXRL 8	50	70	90	8	≥ 1	51	360	1,8	> 15,0	6,0	≥ 55	$\geq l_d + 6$
SXR 10	50	-	-	10	≥ 1	51	360	2,2	> 18,5	7,0	≥ 57	$\geq l_d + 7$
SXRL 10	50 ²⁾	70	90	10	≥ 1	51	360	2,2	> 18,5	7,0	≥ 57	$\geq l_d + 7$
SXRL 14	-	70	90	14	≥ 1	71	600	3,1	> 24,0	9,6	≥ 63	$\geq l_d + 10$

¹⁾ Only valid for flat collar version

²⁾ Marking optional

Table A3.2: Materials

Name	Material
Anchor sleeve	Polyamide, PA6, colour grey
Special screw	- Steel gvz A2G or A2F acc. to EN ISO 4042:2001 <u>or</u>
	- Steel gvz A2G or A2F acc. to EN ISO 4042:2001+ Duplex-coating type Delta-Seal in three layers (total layer thickness $\geq 6 \mu\text{m}$) <u>or</u>
	- Stainless steel acc. to EN 10 088-3:2014, e.g. 1.4301, 1.4567 (A2) <u>or</u>
	- Stainless steel acc. to EN 10 088-3:2014, e.g. 1.4401, 1.4571, 1.4578, 1.4362 (A4)

fischer frame fixing SXR / SXRL

Product description
Dimensions and materials

Annex A 3

Specifications of intended use

Anchorage subject to:

- Static and quasi-static loads.

Base materials:

- Reinforced or unreinforced normal weight concrete with strength classes \geq C12/15 (use category "a"), in accordance with EN 206:2013.
- Thin-walled concrete components (e.g. weather shells) \geq 40 mm thickness.
- Solid brick masonry (use category "b"), in accordance with to Annex C3 – C7.
Note: The characteristic resistance is also valid for larger brick sizes and higher compressive strength of the masonry unit.
- Hollow brick masonry (use category "c"), in accordance with to Annex B6 – B12 and C7 – C19.
- Autoclaved aerated concrete (use category "d"), in accordance with Annex C20.
- Mortar strength class of the masonry \geq M2,5 in accordance with EN 998-2:2010.
- For other comparable base materials of the base material group "a", "b", "c" and "d" the characteristic resistance of the anchor may be determined by job site tests in accordance with TR 051:2018-04.

Temperature Range:

SXR 8 and 10 and SXRL 8

- c: - 40 °C to 50 °C (max. short term temperature + 50 °C and max long term temperature + 30 °C)
- b: - 40 °C to 80 °C (max. short term temperature + 80 °C and max long term temperature + 50 °C)

SXRL 10 and 14

- c: - 20 °C to 50 °C (max. short term temperature + 50 °C and max long term temperature + 30 °C)
- b: - 20 °C to 80 °C (max. short term temperature + 80 °C and max long term temperature + 50 °C)

Use conditions (Environmental conditions):

- Structures subject to dry internal conditions: Special screw made of zinc coated steel, stainless steel A2 or A4.
- The specific screw made of galvanised steel or galvanised steel with an additional Duplex-coating may also be used in structures subject to external atmospheric exposure, if the area of the head of the screw is protected against moisture and driving rain after mounting of the fixing unit in this way, that intrusion of moisture into the anchor shaft is prevented. Therefore there shall be an external cladding or a ventilated rainscreen mounted in front of the head of the screw and the head of the screw itself shall be coated with a soft plastic, permanently elastic bitumen-oil-combination coating (e.g. undercoating or body cavity protection for cars).
- Structures subject to external atmospheric exposure (including industrial and marine environment) and to permanently damp internal condition, if no particular aggressive conditions exist: Special screw made of stainless steel A4.

Note: Particular aggressive conditions are e.g. permanent, alternating immersion in seawater or the splash zone of seawater, chloride atmosphere of indoor swimming pools or atmosphere with extreme chemical pollution (e.g. in desulphurization plants or road tunnels where de-icing materials are used).

Design:

- The anchorages are to be designed in accordance with TR 064:2018-05 under the responsibility of an engineer experienced in anchorages and masonry work.
- Verifiable calculation notes and drawings shall be prepared taking account of the loads to be anchored, the nature and strength of the base materials and the dimensions of the anchorage members as well as of the relevant tolerances. The position of the anchor is indicated on the design drawings.
- Fasteners are only to be used for multiple use for non-structural application, in accordance with TR 064:2018-05.

Installation:

- Hole drilling by the drilling method in accordance with Annex C3 – C20 for use categories "b", "c" and "d".
- Anchor installation carried out by appropriately qualified personnel and under the supervision of the person responsible for technical matters of the site.
- Installation temperature from SXR 8/10, SXRL 8 and SXRL 14: - 5 °C to + 40 °C
SXRL 10: - 20 °C to + 40 °C
- Exposure to UV due to solar radiation of the not protected anchor \leq 6 weeks.
- No ingress of water in the borehole at temperatures $<$ 0 °C

fischer frame fixing SXR / SXRL

Anhang B 1

Intended use
Specifications

Table B2.1: Installation parameters

Anchor type		SXR 8	SXRL 8	SXR 10	SXRL 10	SXRL 14
Drill hole diameter	$d_0 =$ [mm]	8	8	10	10	14
Cutting diameter of drill bit	$d_{cut} \leq$ [mm]	8,45	8,45	10,45	10,45	14,45
Overall plastic anchor embedment depth in the base material ^{1) 2)}	$h_{nom1} \geq$ [mm]	50	50	50	50	-
	$h_{nom2} \geq$ [mm]	-	70	-	70	70
	$h_{nom3} \geq$ [mm]	-	90	-	90	90
Depth of drill hole to deepest point ¹⁾	$h_{1,1} \geq$ [mm]	60	60	60	60	-
	$h_{1,2} \geq$ [mm]	-	80	-	80	85
	$h_{1,3} \geq$ [mm]	-	100	-	100	105
Diameter of clearance hole in the fixture	$d_f \leq$ [mm]	8,5	9,5	10,5/12,5 ³⁾	10,5/12,5 ³⁾	15,4

¹⁾ See Annex A1.

²⁾ For hollow and perforated masonry: If the embedment depth is higher than h_{nom} given in the Table B2.1, job site tests have to be carried out in accordance with TR 051:2018-04.

³⁾ See Table C2.1.

Table B2.2: Assignment of h_{nom} , l_d and t_{fix} for use in thin concrete slabs (e.g. weather resistant shells of external wall panels) and pre-stressed concrete core slabs

Anchor type	SXR 10 / SXRL 10			
	l_d		$h_{nom} \geq 50$ mm	
	SXR	SXRL	$t_{fix, min}$	$t_{fix, max}$
Use category "a"	52	-	1	2
	60	60	1	10
	80	80	21	30
	100	100	41	50
	120	120	61	70
	140	140	81	90
	160	160	101	110
	180	180	121	130
	200	200	141	150
	230	230	171	180
	260	260	201	210
	-	290	231	240
	[mm]			

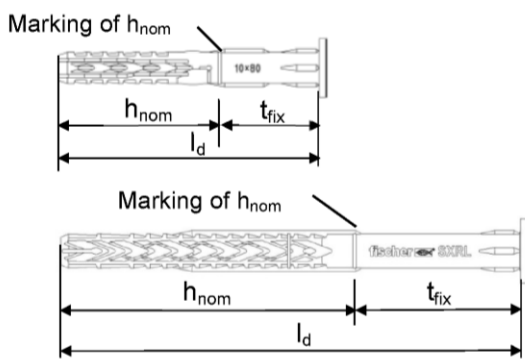

Table B2.3: Installation parameters for use in pre-stressed hollow concrete core slabs

Anchor type	SXRL 10			
	Mirror thickness	d_b	\geq [mm]	30
	Overall plastic anchor embedment depth in the base material	h_{nom}	[mm]	50 to 59

fischer frame fixing SXR / SXRL

Intended use

Installation parameters, parameters for use in thin skins (weather resistant concrete skins of external wall panels) and pre-stressed hollow concrete core slabs

Anhang B 2

Table B3.1: Minimum thickness of member, edge distance and spacing in concrete

Anchor Type	$h_{nom} \geq$ [mm]	Concrete Strength class	Min. thickness of member h_{min} [mm]	Characteristic edge distance c_{cr} [mm]	Characteristic spacing s_{cr} [mm]	Min. spacing and edge distances ¹⁾ [mm]
SXR 8	50	\geq C16/20	100	50	65	$s_{min} = 50$ for $c \geq 50$ $c_{min} = 50$ for $s \geq 50$
		C12/15		70	70	$s_{min} = 70$ for $c \geq 70$ $c_{min} = 70$ for $s \geq 70$
SXRL 8	50	\geq C16/20	80	60	75	$s_{min} = 60$ for $c \geq 60$ $c_{min} = 60$ for $s \geq 60$
		C12/15		85	90	$s_{min} = 85$ for $c \geq 85$ $c_{min} = 85$ for $s \geq 85$
	70	\geq C16/20	100	60	90	$s_{min} = 60$ for $c \geq 60$ $c_{min} = 60$ for $s \geq 60$
		C12/15		85	105	$s_{min} = 85$ for $c \geq 85$ $c_{min} = 85$ for $s \geq 85$
SXR 10	50	\geq C16/20	100 ⁴⁾	100	90	$s_{min} = 50$ for $c \geq 150$ $c_{min} = 60$ for $s \geq 70$
		C12/15		140	100	$s_{min} = 70$ for $c \geq 210$ $c_{min} = 85$ for $s \geq 100$
SXRL 10	50	\geq C16/20	100 ⁴⁾	100	105	$s_{min} = 50$ for $c \geq 100$ $c_{min} = 50$ for $s \geq 125$
		C12/15		140	120	$s_{min} = 70$ for $c \geq 140$ $c_{min} = 70$ for $s \geq 175$
	70 ²⁾	\geq C16/20		100	105	$s_{min} = 50$ for $c \geq 100$ $c_{min} = 50$ for $s \geq 125$
		C12/15		140	120	$s_{min} = 70$ for $c \geq 140$ $c_{min} = 70$ for $s \geq 175$
SXRL 14	70 ³⁾	\geq C16/20	110	100	120	$s_{min} = 60$ for $c \geq 100$ $c_{min} = 60$ for $s \geq 125$
		C12/15		140	135	$s_{min} = 85$ for $c \geq 140$ $c_{min} = 85$ for $s \geq 175$

1) Intermediate values by linear interpolation.

2) Values valid for reinforced concrete.

Please note: Values for non-reinforced concrete are $h_{min} = 110$ mm and $c_{min} = s_{min} = 80$ mm for concrete \geq C16/20 and $c_{min} = s_{min} = 110$ mm for C12/15.

3) Please note: Values for non-reinforced concrete are $h_{min} = 110$ mm and $c_{min} = 100$ and $s_{min} = 80$ mm for concrete \geq C16/20 and $c_{min} = 140$ and $s_{min} = 110$ mm for C12/15.

4) Also valid for thin concrete slabs $h \geq 40$ mm, $h_{nom} = 50$ mm to 59 mm

Fixing points with a spacing $a \leq s_{cr}$ are considered as a group with a max. characteristic resistance $N_{Rk,p}$ acc. to Table C1.3. For a spacing $a > s_{cr}$ the anchors are considered as single anchors, each with a characteristic resistance $N_{Rk,p}$ acc. to Table C1.3.

Scheme of distance and spacing in concrete

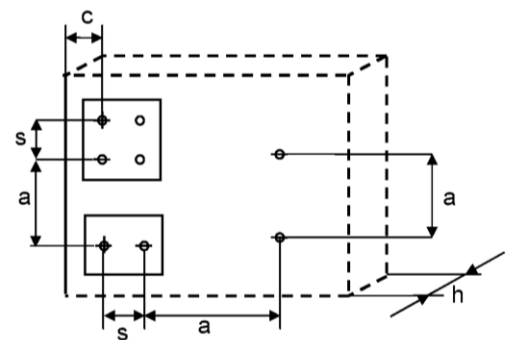

fischer frame fixing SXR / SXRL

Intended use

Edge distances and spacings for use in concrete

Anhang B 3

Table B4.1: Minimum thickness of member, edge distance and spacing in masonry

Anchor type		SXR 8	SXRL 8	SXR 10	SXRL 10	SXRL 14
Minimum thickness of member	h_{min} [mm]	100	115	100	110	115
Single anchor						
Minimum spacing	a_{min} [mm]	250	250	250	250	250
Minimum edge distance	c_{min} [mm]	100	100	100	100	100
Anchor group						
Minimum spacing perpendicular to free edge	$s_{1,min}$ [mm]	100	100	100	100	100
Minimum spacing parallel to free edge	$s_{2,min}$ [mm]	100	100	100	100	100
Minimum edge distance	c_{min} [mm]	100	100	100	100	100
Distance between anchor groups and / or single anchors	a [mm]	250				

Scheme of distance and spacing in masonry and aerated concrete AAC

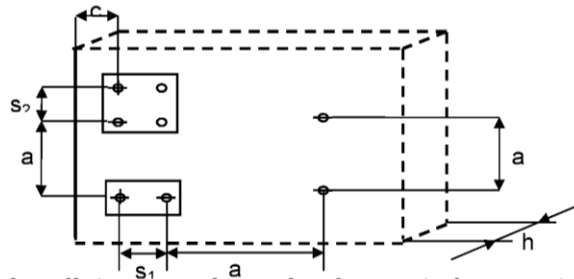

Table B4.2: Minimum thickness of member, edge distance and spacing in aerated concrete AAC

Anchor type		SXRL 8	SXR 10	SXRL 10	SXRL 14
Compressive strength	f_b [N/mm ²]	≥ 2 to < 6	≥ 6	≥ 2	≥ 2 to < 4
Nominal embedment depth	$h_{nom} \geq$ [mm]	70 and 90	50	70 90	70 90 70 90
Minimum thickness of member	h_{min} [mm]	175	100	100 120	175 300
Single anchor					
Minimum spacing	a_{min} [mm]	250	250	250	250
Minimum edge distance	c_{min} [mm]	60	80	100	120
Anchor group					
Minimum spacing perpendicular to free edge	$s_{1,min}$ [mm]	80	110	200	100 / 120 ¹⁾
Minimum spacing parallel to free edge	$s_{2,min}$ [mm]	80	110	400	100 / 120 ¹⁾
Minimum edge distance	c_{min} [mm]	90	110	100	120
Distance between anchor groups and / or single anchors	a [mm]	250 ²⁾			

¹⁾ Valid for AAC ≥ 600 kg/m³

²⁾ For SXR 10 $a \geq 400$ mm

fischer frame fixing SXR / SXRL

Intended use

Edge distances and spacing for use in masonry and in autoclaved aerated concrete AAC

Anhang B 4

Installation instructions (the following pictures show fixing through timber)

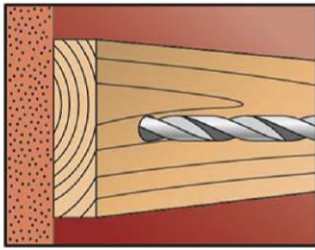

1. Drill the bore hole acc. to Table B2.1 using the drill method described in the corresponding Annex C.

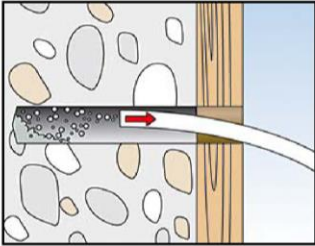

2. Use category „a“, „b“, „d“: Remove dust from borehole.

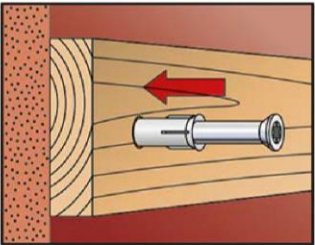

3. Insert anchor (screw and plug) by using a hammer until the collar of the plastic sleeve is flush with the surface of the fixture.

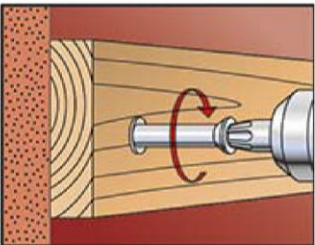

4. The screw is screwed-in until the head of the screw touches the sleeve. The anchor is correctly mounted, when the head of the screw fits tight on the surface and cannot be screwed-in any further.

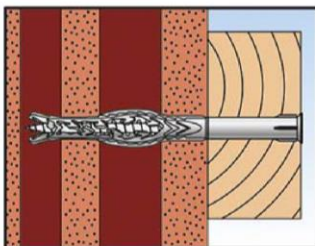

5. Correctly installed anchor in hollow masonry.

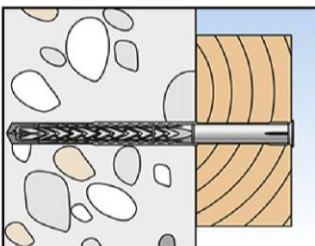

6. Correctly installed anchor in concrete.

fischer frame fixing SXR / SXRL

Intended use
Installation instructions

Anhang B 5

Table B6.1: Summary of hollow and perforated bricks – see Annex C 7 – C 9

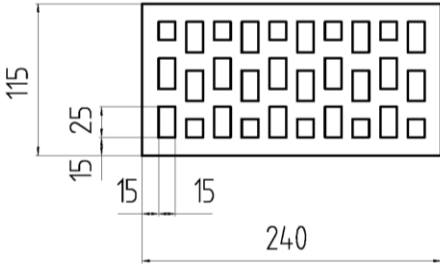
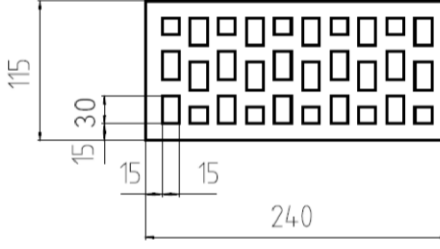
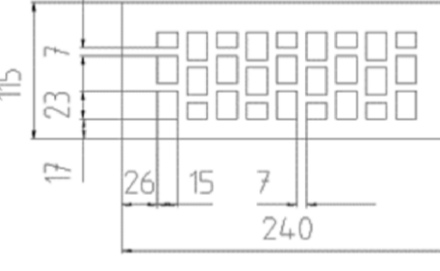
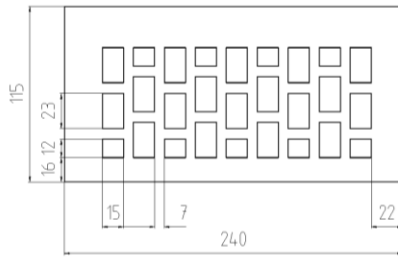
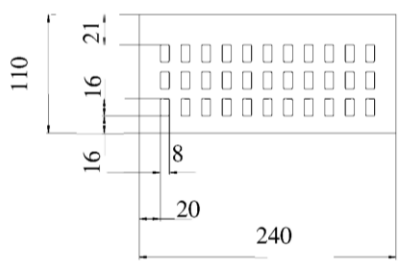
Brick No./ Country	Dimensions	Brick drawing	See Annex
S1/DE	2 DF 240 x 115 x 113 mm		C 7
S2/DE	2 DF 240 x 115 x 113 mm		C 8
S3/DE	NF 240 x 115 x 71 mm		C 8
S4/DE	2 DF 240 x 115 x 113 mm		C 8
S5/DE	DF 240 x 110 x 52 mm		C 9

fischer frame fixing SXR / SXRL

Intended use
Summary of hollow and perforated bricks

Anhang B 6

Table B7.1: Summary of hollow and perforated bricks – see Annex C 9 – C 10

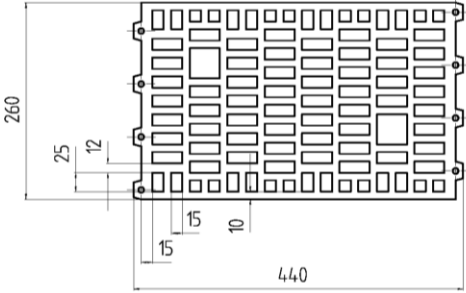
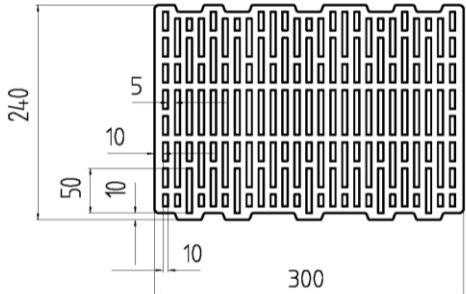
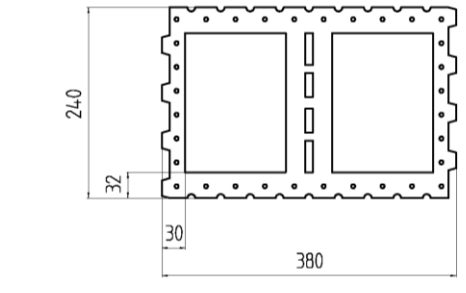
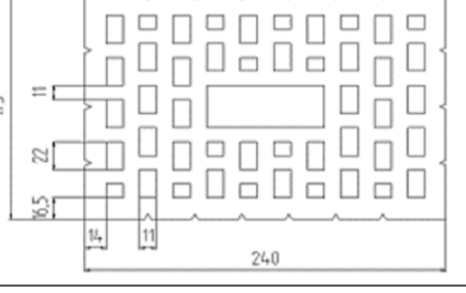
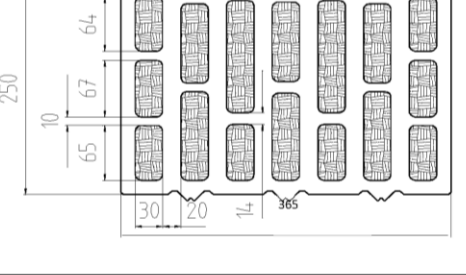
Brick No./ Country	Dimensions	Brick drawing	See Annex
S6/DE	10 DF 440 x 240 x 260 mm		C 9
S7/DE	10 DF 300 x 240 x 240 mm		C 9
S8/DE	12 DF 380 x 240 x 240 mm		C 10
S9/DE	3 DF 240 x 175 x 113 mm		C 10
S10/DE	12 DF 365 x 250 x 240 mm		C 10

fischer frame fixing SXR / SXRL

Intended use
Summary of hollow and perforated bricks

Anhang B 7

Table B8.1: Summary of hollow and perforated bricks – see Annex C11 – C12

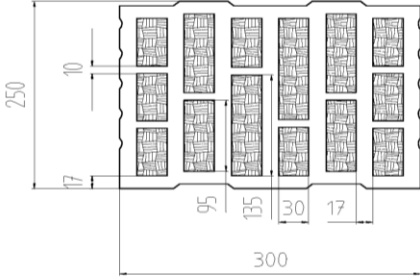
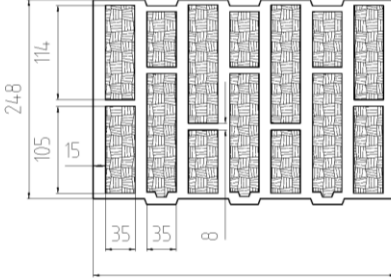
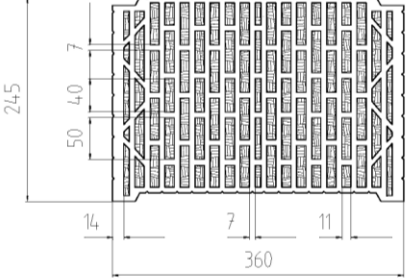
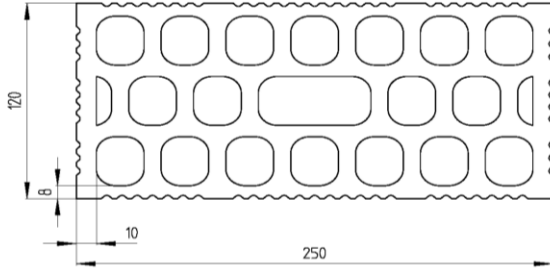
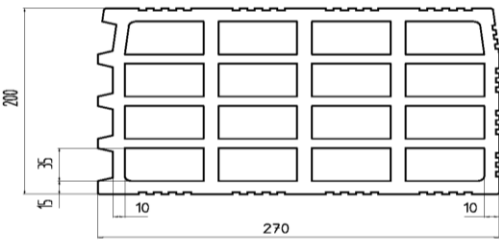
Brick No./ Country	Dimensions	Brick drawing	See Annex
S11/DE	10 DF 300 x 250 x 240 mm		C 11
S12/DE	10 DF 365 x 248 x 240 mm		C 11
S13/DE	10 DF 360 x 245 x 240 mm		C 11
S14/IT	250 x 120 x 190 mm		C 12
S15/FR	500 x 200 x 270 mm		C 12

fischer frame fixing SXR / SXRL

Intended use
Summary of hollow and perforated bricks

Anhang B 8

Table B9.1: Summary of hollow and perforated bricks – see Annex C12 – C14

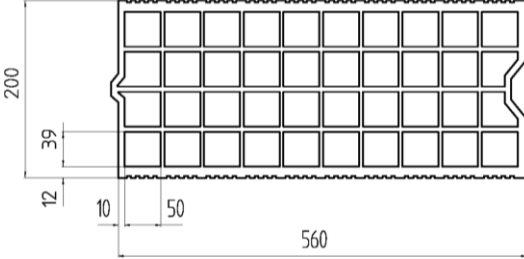
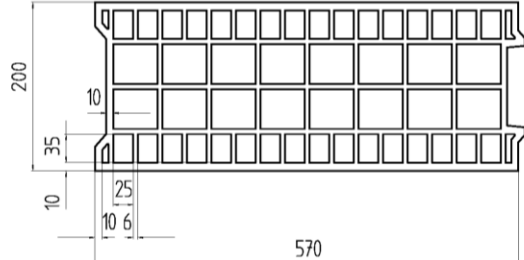
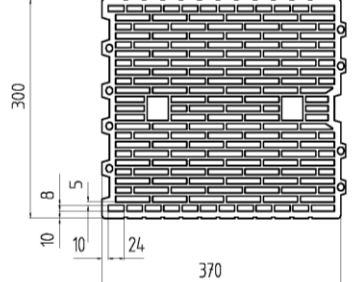
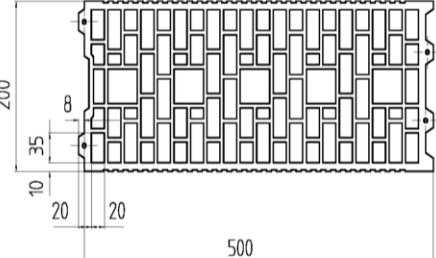
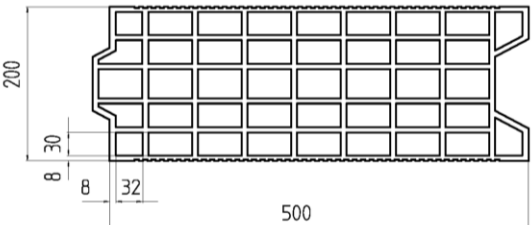
Brick No./ Country	Dimensions	Brick drawing	See Annex
S16/FR	560 x 200 x 275 mm		C 12
S17/FR	570 x 200 x 315 mm		C 13
S18/FR	370 x 300 x 250 mm		C 13
S19/FR	500 x 200 x 275 mm		C 13
S20/FR	500 x 200 x 220 mm		C 14

fischer frame fixing SXR / SXRL

Anhang B 9

Intended use
Summary of hollow and perforated bricks

Table B10.1: Summary of hollow and perforated bricks – see Annex C14 – C15

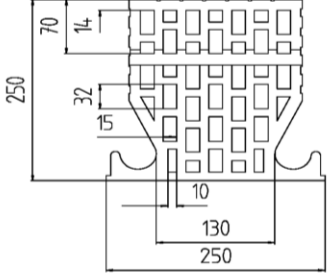
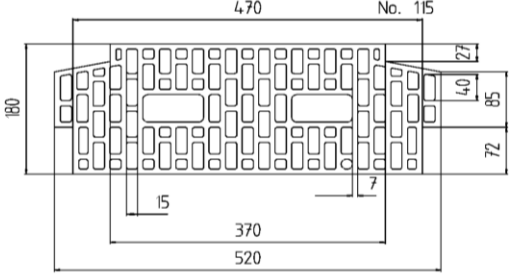
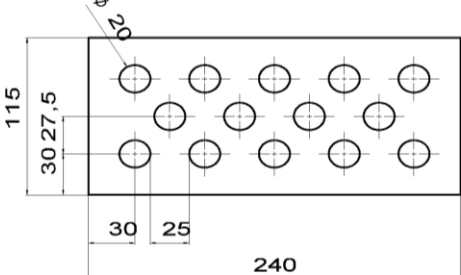
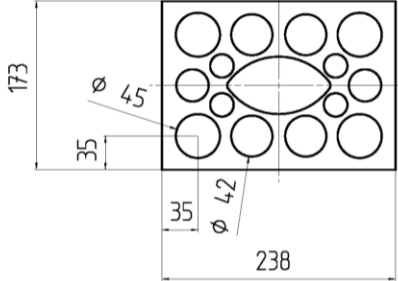
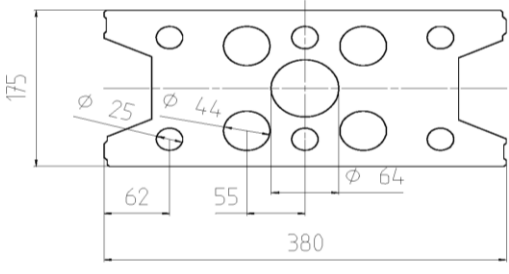
Brick No./ Country	Dimensions	Brick drawing	See Annex
S21/DE	250 x 250 x 190 mm		C 14
S22/DE	520 x 180 x 250 mm		C 14
S23/DE	2 DF 240 x 115 x 113 mm		C 15
S24/DE	3 DF 240 x 175 x 113 mm		C 15
S25/DE	9 DF 380 x 175 x 240 mm		C 15

fischer frame fixing SXR / SXRL

Intended use
Summary of hollow and perforated bricks

Anhang B 10

Table B11.1: Summary of hollow and perforated bricks – see Annex C16 – C17

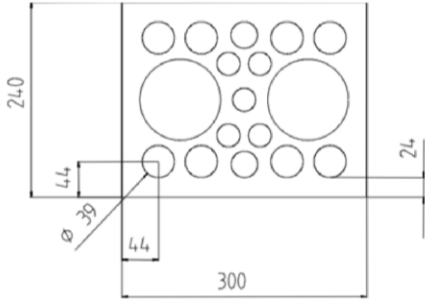
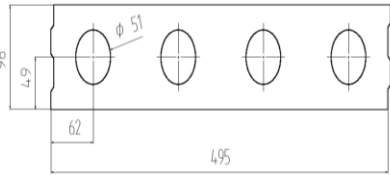
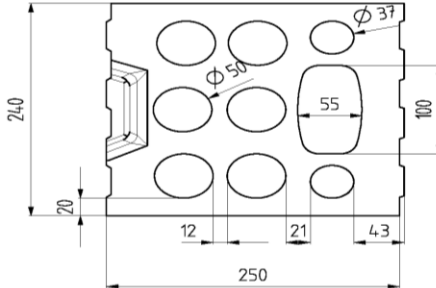
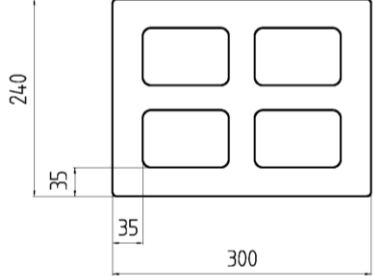
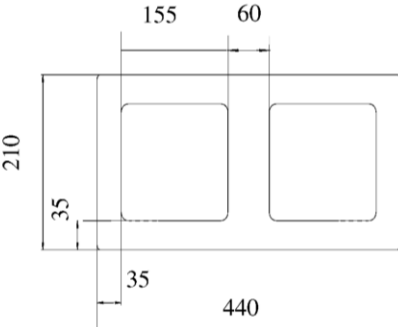
Brick No./ Country	Dimensions	Brick drawing	See Annex
S26/DE	5 DF 300 x 240 x 113 mm		C 16
S27/DE	2 DF 495 x 98 x 245 mm		C 16
S28/DE	9 DF 250 x 240 x 240 mm		C 16
S29/DE	300 x 240 x 240 mm		C 17
S30/IE	440 x 210 x 215 mm		C 17

fischer frame fixing SXR / SXRL

Intended use
Summary of hollow and perforated bricks

Anhang B 11

Table B12.1: Summary of hollow and perforated bricks – see Annex C17 – C19

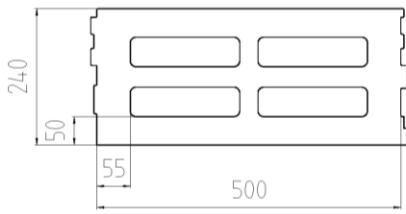
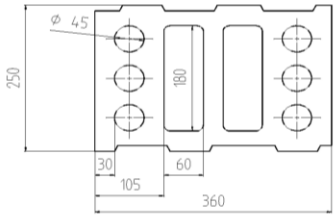
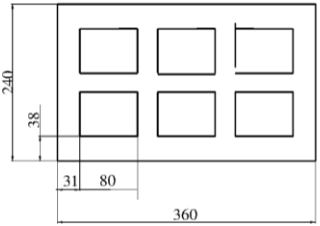
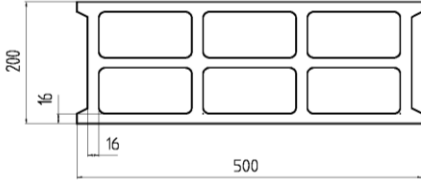
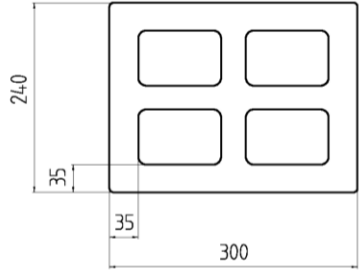
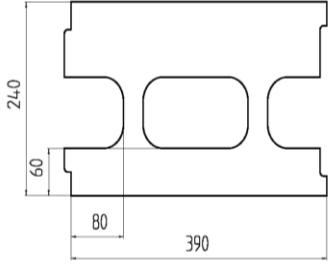
Brick No./ Country	Dimensions	Brick drawing	See Annex
S31/DE	500 x 240 x 240 mm		C 17
S32/DE	360 x 250 x 250 mm		C 18
S33/DE	360 x 240 x 240 mm		C 18
S34/FR	500 x 200 x 200 mm		C 18
S35/DE	300 x 240 x 240 mm		C 19
S36/DE	390 x 240 x 240		C 19

fischer frame fixing SXR / SXRL

Intended use
Summary of hollow and perforated bricks

Anhang B 12

Table C1.1: Characteristic resistance of the screw

Failure of expansion element (special screw)		SXR 8 / SXRL 8		SXR 10 / SXRL 10		SXRL 14	
		galvanised steel	stainless steel (A2 and A4)	galvanised steel	stainless steel (A2 and A4)	galvanised steel	stainless steel (A2 and A4)
Characteristic tension resistance	$N_{Rk,s}$ [kN]	14,8	14,3	21,7 24,9 ²⁾	21,7	43,4	42,0
Partial safety factor	γ_{Ms} ¹⁾	1,50	1,55	1,55	1,55	1,50	1,55
Characteristic shear resistance	$V_{Rk,s}$ [kN]	7,4	7,1	10,8 12,4 ²⁾	10,8	21,7	21,0
Partial safety factor	γ_{Ms} ¹⁾	1,25	1,29	1,29	1,29	1,25	1,29

¹⁾ In absence of other national regulations.

²⁾ Only for SXRL 10: "High load" screw version on request only for countersunk screws – head marking is ●●

Table C1.2: Characteristic bending resistance of the screw

Anchor type		SXR 8 / SXRL 8		SXR 10 / SXRL 10		SXRL 14			
		galvanised steel	stainless steel (A2 and A4)	galvanised steel	stainless steel (A2 and A4)	galvanised steel		stainless steel (A2 and A4)	
Overall plastic anchor embedment depth in the base material						h_{nom2} 70mm	h_{nom3} 90mm	h_{nom2} 70mm	h_{nom3} 90mm
Characteristic bending resistance	$M_{Rk,s}$ [Nm]	12,4	12,0	20,6 23,6 ²⁾	20,6	48,7	62,5	47,0	60,5
Partial safety factor	γ_{Ms} ¹⁾	1,25	1,29	1,29	1,29	1,25		1,29	

¹⁾ In absence of other national regulations.

²⁾ Only for SXRL 10: "High load" screw version on request only for countersunk screws – head marking is ●●

Table C1.3: Characteristic resistance for use in concrete (use cat. "a")

Pull-out failure (plastic sleeve)		SXR 8	SXRL 8	SXR 10	SXRL 10	SXRL 14
Embedment depth h_{nom} [mm]		50	50 70	50	50 70	70
Concrete \geq C12/15						
Characteristic resistance 30/50 °C	$N_{Rk,p}$ [kN]	3,0	4,0 5,0	5,0	5,5 6,5	8,5
Characteristic resistance 50/80 °C	$N_{Rk,p}$ [kN]	2,5 3,0 ²⁾	4,0 5,0	4,5	5,0 6,5	8,5
Concrete \geq C12/15 (e.g. weather resistant shells of external wall panels)						
Characteristic resistance 30/50 °C	$N_{Rk,p}$ [kN]	$h \geq 40$ mm	- - -	3,5	2,5 3,0 ²⁾	- -
Characteristic resistance 50/80 °C	$N_{Rk,p}$ [kN]	$h \geq 40$ mm	- - -	3,0	2,5 3,0 ²⁾	- -
Concrete \geq C45/55 in pre-stressed concrete core slabs						
Characteristic resistance 50/80 °C	$N_{Rk,p}$ [kN]	$d_b \geq 30$ mm	- - -		3,5 4,0 ³⁾	- -
		$d_b \geq 40$ mm	- - -		5,5 6,0 ³⁾	- -
Partial safety factor		γ_{Mc} ¹⁾		1,8		

¹⁾ In absence of other national regulations.

²⁾ Value corresponds to concrete class \geq C16/20.

³⁾ only valid for temperature range 30 / 50 °C

fischer frame fixing SXR / SXRL

Performances

Characteristic resistance and characteristic bending resistance of the screw
Characteristic resistance for use in concrete

Annex C 1

Table C2.1: Displacements¹⁾ under tension and shear loading in concrete and masonry

Anchor type	h _{nom} [mm]	F [kN]	Tension load ²⁾		Shear load ²⁾	
			δ _{NO} [mm]	δ _{N∞} [mm]	δ _{VO} [mm]	δ _{V∞} [mm]
SXR 8	50	1,2	0,65	1,30	1,02	1,53
SXRL 8	50	1,6	0,56	1,12	2,00	3,00
	70	2,0	0,64	1,28	2,30	3,45
SXR 10	50	2,0	1,29	2,58	1,15 ³⁾ /3,05 ⁴⁾	1,74 ³⁾ /4,58 ⁴⁾
SXRL 10	50	2,2	0,58	1,16	1,96	2,94
	70	2,6	1,67	3,34	1,15 ³⁾ /3,05 ⁴⁾	1,74 ³⁾ /4,58 ⁴⁾
SXRL 14	70	3,40	0,39	0,63	2,79	4,19

1) Valid for all ranges of temperatures.

2) Intermediate values by linear interpolation.

3) Valid for diameter in the clearance hole ≤ 10,5 mm (see Table B2.1).

4) Valid for diameter in the clearance hole = 12,5 mm (see Table B2.1).

Table C2.2: Displacements¹⁾ under tension and shear loading in autoclaved aerated concrete AAC

Anchor type	f _b [N/mm ²]	h _{nom} [mm]	F [kN]	Tension load ²⁾		Shear load ²⁾	
				δ _{NO} [mm]	δ _{N∞} [mm]	δ _{VO} [mm]	δ _{V∞} [mm]
SXRL 8	≥ 2	70/90	0,14/0,21	0,45/0,55	0,90/1,10	0,28/0,42	0,42/0,63
	≥ 6	70/90	1,07	0,73/0,80	1,46/1,60	2,14	3,21
SXR 10	≥ 2	50	0,32	0,03	0,06	0,21	0,31
SXRL 10	≥ 2	70/90	0,32	0,23	0,46	0,64	0,96
	≥ 6	70/90	1,43	0,65	1,30	2,86	4,29
SXRL 14	≥ 2	70/90	0,32/0,43	0,19/0,25	0,38/0,50	0,64/0,86	0,96/1,29
	≥ 3	70/90	0,60/0,77	0,23/0,31	0,45/0,63	1,19/1,54	1,79/2,31
	≥ 4	70/90	0,88/1,11	0,26/0,38	0,53/0,76	1,75/2,22	2,62/3,33
	≥ 6	70/90	1,43/1,79	0,34/0,51	0,68/1,02	2,86/3,58	4,29/5,37

1) Valid for all ranges of temperatures.

2) Intermediate values by linear interpolation.

Table C2.3: Values under fire exposure in concrete C20/25 to C50/60 in any load direction, no permanent centric tension load and without lever arm

Anchor type	Fire resistance class	F _{Rk,fi,90}	γ _{M,fi} ¹⁾
SXR 10 / SXRL 10 / SXRL 14	R 90	≤ 0,8 kN	1,0

1) In absence of other national regulations.

If one-side fire load, see table B3.1 for edge distance

In case of fire attack from more than one side the minimum edge distance shall be c ≥ 300 mm, c ≥ 2 · h_{ef}; the bigger value is decisive

fischer frame fixing SXR / SXRL

Performances

Displacements under tension and shear loading in concrete, masonry and aerated concrete

Annex C 2

Table C3.1: Characteristic resistance F_{Rk} in [kN] in solid masonry (use category “b”)

Base material [Supplier Title] Geometry, DF or nom. size (L x W x H) [mm] and drilling method	Min. com- pressive strength f_b [N/mm ²] / bulk density ρ [kg/dm ³]	Characteristic resistance F_{Rk} [kN] 50/80°C									
		SXR 8	SXRL 8			SXR 10	SXRL 10		SXRL 14		
		h_{nom} [mm]									
		≥ 50	≥ 50	≥ 70	≥ 90	≥ 50	≥ 50	≥ 70	≥ 70	≥ 90	
Clay brick Mz, acc. to EN 771-1:2011 e.g. Schlagmann DE 3 DF (240x175x113) hammer drilling	20/1,8	3,0	-	-	-	2,0 4,0 ⁴⁾ 4,5 ⁶⁾	-	-	-	-	
	10/1,8	2,0	-	-	-	3,0 ⁴⁾	-	-	-	-	
Clay brick Mz, acc. to EN 771-1:2011 e.g. Schlagmann DE e.g. Ebersdobler DE NF (240x115x71) hammer drilling	36/1,8	2,5	3,0	4,0 4,5 ³⁾	⁸⁾	5,0	3,5	4,0 5,5 ³⁾	4,0 6,0 ⁴⁾ 7,0 ⁶⁾	⁸⁾	
	20/1,8	2,5	3,0	4,0 4,5 ³⁾	⁸⁾	3,0 3,5 ²⁾	3,5	4,0 5,5 ³⁾	4,0 6,0 ⁴⁾ 7,0 ⁶⁾	⁸⁾	
	12/1,8	2,0	2,0	2,5	⁸⁾	2,0	2,0	4,0 5,5 ³⁾	3,0 4,5 ⁴⁾ 5,0 ⁶⁾	⁸⁾	
	10/1,8	2,0	2,0	2,5	⁸⁾	2,0	-	3,5 4,5 ³⁾	3,0 4,5 ⁴⁾ 5,0 ⁶⁾	⁸⁾	
Clay brick Mz, acc. to EN 771-1:2011 e.g. Wienerberger, DK DF (240x115x52) hammer drilling	28/1,8	3,0	2,5	3,0 3,5 ²⁾	⁸⁾	3,0	3,0 4,5 ³⁾ 5,0 ⁵⁾	5,5 6,5 ³⁾	-	-	
	20/1,8	2,0	2,5	3,0 3,5 ²⁾	⁸⁾	2,0	3,0 4,5 ³⁾ 5,0 ⁵⁾	4,0 4,5 ³⁾	-	-	
	16/1,8	1,5	2,5	3,0 3,5 ²⁾	⁸⁾	1,5	3,0 4,5 ³⁾ 5,0 ⁵⁾	3,0 3,5 ³⁾	-	-	
	12/1,8	1,5	1,5 2,0 ²⁾	2,0 2,5 ²⁾	⁸⁾	1,2	2,5 3,5 ³⁾	2,5 3,0 ³⁾	-	-	
	10/1,8	1,5	1,2 1,5 ²⁾	⁸⁾	⁸⁾	1,2	-	2,5 3,0 ³⁾	-	-	
Partial safety factor	γ_{Mm} ¹⁾	2,5									

1) In absence of other national regulations.

2) Only valid for temperature range 30/50° C.

3) Only valid for edge distance $c \geq 150$ mm; intermediate values by linear interpolation.

4) Only valid for edge distance $c \geq 200$ mm; intermediate values by linear interpolation.

5) Only valid for edge distance $c \geq 150$ mm for temperature range 30/50° C; intermediate values by linear interpolation.

6) Only valid for edge distance $c \geq 200$ mm for temperature range 30/50° C; intermediate values by linear interpolation.

8) Values of lower h_{nom} can also be taken for next higher h_{nom} .

fischer frame fixing SXR / SXRL

Performances
Characteristic resistance for use in solid masonry

Annex C 3

Table C4.1: Characteristic resistance F_{Rk} in [kN] in solid masonry (use category “b”)

Base material [Supplier Title] Geometry, DF or nom. size (L x W x H) [mm] and drilling method	Min. compressive strength f_b [N/mm ²] / bulk density ρ [kg/dm ³]	Characteristic resistance F_{Rk} [kN] 50/80°C									
		SXR 8	SXRL 8		SXR 10	SXRL 10		SXRL 14			
		h_{nom} [mm]									
		≥ 50	≥ 50	≥ 70	≥ 90	≥ 50	≥ 50	≥ 70	≥ 70	≥ 90	
Calcium silicate solid brick KS , acc. to EN 771-2:2011 e.g. <i>KS Wemding DE NF</i> (240x115x71) hammer drilling	36/2,0	-	-	-	-	5,0	3,5 4,0 ³⁾	8)	-	-	
	20/2,0	-	-	-	-	3,0 3,5 ²⁾	3,5 4,0 ³⁾	8)	-	-	
	20/1,8	2,5	2,5	3,0	8)	2,5 4,0 ⁴⁾	-	3,5	4,5 5,0 ⁴⁾ 6,0 ⁶⁾	8)	
	10/2,0	-	-	-	-	2,0	2,0 2,5 ³⁾	8)	-	-	
	10/1,8	2,0	2,0	2,0	8)	1,5	-	2,5	3,0 3,5 ⁴⁾ 4,0 ⁶⁾	8)	
Calcium silicate solid brick KS , acc. to EN 771-2:2011 e.g. <i>KS Wemding 12 DF</i> (495x175x240) hammer drilling	28/2,0	3,0	-	-	-	5,0	-	-	-	-	
	20/2,0	3,0	-	-	-	4,5	-	-	-	-	
	20/1,8	-	-	-	-	-	-	6,5 8,5 ⁴⁾	4,0 11,0 ⁴⁾ 11,5 ⁶⁾	8)	
	16/1,8	-	-	-	-	-	-	6,5 8,5 ⁴⁾	4,0 11,0 ⁴⁾ 11,5 ⁶⁾	8)	
	12/1,8	-	-	-	-	-	-	6,5 8,5 ⁴⁾	4,0 11,0 ⁴⁾ 11,5 ⁶⁾	8)	
	10/2,0	2,5	-	-	-	3,0	-	-	-	-	
	10/1,8	-	-	-	-	-	-	5,5 7,0 ⁴⁾	3,5 9,0 ⁴⁾ 9,5 ⁶⁾	8)	
	8/1,8	-	-	-	-	-	-	4,0 5,5 ⁴⁾	2,5 7,5 ⁴⁾	8)	
Partial safety factor γ_{Mm} ¹⁾	2,5										

1) In absence of other national regulations.

2) Only valid for temperature range 30/50° C.

3) Only valid for edge distance $c \geq 150$ mm; intermediate values by linear interpolation.

4) Only valid for edge distance $c \geq 200$ mm; intermediate values by linear interpolation.

5) Only valid for edge distance $c \geq 150$ mm for temperature range 30/50° C; intermediate values by linear interpolation.

6) Only valid for edge distance $c \geq 200$ mm for temperature range 30/50° C; intermediate values by linear interpolation.

8) Values of lower h_{nom} can also be taken for next higher h_{nom} .

fischer frame fixing SXR / SXRL

Performances
Characteristic resistance for use in solid masonry

Annex C 4

Table C5.1: Characteristic resistance F_{Rk} in [kN] in solid masonry (use category “b”)

Base material [Supplier Title] Geometry, DF or nom. size (L x W x H) [mm] and drilling method	Min. com- pressive strength f_b [N/mm ²] / bulk density ρ [kg/dm ³]	Characteristic resistance F_{Rk} [kN] 50/80°C								
		SXR 8	SXRL 8			SXR 10	SXRL 10		SXRL 14	
		h _{nom} [mm]								
		≥ 50	≥ 50	≥ 70	≥ 90	≥ 50	≥ 50	≥ 70	≥ 70	≥ 90
Calcium silicate solid brick KS , acc. to EN 771-2:2011 e.g. <i>KS Wemding DE</i> 8 DF (495x115x240) hammer drilling	16/2,0	-	3,0 4,5 ³⁾ 5,0 ⁶⁾	3,5 5,0 ³⁾ 6,0 ⁴⁾ 6,5 ⁶⁾	8)	-	3,5 5,0 ³⁾ 6,0 ⁴⁾ 6,5 ⁶⁾	8)	-	-
	12/2,0	-	2,5 3,0 ³⁾ 3,5 ⁵⁾	2,5 4,0 ³⁾ 4,5 ⁴⁾ 5,0 ⁶⁾	8)	-	2,5 4,0 ³⁾ 4,5 ⁴⁾ 5,0 ⁶⁾	8)	-	-
Lightweight solid brick Vbl , acc. to EN 771-3:2011 e.g. <i>KLB DE</i> 2 DF (240x115x113) hammer drilling	4/1,4	-	-	-	-	0,75	-	2,5	-	-
	2/1,4	-	-	-	-	0,4	-	1,2	-	-
	2/1,2	0,9	0,4 0,5 ²⁾	0,9 1,2 ²⁾	8)	0,75 0,9 ³⁾	0,4	8)	0,9 1,2 ²⁾	8)
Lightweight solid brick Vbl , acc. to EN 771-3:2011 e.g. <i>KLB DE</i> 8 DF (490x240x115) hammer drilling	12/1,8	2,5	-	-	-	-	-	3,0 4,5 ³⁾	-	-
	10/1,8	2,5	-	-	-	-	-	2,5 3,5 ³⁾	-	-
	8/1,8	2,5	-	-	-	-	-	2,0 3,0 ³⁾	-	-
	8/1,6	-	-	-	-	3,0	-	-	-	-
	6/1,8	2,0	-	-	-	-	-	1,5 2,0 ³⁾	-	-
	6/1,6	-	-	-	-	2,0	-	-	-	-
	4/1,8	1,2	-	-	-	-	-	0,9 1,5 ³⁾	-	-
	2/1,2	-	-	-	-	1,2	-	-	-	-
	2/1,0	1,2	-	-	-	-	-	-	-	-
Partial safety factor	γ_{Mm} ¹⁾	2,5								

1) In absence of other national regulations.

2) Only valid for temperature range 30/50° C.

3) Only valid for edge distance $c \geq 150$ mm; intermediate values by linear interpolation.

4) Only valid for edge distance $c \geq 200$ mm; intermediate values by linear interpolation.

5) Only valid for edge distance $c \geq 150$ mm for temperature range 30/50° C; intermediate values by linear interpolation.

6) Only valid for edge distance $c \geq 200$ mm for temperature range 30/50° C; intermediate values by linear interpolation.

8) Values of lower h_{nom} can also be taken for next higher h_{nom} .

fischer frame fixing SXR / SXRL

Performances
Characteristic resistance for use in solid masonry

Annex C 5

Table C6.1: Characteristic resistance F_{Rk} in [kN] in solid masonry (use category “b”)

Base material [Supplier Title] Geometry, DF or nom. size (L x W x H) [mm] and drilling method	Min. com- pressive strength f_b [N/mm ²] / bulk density ρ [kg/dm ³]	Characteristic resistance F_{Rk} [kN] 50/80°C									
		SXR 8	SXRL 8			SXR 10	SXRL 10		SXRL 14		
		h_{nom} [mm]									
		≥ 50	≥ 50	≥ 70	≥ 90	≥ 50	≥ 50	≥ 70	≥ 70	≥ 90	
Lightweight solid brick Vbl , acc. to EN 771-3:2011 e.g. <i>KLB DE</i> 8 DF (245x240x240) hammer drilling	10/1,6	-	2,0 2,5 ²⁾	3,0 4,0 ⁵⁾	8)	2,5	3,0 3,5 ⁵⁾	7,5	3,5 6,0 ⁴⁾ 7,0 ⁶⁾	8)	
	8/1,6	-	1,5 2,0 ²⁾	2,5 3,5 ⁵⁾	8)	2,5	2,5 3,0 ⁵⁾	6,0	3,0 5,0 ⁴⁾ 6,0 ⁶⁾	8)	
	6/1,6	-	1,2 1,5 ²⁾	2,0 2,5 ⁵⁾	8)	2,5	2,0	4,5	2,0 3,5 ⁴⁾ 4,5 ⁶⁾	8)	
	6/1,4	0,9	-	-	-	-	-	-	-	-	
	4/1,6	-	0,75 0,9 ²⁾	1,2 1,5 ⁵⁾	8)	0,9	1,2 1,5 ⁵⁾	3,0	1,5 2,5 ⁴⁾ 3,0 ⁶⁾	8)	
	4/1,4	0,6 0,75 ²⁾	-	-	-	-	-	-	-	-	
	2/1,6	-	0,4 0,5 ²⁾	0,6 0,9 ⁵⁾	8)	0,5	0,6	1,5	-	-	
Lightweight solid brick Vbl , acc. to EN 771-3:2011, e.g. <i>Liapor Super-K DE</i> 16 DF (500x240x248) hammer drilling	2/0,8	-	-	-	-	-	-	0,5	-	-	
Lightweight solid brick Vbl , acc. to EN 771-3:2011, e.g. <i>Tarmac UK</i> (440x100x215) hammer drilling	6/1,4	-	-	-	-	2,0 2,5 ⁴⁾	-	2,0 3,0 ³⁾	-	-	
	4/1,4	-	-	-	-	1,2 1,5 ⁴⁾	-	1,2 2,0 ³⁾	-	-	
Partial safety factor	γ_{Mm} ¹⁾	2,5									

1) In absence of other national regulations.

2) Only valid for temperature range 30/50° C.

3) Only valid for edge distance $c \geq 150$ mm; intermediate values by linear interpolation.

4) Only valid for edge distance $c \geq 200$ mm; intermediate values by linear interpolation.

5) Only valid for edge distance $c \geq 150$ mm for temperature range 30/50° C; intermediate values by linear interpolation.

6) Only valid for edge distance $c \geq 200$ mm for temperature range 30/50° C; intermediate values by linear interpolation.

8) Values of lower h_{nom} can also be taken for next higher h_{nom} .

fischer frame fixing SXR / SXRL

Performances
Characteristic resistance for use in solid masonry

Annex C 6

Table C7.1: Characteristic resistance F_{Rk} in [kN] in solid masonry (use category “b”)

Base material [Supplier Title] Geometry, DF or nom. size (L x W x H) [mm] and drilling method	Min. com- pressive strength f_b [N/mm ²] / bulk density ρ [kg/dm ³]	Characteristic resistance F_{Rk} [kN] 50/80°C								
		SXR 8	SXRL 8		SXR 10	SXRL 10		SXRL 14		
		h_{nom} [mm]								
		≥ 50	≥ 50	≥ 70	≥ 90	≥ 50	≥ 50	≥ 70	≥ 70	≥ 90
Solid brick normal concrete Vbn , acc. to EN 771-3:2011 <i>e.g. Adolf Blatt DE</i> (240x245x240) hammer drilling	20/1,8	2,5	-	-	-	4,5	-	-	-	-
	16/1,8	2,5	-	-	-	3,5	-	-	-	-
	12/1,8	2,5	-	-	-	3,0	-	-	-	-
	10/1,8	1,5	-	-	-	3,0	-	-	-	-
	8/1,8	1,5	-	-	-	-	-	-	-	-
	4/1,8	0,75	-	-	-	-	-	-	-	-
Solid brick normal concrete Vbn , acc. to EN 771-3:2011 <i>e.g. Tarmac UK</i> (440x100x215) hammer drilling	16/1,8	-	-	-	-	4,0 4,5 ²⁾	-	5,5	-	-
	10/1,8	-	-	-	-	2,5 3,0 ²⁾	-	3,5	-	-
Partial safety factor γ_{Mm} ¹⁾		2,5								

Footnotes see C7.2

Table C7.2: Characteristic resistance F_{Rk} in [kN] in hollow or perforated masonry (use category “c”)

Base material [Supplier Title] Geometry, DF or nom. size (L x W x H) [mm] and drilling method	Min. com- pressive strength f_b [N/mm ²] / bulk density ρ [kg/dm ³]	Characteristic resistance F_{Rk} [kN] 50/80°C								
		SXR 8	SXRL 8		SXR 10	SXRL 10		SXRL 14		
		h_{nom} [mm]								
		50	50	70	90	50	50	70	70	90
S1 Perforated clay brick HLz Form B, acc. to EN 771-1:2011 <i>e.g. Wienerberger</i>	20/1,2	1,2	-	-	-	2,5 3,0 ⁵⁾	-	2,0	-	-
	20/1,0	-	-	-	-	2,0	-	-	-	-
	12/1,2	-	-	-	-	-	-	1,2	-	-
	10/1,2	-	-	-	-	1,5 2,0 ²⁾	-	-	-	-
	10/1,0	-	-	-	-	1,2	-	-	-	-
2 DF (240x115x113) rotary drilling	8/1,2	0,5	-	-	-	-	-	-	-	-
Partial safety factor γ_{Mm} ¹⁾		2,5								

¹⁾ In absence of other national regulations.

²⁾ Only valid for temperature range 30/50° C.

⁵⁾ Only valid for edge distance $c \geq 150$ mm at temperature range 30/50° C; intermediate values by linear interpolation.



fischer frame fixing SXR / SXRL

Performances

Characteristic resistance for use in solid masonry and in hollow or perforated masonry

Annex C 7

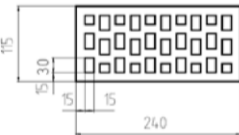
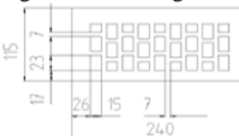
Table C8.1: Characteristic resistance F_{Rk} in [kN] in hollow or perforated masonry (use category “c”)

Base material [Supplier Title] Geometry, DF or nom. size (L x W x H) [mm] and drilling method	Min. compressive strength f_b [N/mm ²] / bulk density ρ [kg/dm ³]	Characteristic resistance F_{Rk} [kN] 50/80°C								
		SXR 8	SXRL 8 ⁷⁾			SXR 10	SXRL 10		SXRL 14 ⁷⁾	
		h_{nom} [mm]								
		50	50	70	90	50	50	70	70	90
S2 Perforated clay brick HLz acc. to EN 771-1:2011 e.g. Wienerberger 	28/1,2		1,2 1,5 ²⁾	1,5 2,0 ²⁾	1,5 2,0 ²⁾	-	-	2,0	-	-
	20/1,2		0,9 1,2 ²⁾	0,9 1,2 ²⁾	1,2 1,5 ²⁾	-	-	1,2	-	-
	12/1,0	0,6	-	-	-	0,9	-	0,75	-	-
	10/1,2	-	0,6	0,6 0,75 ²⁾	0,6 0,9 ²⁾	-	-	-	-	-
	10/1,0	-	-	-	-	0,75	-	0,6	-	-
	8/1,0	0,4	-	-	-	0,6	-	-	-	-
S3 Perforated clay brick VHLz acc. to EN 771-1:2011, e.g. Wienerberger 	48/1,6	-	-	-	-	-	-	4,5 5,0 ²⁾	4,5 5,0 ²⁾	
28/1,6	-	-	-	-	-	-	-	2,5 3,0 ²⁾	2,5 3,0 ²⁾	
20/1,6	-	-	-	-	-	-	-	1,5 2,0 ²⁾	1,5 2,0 ²⁾	
S4 Perforated clay brick VHLz acc. to EN 771-1:2011, e.g. Wienerberger 	48/1,6	-	2,5	2,5	1,5 2,0 ²⁾	2,5	-	4,5	-	-
36/1,6	-	2,0	2,0	1,2 1,5 ²⁾	2,0	-	-	3,0	-	-
28/1,6	-	1,5	1,5	0,9 1,2 ²⁾	1,5	-	-	2,5	-	-
20/1,6	-	0,9	0,9	0,6 0,9 ²⁾	0,9	-	-	1,5	-	-
12/1,6	-	0,6	0,6	0,4 0,5 ²⁾	0,6	-	-	0,9	-	-
10/1,6	-	-	-	-	-	-	-	0,9	-	-
Partial safety factor	γ_{Mm} ¹⁾	2,5								

1) In absence of other national regulations.

2) Only valid for temperature range 30/50° C.

3) Only valid for edge distance $c \geq 150$ mm; intermediate values by linear interpolation.

4) Only valid for edge distance $c \geq 200$ mm; intermediate values by linear interpolation.

5) Only valid for edge distance $c \geq 150$ mm at temperature range 30/50° C; intermediate values by linear interpolation.

6) Only valid for edge distance $c \geq 200$ mm at temperature range 30/50° C; intermediate values by linear interpolation.

7) The lowest load of two consecutive embedment depths may be used for the intermediate embedment depths.

fischer frame fixing SXR / SXRL

Performances

Characteristic resistance for use in hollow or perforated masonry

Annex C 8

Table C9.1: Characteristic resistance F_{Rk} in [kN] in hollow or perforated masonry (use category “c”)

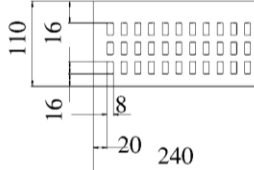
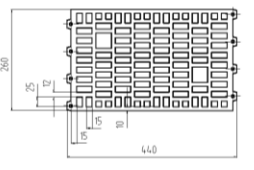
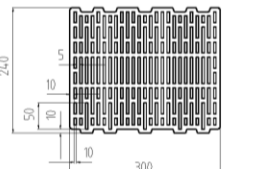
Base material [Supplier Title] Geometry, DF or nom. size (L x W x H) [mm] and drilling method	Min. compressive strength f_b [N/mm ²] / bulk density ρ [kg/dm ³]	Characteristic resistance F_{Rk} [kN] 50/80°C								
		SXR 8	SXRL 8		SXR 10	SXRL 10		SXRL 14		
		h _{nom} [mm]								
		50	50	70	90	50	50	70	70	90
S5 Perforated clay brick HLz acc. to EN 771-1:2011+A1:2014, <i>e.g. Wienerberger, BS</i>  DF(240x110x52) hammer drilling	28/1,5	2,5	-	-	-	2,5	-	-	-	-
	20/1,5	1,2 1,5 ²⁾	-	-	-	2,0	-	-	-	-
	10/1,5	0,6 0,9 ²⁾	-	-	-	1,2	-	-	-	-
S6 Perforated clay brick HLz Form B, acc. to EN 771-1:2011 <i>e.g. Schlagmann</i>  10 DF (260x240x440) rotary drilling	8/0,9	0,9	-	-	-	-	-	-	-	-
	6/0,9	0,6	-	-	-	-	-	-	-	-
	4/0,9	0,4	-	-	-	-	-	-	-	-
S7 Perforated clay brick HLz acc. to EN 771-1:2011 <i>e.g. Schlagmann Poroton T14</i>  10 DF (300x240x240) rotary drilling	6/0,7	-	-	-	-	0,3 0,4 ²⁾	-	0,5	-	-
Partial safety factor	γ_{Mm} ¹⁾	2,5								

1) In absence of other national regulations.

2) Only valid for temperature range 30/50° C.



fischer frame fixing SXR / SXRL

Performances

Characteristic resistance for use in hollow or perforated masonry

Annex C 9

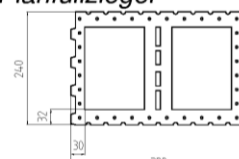
Table C10.1: Characteristic resistance F_{Rk} in [kN] in hollow or perforated masonry (use category “c”)

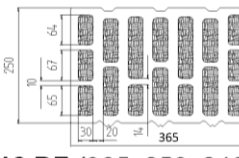
Base material [Supplier Title] Geometry, DF or nom. size (L x W x H) [mm] and drilling method	Min. compressive strength f_b [N/mm ²] / bulk density ρ [kg/dm ³]	Characteristic resistance F_{Rk} [kN] 50/80°C								
		SXR 8	SXRL 8		SXR 10	SXRL 10		SXRL 14		
		h_{nom} [mm]								
		50	50	70	90	50	50	70	70	90
S8 Perforated clay brick HLz Form B, acc. to EN 771-1:2011, e.g. <i>Schlagmann</i> <i>Planfüllziegel</i> 	6/0,7	1,2	-	-	-	2,0	-	-	-	-
	4/0,7	0,75	-	-	-	-	-	-	-	-
	2/0,7	0,4	-	-	-	-	-	-	-	-
12 DF (380x240x240) rotary drilling										
S9 Perforated clay brick HLz acc. to EN 771-1:2011 e.g. <i>Schlagmann</i> 	12/1,0	-	-	-	-	-	-	-	2,0	2,5
	10/1,0	-	-	-	-	-	-	-	2,0	2,0
	8/1,0	-	-	-	-	-	-	-	1,5	1,5
	6/1,0	-	-	-	-	-	-	-	1,2	1,2
3 DF (240x175x113) rotary drilling										
S10 Perforated clay brick HLz acc. to EN 771-1:2011, e.g. <i>Schlagmann</i> <i>Poroton S11</i> 	8/0,8	-	-	-	-	-	-	1,5	-	-
	6/0,8	-	-	-	-	-	-	1,2	-	-
	4/0,8	-	-	-	-	-	-	0,75	-	-
12 DF (365x250x240) rotary drilling										
Partial safety factor	γ_{Mm} ¹⁾	2,5								

¹⁾ In absence of other national regulations.

fischer frame fixing SXR / SXRL

Performances
Characteristic resistance for use in hollow or perforated masonry

Annex C 10

Table C11.1: Characteristic resistance F_{Rk} in [kN] in hollow or perforated masonry (use category “c”)

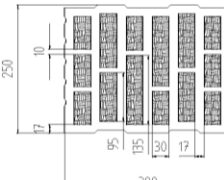
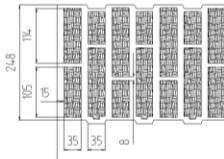
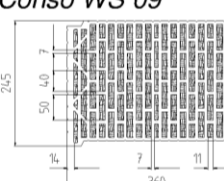
Base material [Supplier Title] Geometry, DF or nom. size (L x W x H) [mm] and drilling method	Min. compressive strength f_b [N/mm ²] / bulk density ρ [kg/dm ³]	Characteristic resistance F_{Rk} [kN] 50/80°C								
		SXR 8	SXRL 8		SXR 10	SXRL 10		SXRL 14		
		h_{nom} [mm]								
		50	50	70	90	50	50	70	70	90
S11 Perforated clay brick HLz acc. to EN 771-1:2011 e.g. <i>Schlagmann Poroton S10</i> 	6/0,7	-	-	-	-	-	-	1,5	-	-
	4/0,7	-	-	-	-	-	-	0,9	-	-
10 DF (300x250x240) rotary drilling										
S12 Perforated clay brick HLz acc. to EN 771-1:2011 e.g. <i>Schlagmann Poroton T8</i> 	4/0,6	-	-	-	-	-	-	1,2	-	-
	2/0,6	-	-	-	-	-	-	0,6	-	-
12 DF (365x248x240) rotary drilling										
S13 Perforated clay brick HLz acc. to EN 771-1:2011, e.g. <i>Hörl & Hartmann Coriso WS 09</i> 	6/0,8	-	-	-	-	-	-	0,9	-	-
	4/0,8	-	-	-	-	-	-	0,6	-	-
	2/0,8	-	-	-	-	-	-	0,3	-	-
(360x245x240) rotary drilling										
Partial safety factor	γ_{Mm} ¹⁾	2,5								

¹⁾ In absence of other national regulations.

fischer frame fixing SXR / SXRL

Annex C 11

Performances
Characteristic resistance for use in hollow or perforated masonry

Table C12.1: Characteristic resistance F_{Rk} in [kN] in hollow or perforated masonry (use category "c")

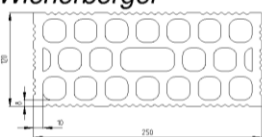
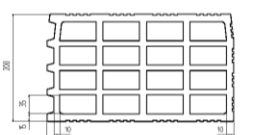
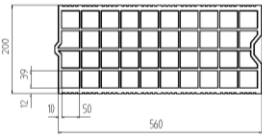
Base material [Supplier Title] Geometry, DF or nom. size (L x W x H) [mm] and drilling method	Min. com- pressive strength f_b [N/mm ²] / bulk density ρ [kg/dm ³]	Characteristic resistance F_{Rk} [kN] 50/80°C								
		SXR 8	SXRL 8 ⁷⁾		SXR 10	SXRL 10		SXRL 14 ⁷⁾		
		h _{nom} [mm]								
		50	50	70	90	50	50	70	70	90
S14 Perforated clay brick HLz acc. to EN 771-1:2011 e.g. <i>Doppio Uni IT</i> <i>Wienerberger</i>  (250x120x190) rotary drilling	20/0,9	-	1,2	0,9 1,5 ²⁾	1,5 2,0 ²⁾	-	-	-	-	-
	16/0,9	-	0,9	0,9 1,2 ²⁾	1,2 1,5 ²⁾	-	-	-	-	-
	12/0,9	-	0,75	0,6 0,75 ²⁾	0,9 1,2 ²⁾	-	-	-	-	-
S15 Perforated clay brick HLz acc. to EN 771-1:2011, e.g. <i>Imerys Gelimatic</i>  (500x200x270) rotary drilling	6/0,6	-	-	-	-	0,6 0,75 ⁶⁾	-	1,5	-	-
	4/0,6	-	-	-	-	-	-	0,9	-	-
	2/0,6	-	-	-	-	-	-	0,5	-	-
S16 Perforated clay brick HLz acc. to EN 771-1:2011, e.g. <i>Imerys Optibric</i>  (560x200x275) rotary drilling	10/0,6	-	-	-	-	1,2	-	1,5	-	-
	8/0,6	-	-	-	-	-	-	1,2	-	-
	6/0,6	-	-	-	-	-	-	0,9	-	-
	4/0,6	-	-	-	-	-	-	0,6	-	-
Partial safety factor	γ_{Mm} ¹⁾	2,5								

1) In absence of other national regulations.

2) Only valid for temperature range 30/50° C.

6) Only valid for edge distance $c \geq 200$ mm for temperature range 30/50° C; intermediate values by linear interpolation.

7) The lowest load of two consecutive embedment depths may be used for the intermediate embedment depths.

fischer frame fixing SXR / SXRL

Performances
Characteristic resistance for use in hollow or perforated masonry

Annex C 12

Table C13.1: Characteristic resistance F_{Rk} in [kN] in hollow or perforated masonry (use category “c”)

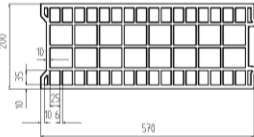
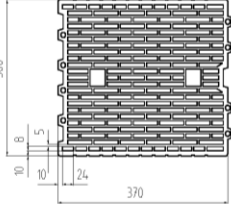
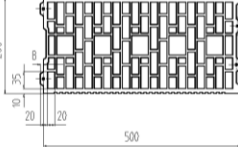
Base material [Supplier Title] Geometry, DF or nom. size (L x W x H) [mm] and drilling method	Min. compressive strength f_b [N/mm ²] / bulk density ρ [kg/dm ³]	Characteristic resistance F_{Rk} [kN] 50/80°C								
		SXR 8	SXRL 8		SXR 10	SXRL 10		SXRL 14		
		h _{nom} [mm]								
		50	50	70	90	50	50	70	70	90
S17 Perforated clay brick HLz acc. to EN 771-1:2011, e.g. <i>Bouyer Leroux BGV</i> (570x200x315)  rotary drilling	6/0,6	-	-	-	-	0,75 0,9 ³⁾ 1,2 ⁵⁾	-	0,9	-	-
S18 Perforated clay brick HLz acc. to EN 771-1:2011, e.g. <i>Wienerberger</i> <i>Porotherm 30 R</i>  (370x300x250) rotary drilling	10/0,7	-	-	-	-	0,5 0,6 ³⁾	-	-	-	-
S19 Perforated clay brick HLz acc. to EN 771-1:2011, e.g. <i>Wienerberger</i> <i>Porotherm GF R20</i>  (500x200x275) rotary drilling	10/0,7	-	-	-	-	0,6 0,75 ³⁾	-	0,9	-	-
Partial safety factor γ_{Mm} ¹⁾		2,5								

1) In absence of other national regulations.

3) Only valid for edge distance $c \geq 150$ mm; intermediate values by linear interpolation.

5) Only valid for edge distance $c \geq 150$ mm for temperature range 30/50 °C; intermediate values by linear interpolation.

7) The lowest load of two consecutive embedment depths may be used for the intermediate embedment depths.

fischer frame fixing SXR / SXRL

Performances
 Characteristic resistance for use in hollow or perforated masonry

Annex C 13

Table C14.1: Characteristic resistance F_{Rk} in [kN] in hollow or perforated masonry (use category “c”)

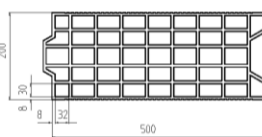
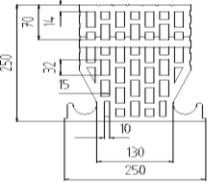
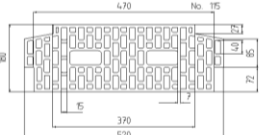
Base material [Supplier Title] Geometry, DF or nom. size (L x W x H) [mm] and drilling method	Min. com- pressive strength f_b [N/mm ²] / bulk density ρ [kg/dm ³]	Characteristic resistance F_{Rk} [kN] 50/80°C									
		SXR 8	SXRL 8				SXR 10	SXRL 10		SXRL 14	
		h_{nom} [mm]									
		50	50	70	90	50	50	70	70	90	
S20 Perforated clay brick HLz acc. to EN 771-1:2011, e.g. <i>Terreal Calibric</i>  (500x200x220) rotary drilling	8/0,7	-	-	-	-	0,6 0,75 ⁶⁾	-	0,9	-	-	
	6/0,7	-	-	-	-	-	-	0,75	-	-	
	4/0,7	-	-	-	-	-	-	0,4	-	-	
Perforated clay ceiling brick acc. to DIN 4159:2014-05, e.g. Hörl & Hartmann ceiling block  (250x250x190) rotary drilling	10/0,7	-	-	-	-	-	-	2,0	-	-	
	8/0,7	-	-	-	-	-	-	1,5	-	-	
	6/0,7	-	-	-	-	-	-	1,2	-	-	
Perforated clay ceiling brick acc. to EN 15037-3:2011, e.g. Hörl & Hartmann block for beam-and-block ceilings  (520x250x180) rotary drilling	8/0,7	-	-	-	-	-	-	1,5	-	-	
	6/0,7	-	-	-	-	-	-	1,2	-	-	
	4/0,7	-	-	-	-	-	-	0,9	-	-	
Partial safety factor	γ_{Mm} ¹⁾	2,5									

1) In absence of other national regulations.

6) Only valid for edge distance $c \geq 200$ mm for temperature range 30/50° C; intermediate values by linear interpolation.

fischer frame fixing SXR / SXRL

Performances

Characteristic resistance for use in hollow or perforated masonry

Annex C 14

Table C15.1: Characteristic resistance F_{Rk} in [kN] in hollow or perforated masonry (use category “c”)

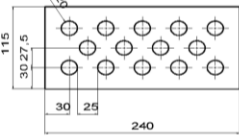
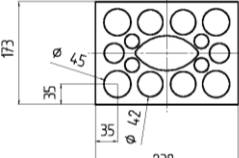
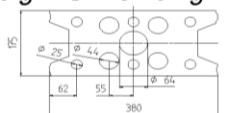
Base material [Supplier Title] Geometry, DF or nom. size (L x W x H) [mm] and drilling method	Min. com- pressive strength f_b [N/mm ²] / bulk density ρ [kg/dm ³]	Characteristic resistance F_{Rk} [kN] 50/80°C								
		SXR 8	SXRL 8 ⁷⁾			SXR 10	SXRL 10		SXRL 14 ⁷⁾	
		h _{nom} [mm]								
		50	50	70	90	50	50	70	70	90
S23 Hollow calcium silicate brick KSL acc. to EN 771-2:2011 e.g. KS Wemding  2 DF (240x115x113) hammer drilling	20/1,4	-	2,0	2,5	2,5	-	-	-	-	-
	12/1,4	2,0	1,2	1,5	1,5	2,0 2,5 ²⁾	-	2,5	1,5 2,0 ²⁾	2,5
	10/1,4	1,5	-	-	-	2,0	-	2,0	1,5	2,0
	8/1,4	1,2	-	-	-	1,5	-	1,5	1,2	1,5
	6/1,4	0,9	-	-	-	-	-	-	0,9	1,2
S24 Hollow calcium silicate brick KSL acc. to EN 771-2:2011 e.g. KS Wemding  3 DF (240x175x113) hammer drilling	20/1,4	1,2 1,5 ²⁾	-	-	-	-	-	-	-	-
	16/1,4	0,9 1,2 ²⁾	-	-	-	-	-	2,0	-	-
	12/1,4	0,75 0,9 ²⁾	-	-	-	-	-	1,5	-	-
	10/1,4	0,6 0,75 ²⁾	-	-	-	-	-	1,2	-	-
	8/1,4	0,5 0,6 ²⁾	-	-	-	-	-	1,0	-	-
6/1,4	-	-	-	-	-	-	0,75	-	-	
S25 Hollow calcium silicate brick KSL acc. to EN 771-2:2011 e.g. KS Wemding  9 DF (380x175x240) hammer drilling	20/1,4	-	0,6 0,75 ²⁾	1,5 2,0 ²⁾	0,9 1,2 ²⁾	-	-	3,5	3,5 4,0 ²⁾	1,5 2,0 ²⁾
	12/1,4	-	0,4 0,5 ²⁾	0,9 1,2 ²⁾	0,5 0,75 ²⁾	-	-	2,0	2,0 2,5 ²⁾	0,9 1,2 ²⁾
	10/1,4	-	-	-	-	-	-	2,0	1,5 2,0 ²⁾	0,75 0,9 ²⁾
Partial safety factor	γ_{Mm} ¹⁾	2,5								

1) In absence of other national regulations.

2) Only valid for temperature range 30/50° C.

7) The lowest load of two consecutive embedment depths may be used for the intermediate embedment depths.

fischer frame fixing SXR / SXRL

Performances

Characteristic resistance for use in hollow or perforated masonry

Annex C 15

Table C16.1: Characteristic resistance F_{Rk} in [kN] in hollow or perforated masonry (use category “c”)

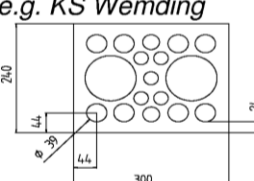
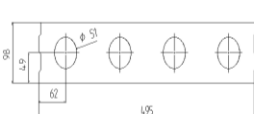
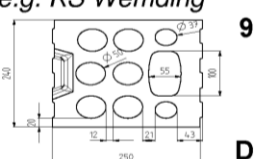
Base material [Supplier Title] Geometry, DF or nom. size (L x W x H) [mm] and drilling method	Min. compressive strength f_b [N/mm ²] / bulk density ρ [kg/dm ³]	Characteristic resistance F_{Rk} [kN] 50/80°C								
		SXR 8	SXRL 8		SXR 10	SXRL 10		SXRL 14		
		h_{nom} [mm]								
		50	50	70	90	50	50	70	70	90
S26 Hollow calcium silicate brick KSL acc. to EN 771-2:2011 e.g. <i>KS Wemding</i>  5 DF (300x240x113) hammer drilling	16/1,4	2,0	-	-	-	3,0 3,5 ⁵⁾	-	-	-	-
	12/1,4	1,5	-	-	-	-	-	-	-	-
	10/1,4	1,2	-	-	-	1,5	-	-	-	-
	8/1,4	0,9	-	-	-	-	-	-	-	-
	6/1,4	0,75 0,9 ²⁾	-	-	-	-	-	-	-	-
S27 Hollow calcium silicate brick KSL acc. to EN 771-2:2011 e.g. <i>KS Wemding, P10</i>  (495x98x245) hammer drilling	6/1,2	1,2 1,5 ²⁾	-	-	-	1,5 2,0 ³⁾ 2,5 ⁵⁾	-	-	-	-
	4/1,2	0,75 0,9 ²⁾	-	-	-	-	-	-	-	-
	2/1,2	0,4 0,5 ²⁾	-	-	-	-	-	-	-	-
S28 Hollow calcium silicate brick KSL acc. to EN 771-2:2011 e.g. <i>KS Wemding</i>  9 DF (250x240x240) hammer drilling	12/1,4	-	-	-	-	-	-	2,0	-	-
	10/1,4	-	-	-	-	-	-	1,5	-	-
	8/1,4	-	-	-	-	-	-	1,2	-	-
	6/1,4	-	-	-	-	-	-	0,9	-	-
Partial safety factor	γ_{Mm} ¹⁾	2,5								

1) In absence of other national regulations.

2) Only valid for temperature range 30/50° C.

3) Only valid for edge distance $c \geq 150$ mm; intermediate values by linear interpolation.

5) Only valid for edge distance $c \geq 150$ mm for temperature range 30/50° C; intermediate values by linear interpolation.

fischer frame fixing SXR / SXRL

Performances

Characteristic resistance for use in hollow or perforated masonry

Annex C 16

Table C17.1: Characteristic resistance F_{Rk} in [kN] in hollow or perforated masonry (use category “c”)

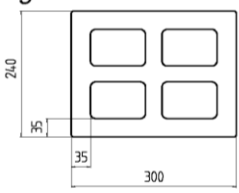
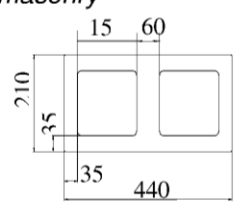
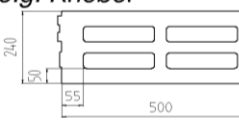
Base material [Supplier Title] Geometry, DF or nom. size (L x W x H) [mm] and drilling method	Min. compressive strength f_b [N/mm ²] / bulk density ρ [kg/dm ³]	Characteristic resistance F_{Rk} [kN] 50/80°C								
		SXR 8	SXRL 8 ⁷⁾			SXR 10	SXRL 10		SXRL 14 ⁷⁾	
		h _{nom} [mm]								
		50	50	70	90	50	50	70	70	90
S29 Hollow brick light-weight concrete Hbl acc. to EN 771-3, e.g. <i>KLB</i>  (300x240x240) hammer drilling	2/1,2	-	-	-	-	1,5	-	-	-	-
S30 Hollow brick light-weight concrete Hbl acc. to EN 771-3, e.g. <i>Roadstone masonry</i>  (440x210x215) hammer drilling	10/1,2	2,5	2,0	2,0 2,5 ²⁾	0,4 0,6 ²⁾	-	-	2,5	3,0	-
	8/1,2	2,0	1,5	1,5 2,0 ²⁾	0,3 0,5 ²⁾	2,5	-	2,0	2,5	-
	6/1,2	1,5	1,2	1,2 1,5 ²⁾	0,3	2,0	-	1,5	2,0	-
	4/1,2	-	-	-	-	-	-	0,9	1,2	-
	2/1,2	-	-	-	-	-	-	0,5	0,6	-
S31 Hollow brick light-weight concrete Hbl acc. to EN 771-3, e.g. <i>Knobel</i>  (500x240x240) rotary drilling	6/0,8	-	1,5	2,5	1,5 2,0 ²⁾	-	2,5	-	-	-
	4/0,8	-	0,9	1,5	0,9 1,2 ²⁾	-	1,5	-	-	-
	2/0,8	-	0,5	0,75	0,5 0,6 ²⁾	-	0,75	-	-	-
	2/0,7	-	1,5 2,0 ²⁾	2,0 2,5 ²⁾	1,5 2,0 ²⁾	-	2,0 2,5 ²⁾	2,5	1,2 1,5 ²⁾	0,75
Partial safety factor	γ_{Mm} ¹⁾	2,5								

1) In absence of other national regulations.

2) Only valid for temperature range 30/50° C.

7) The lowest load of two consecutive embedment depths may be used for the intermediate embedment depths.

fischer frame fixing SXR / SXRL

Performances

Characteristic resistance for use in hollow or perforated masonry

Annex C 17

Table C18.1: Characteristic resistance F_{Rk} in [kN] in hollow or perforated masonry (use category “c”)

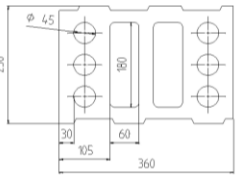
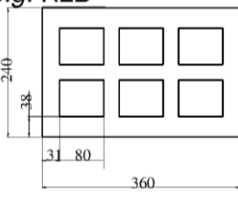
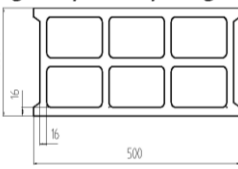
Base material [Supplier Title] Geometry, DF or nom. size (L x W x H) [mm] and drilling method	Min. compressive strength f_b [N/mm ²] / bulk density ρ [kg/dm ³]	Characteristic resistance F_{Rk} [kN] 50/80°C									
		SXR 8	SXRL 8		SXR 10	SXRL 10		SXRL 14			
		h _{nom} [mm]									
		50	50	70	90	50	50	70	70	90	
S32 Hollow brick light-weight concrete Hbl acc. to EN 771-3, <i>e.g. KLB</i>  (360x250x250) hammer drilling	2/0,9	-	-	-	-	-	-	0,75	-	-	
S33 Hollow brick light-weight concrete Hbl acc. to EN 771-3:2011, <i>e.g. KLB</i>  (360x240x240) hammer drilling	6/1,0	1,5	-	-	-	-	-	-	-	-	
S34 Hollow brick light-weight concrete Hbl acc. to EN 771-3:2011, <i>e.g. Sepa Parpaing</i>  (500x200x200) rotary drilling	6/0,9	-	-	-	-	-	-	0,5	-	-	
	4/0,9	0,3 0,4 ²⁾	-	-	-	0,9 1,2 ⁴⁾ 1,5 ⁶⁾	-	0,3	-	-	
Partial safety factor	γ_{Mm} ¹⁾	2,5									

1) In absence of other national regulations.

2) Only valid for temperature range 30/50° C.

4) Only valid for edge distance $c \geq 200$ mm; intermediate values by linear interpolation.

6) Only valid for edge distance $c \geq 200$ mm for temperature range 30/50° C; intermediate values by linear interpolation.

fischer frame fixing SXR / SXRL

Performances

Characteristic resistance for use in hollow or perforated masonry

Annex C 18

Table C19.1: Characteristic resistance F_{Rk} in [kN] in hollow or perforated masonry (use category “c”)

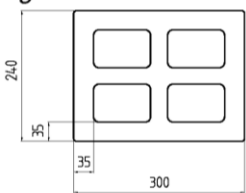
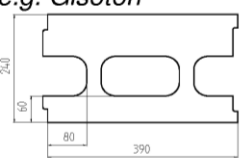
Base material [Supplier Title] Geometry, DF or nom. size (L x W x H) [mm] and drilling method	Min. com- pressive strength f_b [N/mm ²] / bulk density ρ [kg/dm ³]	Characteristic resistance F_{Rk} [kN] 50/80°C									
		SXR 8	SXRL 8		SXR 10	SXRL 10		SXRL 14			
		h_{nom} [mm]									
		50	50	70	90	50	50	70	70	90	
S35 Hollow brick normal concrete Hbn acc. to EN 771-3, <i>e.g. Adolf Blatt</i>  (300x240x240) hammer drilling	6/1,6	-	-	-	-	2,5	-	2,0	-	-	
	4/1,6	-	-	-	-	1,5	-	1,2	-	-	
	2/1,6	-	-	-	-	0,75	-	0,6	-	-	
S36 Heat insulation brick WDB <i>e.g. Gisoton</i>  (390x240x240) hammer drilling	2/0,7	-	-	-	-	1,5	-	-	-	-	
Partial safety factor	γ_{Mm} ¹⁾	2,5									

¹⁾ In absence of other national regulations.

fischer frame fixing SXR / SXRL

Performances

Characteristic resistance for use in hollow or perforated masonry

Annex C 19

Table C20.1: Characteristic resistance F_{Rk} in [kN] in autoclaved aerated concrete (AAC), use category "d"

Base material [Supplier Title] Geometry, DF or nom. size (L x W x H) [mm] and drilling method	Min. com- pressive strength f_b [N/mm ²]	Characteristic resistance F_{Rk} [kN] 50/80°C									
		SXR 8	SXRL 8		SXR 10	SXRL 10		SXRL 14			
		h_{nom} [mm]									
		≥ 50	≥ 50	≥ 70	≥ 90	≥ 50	≥ 70	≥ 90	≥ 70	≥ 90	
Autoclaved aerated concrete, AAC acc. to EN 771-4:2011 e.g. (500x120x300) e.g. (500x250x300) hammer drilling	≥ 6	-	-	1,5 3,0 ⁵⁾	2,0 3,0 ⁵⁾	0,75 0,9 ²⁾	2,0 2,5 ⁶⁾ 3,0 ⁴⁾	2,5 3,0 ⁶⁾ 4,0 ⁴⁾	4,0	5,0	
	≥ 4	-	-	0,9 1,5 ⁵⁾	1,2 1,5 ⁵⁾	0,75 0,9 ²⁾	1,2 1,5 ⁶⁾ 2,0 ⁴⁾	1,5 2,5 ⁴⁾	2,5	3,0	
	≥ 3	-	-	0,6 0,9 ⁵⁾	0,9 1,2 ⁵⁾	0,4 ³⁾ 0,5 ²⁾³⁾	0,9 1,2 ⁴⁾	0,9 1,2 ⁶⁾ 1,5 ⁴⁾	1,5	2,0	
	≥ 2	-	-	0,4	0,6	0,4 ³⁾ 0,5 ²⁾³⁾	0,5 0,75 ⁴⁾	0,6 0,9 ⁴⁾	0,9	1,2	
Partial safety factor γ_{MAAC} ¹⁾		2,0									

- 1) In absence of other national regulations.
- 2) Only valid for temperature range 30/50° C.
- 3) For the fixing in autoclaved aerated concrete with a nominal compressive strength $f_{ck} < 4$ N/mm² the hole is made by using the accompanying AAC hole punch in accordance with Table C20.2.
- 4) Values valid for member thickness $h_{min} \geq 175$ mm.
- 5) Only valid for edge distance $c \geq 120$ mm.
- 6) Only valid for edge distance $c \geq 180$ mm.

Table C20.2: Assignment AAC hole punch type – anchor type (length) only for AAC $f_b < 4$ N/mm² SXR 10

Hole punch only for SXR 10 $h_{nom} = 50$ mm in AAC $f_b < 4$ N/mm ²					Anchor type (length)
Type	a_1	a_2	b	l	
GBS 10 x 80	9	10	80	85	SXR 10 x 52 SXR 10 x 60 SXR 10 x 80
GBS 10 x 100				105	SXR 10 x 100
GBS 10 x 135			140	SXR 10 x 120	
GBS 10 x 160			90	165	SXR 10 x 140 SXR 10 x 160
GBS 10 x 185				190	SXR 10 x 180
GBS 10 x 230				235	SXR 10 x 200 SXR 10 x 230

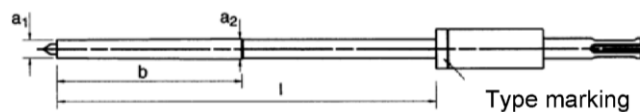

fischer frame fixing SXR / SXRL

Performances
Characteristic resistance for use in autoclaved aerated concrete

Annex C 20