

The Fibo logo is displayed in a dark blue square. The word "Fibo" is written in a light blue, sans-serif font. The letter "i" has a small red triangle above it.

Monteringsanvisning veggpanel - steg 1-5

Installation instruction wall panel - step 1-5



Installation in both
Norwegian and English

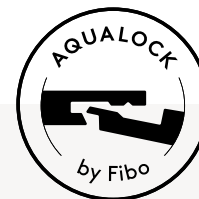

WALLS BUILT FOR LIFE

For å sikre holdbarhet på dine vegger i flere tiår, er Fibo veggpanel produsert med en kjerne av kryssfiner mellom balanselaminat i bakkant og et dekorativt høytrykkslaminat i front og som er enkelt å rengjøre og vedlikeholde. Fibo Aqualock gir enkel montering og et varig resultat.

To ensure that your walls are durable and will last for decades, Fibo wall panels are made from a plywood core layered between a balancing layer and a decorative high pressure laminate that is easy to clean and maintain. Fibo Aqualock makes the installation easy and provide a consistent result.

Inspirasjon og monteringsfilmer på **fibon.no**
Inspiration and installation videos at **fibosystem.com**
E-mail: **info@fibosystem.com**



FIBO MONTERINGSANVISNING

FIBO INSTALLATION INSTRUCTION

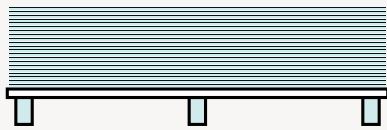

Lagring | Storage

Lagre panelene tørt og liggende i emballasjen frem til montering.

Keep panels dry stored and flat in package until installation.

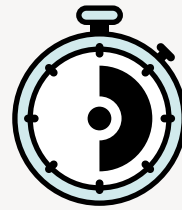

Min. 72 timer | Min. 72 hours

**Akklimatiser emballerte paneler i romtemperatur i minst 72 timer (mer hvis de har vært på kaldt lager).
Luftfuktigheten i rommet må være mer enn 30% både under og etter montering.**

Store panels in package in room conditions for at least 72 hour acclimatization (longer if they have been kept in a cold area). Humidity in the room must be above 30% during installation.

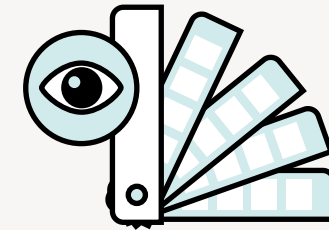

Visuell kontroll | Visual control

Kontroller farge og sjekk for andre feil før montering.

Colourmatch and check for flaws before installation



FIBO TILBEHØR

FIBO ACCESSORIES

1. Fibo Magic Sponge
2. Fibo Sealing Tools
3. Fibo Tapping Tool
4. Fibo Screws
5. Fibo Wipes
6. Fibo Clean
7. Fibo Seal (White, Grey, Black)
8. Fibo Grip



Vask bort rester fra
Fibo Wipes umiddelbart
med såpevann!
Remove residue from Fibo Wipes
immediatly with soap water!



FIBO TILBEHØR: ALU PROFILER
 FIBO ACCESSORIES: ALU PROFILES

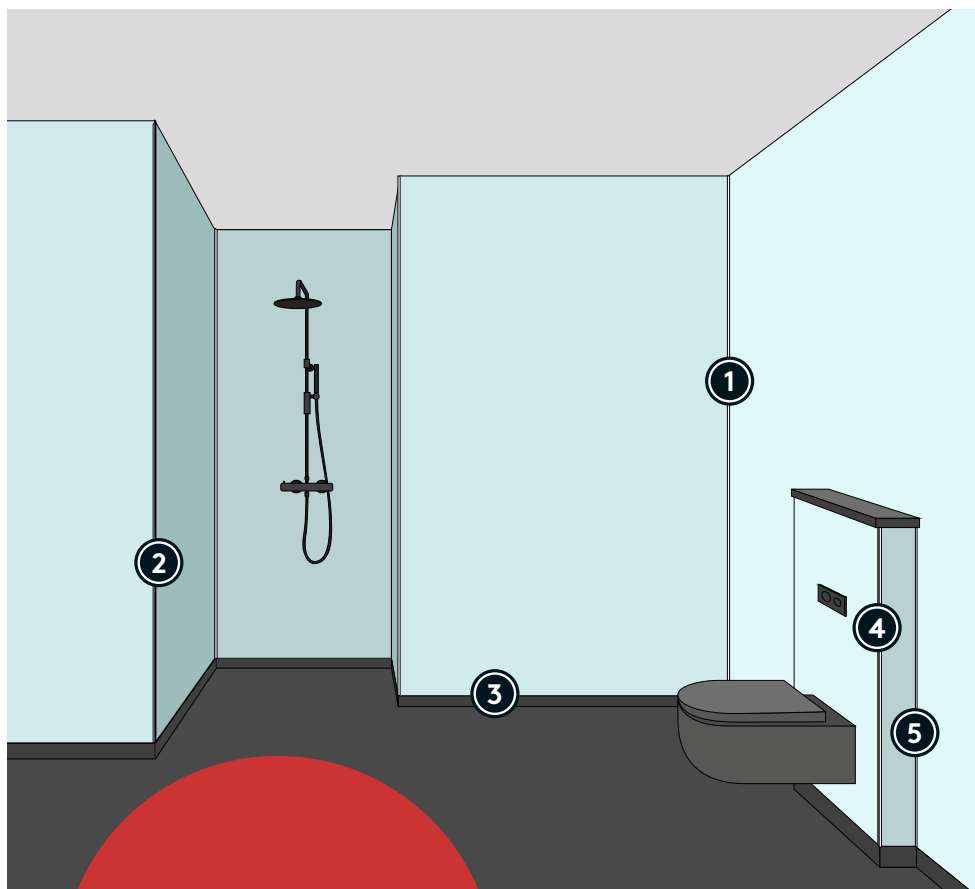

Fibo erstatter dampsperre på yttervegg når alle overganger er forseglet.
 Fibo replaces vapor barrier when all joints are sealed.

INTERNAL CORNER PROFILES			EXTERNAL CORNER
①			②
2-delt Innvendig Hjørneprofil 2-part Internal Corner profile	Skjult innvendig hjørneprofil Hidden Internal Corner profile	Standard Innvendig Hjørneprofil II Standard Internal Corner profile II	Utvendig hjørneprofil II External Corner profile II
BASE PROFILE		L-PROFILES	
③		④	
Sokkelprofil Base profile		L-profil II Smal L-profile II Small	
		L-profil II Bred L-profile II Wide	
			COMBI PROFILE
			⑤
			Kombiprofil Combi profile



VERKTØY DU TRENGER

TOOLS YOU NEED

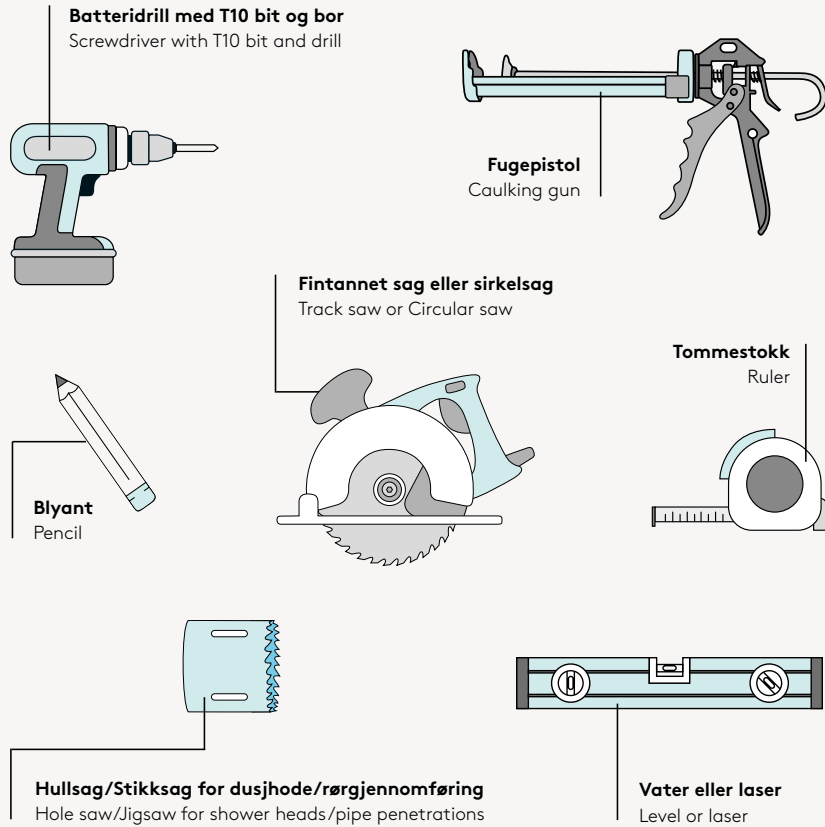

 **ADVARSEL: Verktøy må håndteres med forsiktighet for å unngå skade på paneler.**
WARNING: Power tools must be used with caution to prevent damaged panels.

TETTING AV SKRUEHULL

COVERING SCRE WHOLE

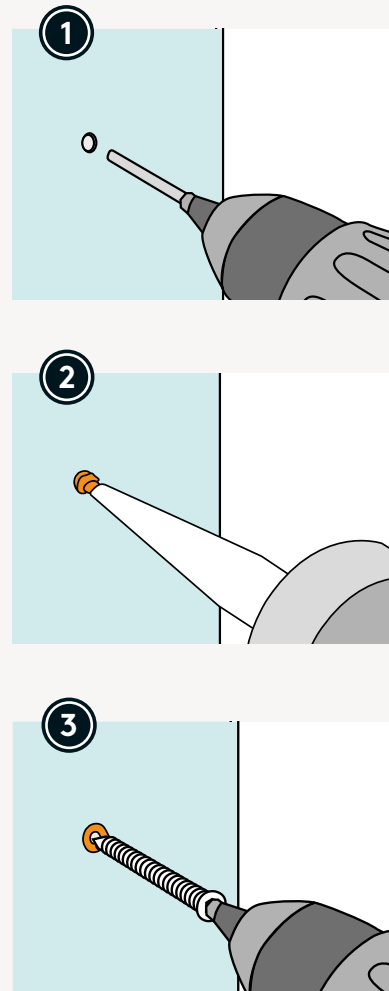

KUTTING AV PANEL

CUTTING PANELS





CLEANING & MAINTENANCE

RENGJØRING & VEDLIKEHOLD

RENGJØRING & VEDLIKEHOLD

Forleng fugemassens levetid ved korrekt rengjøring, i henhold til FDV på fibo.no. Spesielt fugemasse i sokkelprofil og skjult innvendig hjørne for fuging bør rengjøres regelmessig. Hvis fugemasse blir sprø eller skadet over tid, må den behandles umiddelbart.

Fuktet melaminsvamp (Fibo Sponge) kan brukes på særlig vanskelige flekker. Følg bruksanvisning på produktets emballasje.

CLEANING & MAINTENANCE

For watertight system, apply Fibo Seal as shown beneath. All cutting surfaces and bottom edge of panel must be sealed, also when drilling holes for pipe penetration. Incorrect installation will void your warranty. Use Fibo Clean and Fibo Wipes to remove excessive sealant. Film from cleaning accessories shall be removed immediately from panel surface.





HVORDAN FORSEGLE OG FUGE FIBO VEGGPANEL

HOW TO PRESEAL AND SEAL FIBO WALL PANELS

HVORDAN FORSEGLE OG FUGE FIBO VEGGPANEL

For vanntett system, påfør Fibo Seal som vist under. Alle kuttflater og kryssfiner i bunn av panel skal forsegles også ved hulltaking til rørgjennomføring. Ved mangelfull montering bortfaller garanti. Bruk Fibo Clean og Fibo Wipes for å fjerne overflødig fugemasse. Film fra rengjøringstilbehør skal fjernes umiddelbart fra panelene.

HOW TO PRESEAL AND SEAL FIBO WALL PANELS

For watertight system, apply Fibo Seal as shown beneath. All cutting surfaces and bottom edge of panel must be sealed, also when drilling holes for pipe penetration. Incorrect installation will void your warranty. Use Fibo Clean and Fibo Wipes to remove excessive sealant. Film from cleaning accessories shall be removed immediately from panel surface.

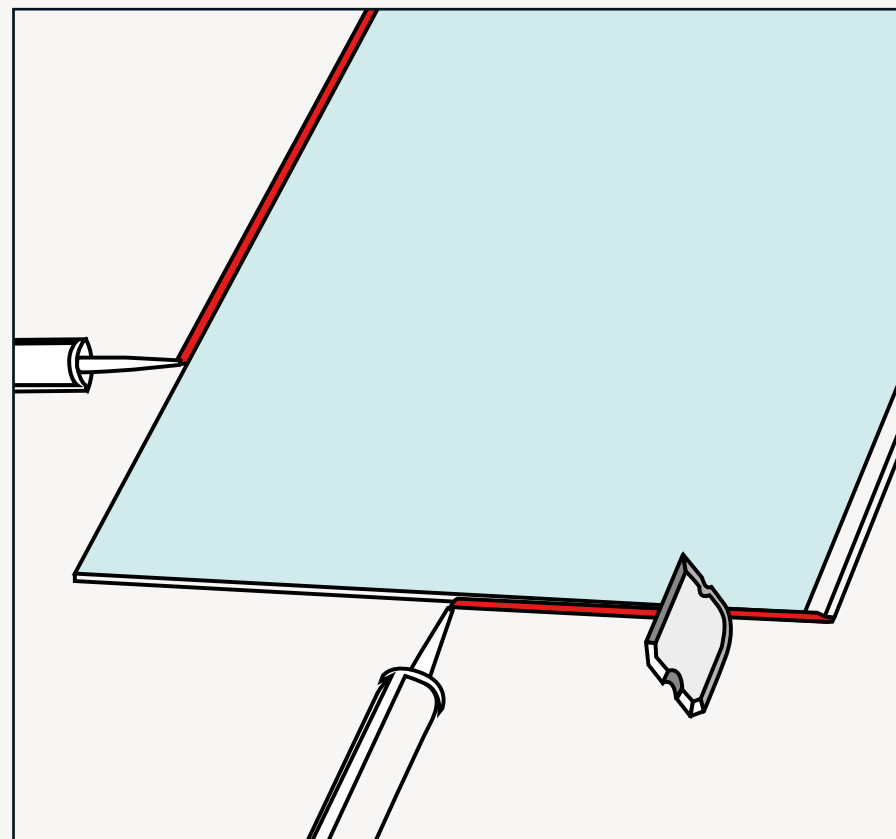

1A

VELG RIKTIG BAKVEGG BACKWALL OPTIONS

Benytt ekstra støtte i bakvegg dersom det skal monteres tunge gjenstander som skap, toalett, dusjsete, støttehåndtak eller lignende. Planhetstoleranse: Maksimalt planhetsavvik på +/-2 mm/2 meter. Det er ikke behov for dampsperre eller membran bak veggpanelene.

Extra support in backwall must be used if heavy objects such as cabinets, toilets, shower seats, support handles or similar is to be installed. Flatness tolerance: Maximum flatness deviation of +/-2 mm/2 meters. There is no need for extra membrane behind our wall panels.

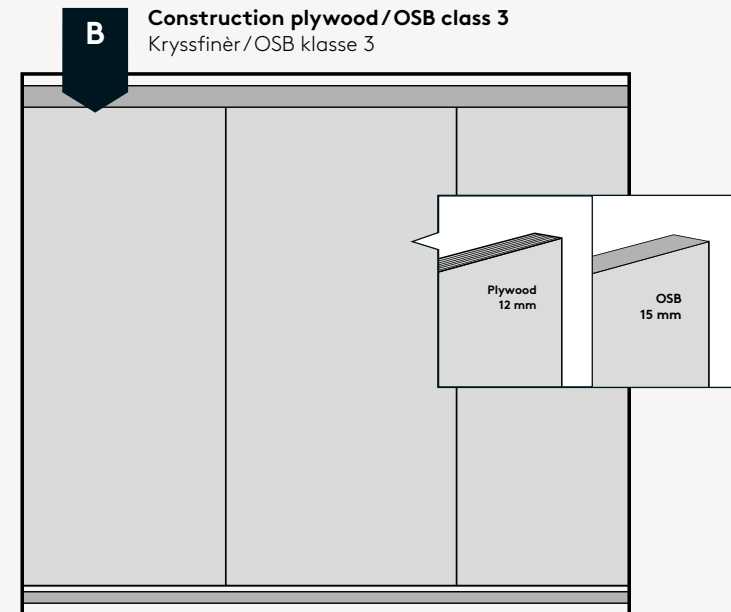
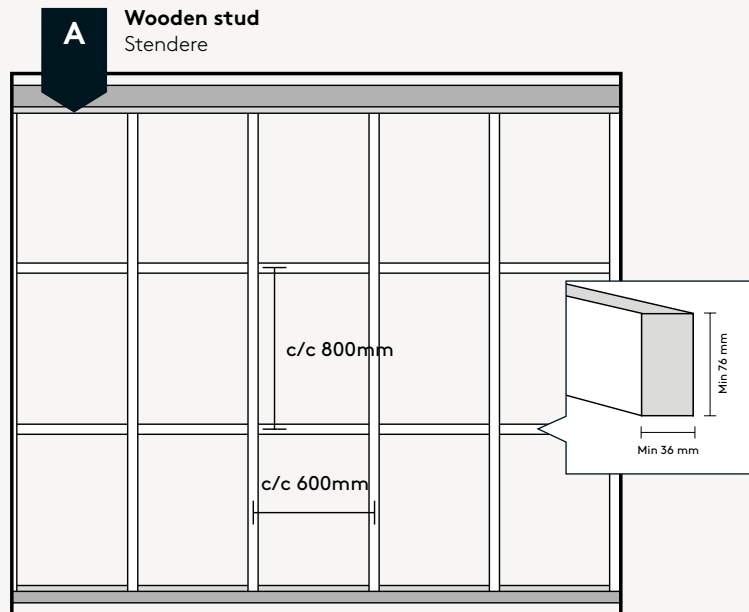

1B

VELG RIKTIG BAKVEGG BACKWALL OPTIONS

Benytt ekstra støtte i bakvegg dersom det skal monteres tunge gjenstander som skap, toalett, dusjsete, støttehåndtak eller lignende. Planhetstoleranse: Maksimalt planhetsavvik på +/- 2 mm/2 meter. Det er ikke behov for dampsperre eller membran bak veggpanelene.

Extra support in backwall must be used if heavy objects such as cabinets, toilets, shower seats, support handles or similar is to be installed. Flatness tolerance: Maximum flatness deviation of +/- 2 mm/2 meters. There is no need for extra membrane behind our wall panels.

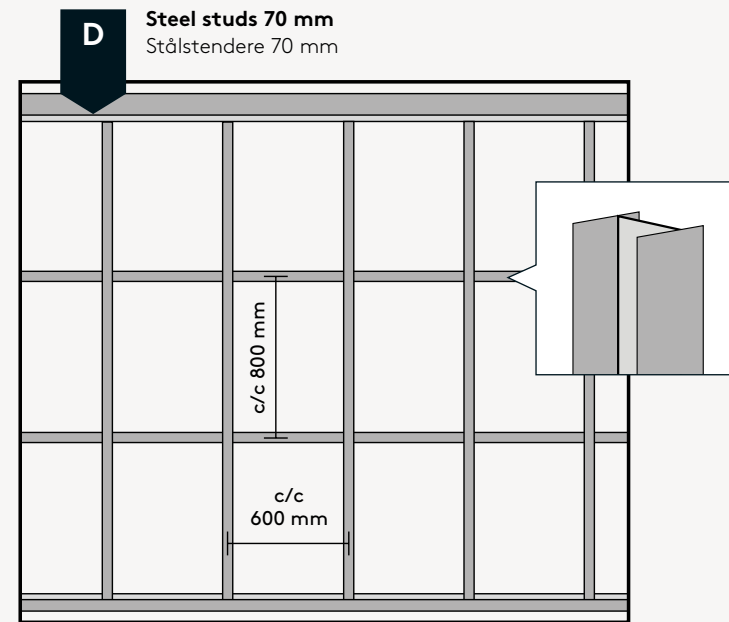
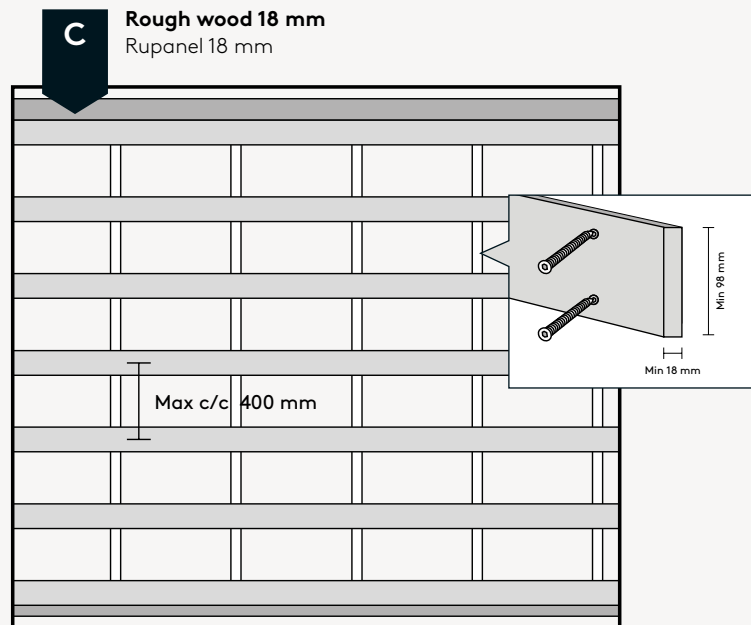

1C

VELG RIKTIG BAKVEGG BACKWALL OPTIONS

Benytt ekstra støtte i bakvegg dersom det skal monteres tunge gjenstander som skap, toalett, dusjsete, støttehåndtak eller lignende. Planhetstoleranse: Maksimalt planhetsavvik på +/- 2 mm/2 meter. Det er ikke behov for dampsperre eller membran bak veggpanelene.

Extra support in backwall must be used if heavy objects such as cabinets, toilets, shower seats, support handles or similar is to be installed. Flatness tolerance: Maximum flatness deviation of +/- 2 mm/2 meters. There is no need for extra membrane behind our wall panels.

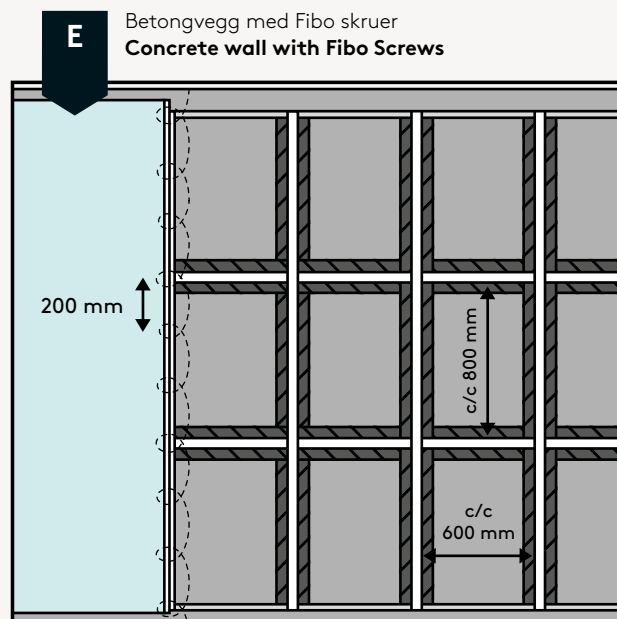

Ved montering på betong- eller teglvegger med skruer skal panelene festes til vertikale og horisontale lekter med dimensjoner min. 23 mm x 48 mm. Lektene skal monteres c/c 0,8 m med bred side mot vegg, med kapillært hindrende lag mellom de innerste lektene og betongveggen.

When installed on concrete or brick walls with screws, the panels shall be fixed to vertical and horizontal battens with dimensions min. 23 mm x 48 mm. The battens shall be installed c/c 0,8 m with the wide side flat, with a capillary obstructing layer between the inner battens and the concrete wall.

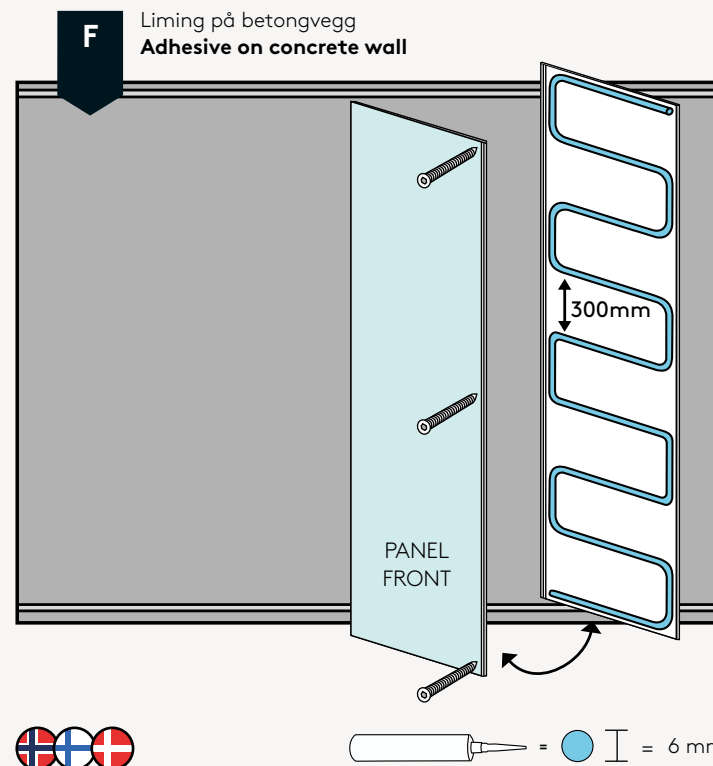

= = 6 mm

Fibo Seal in combination with screws, or glue with initial grab. Make sure to screw the first panel as shown.

Ved liming av panel til vegg av betong, sørg for at veggen er tørr (RH<85%/CM<2%), jevn og rengjort. Husk skruer på første panel - se figur.

2

ULIKE LØSNINGER FOR RØRGJENNOMFØRINGER DIFFERENT PIPE SOLUTIONS

Kuttflater skal forsegles ved hulltaking til rørgjennomføring. For fullstendig monteringsanvisning av EAD 030437-00-0503 godkjente løsninger, følg veggboksprodusentenes anvisninger. Godkjenning av PP- og kobberør er dokumentert i SINTEF Teknisk Godkjenning 2289.

Cutting surfaces must be sealed when drilling holes for pipe penetration. For complete installation guidance, follow the wall box producers' instructions. The ones illustrated are EAD 030437-00-0503 approved systems. Approval for PP- and copper pipes is documented through SINTEF Technical Approval 2289.

Første steg i alle tilfeller
First step in all cases

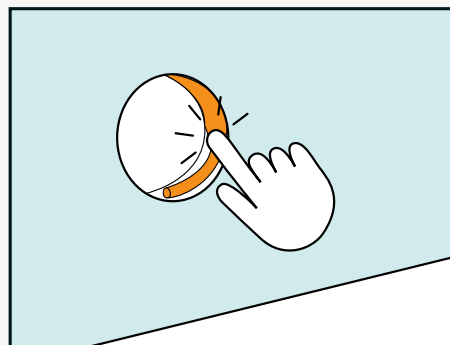

A Sanipex/Roth
Bruk av gjenget tetting

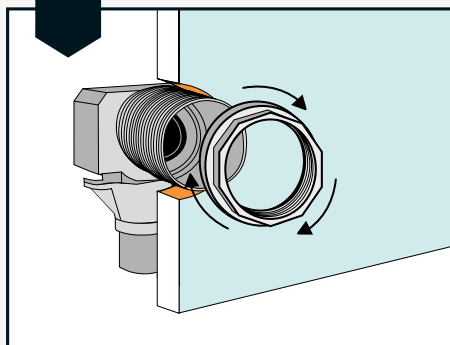

B PP- og PVC-rør, 110 mm
PP- and PVC pipes, 110 mm

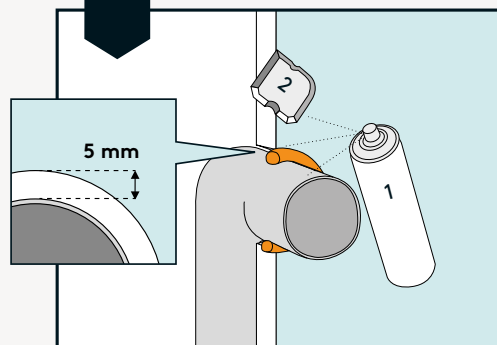

C Kobberør
Copper pipes

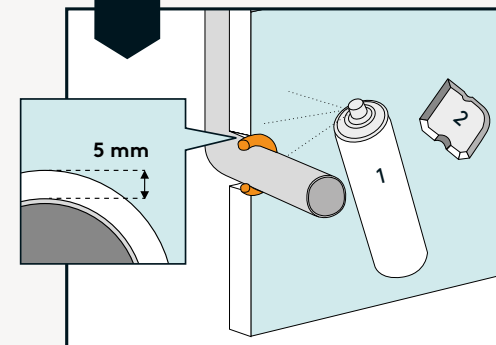

3

SKJØTEPROFIL | UTVENDIG HJØRNEPROFIL | AVSLUTNING MOT TAK STACKING PROFILE | EXTERNAL CORNER PROFILE | SEALING FINISH

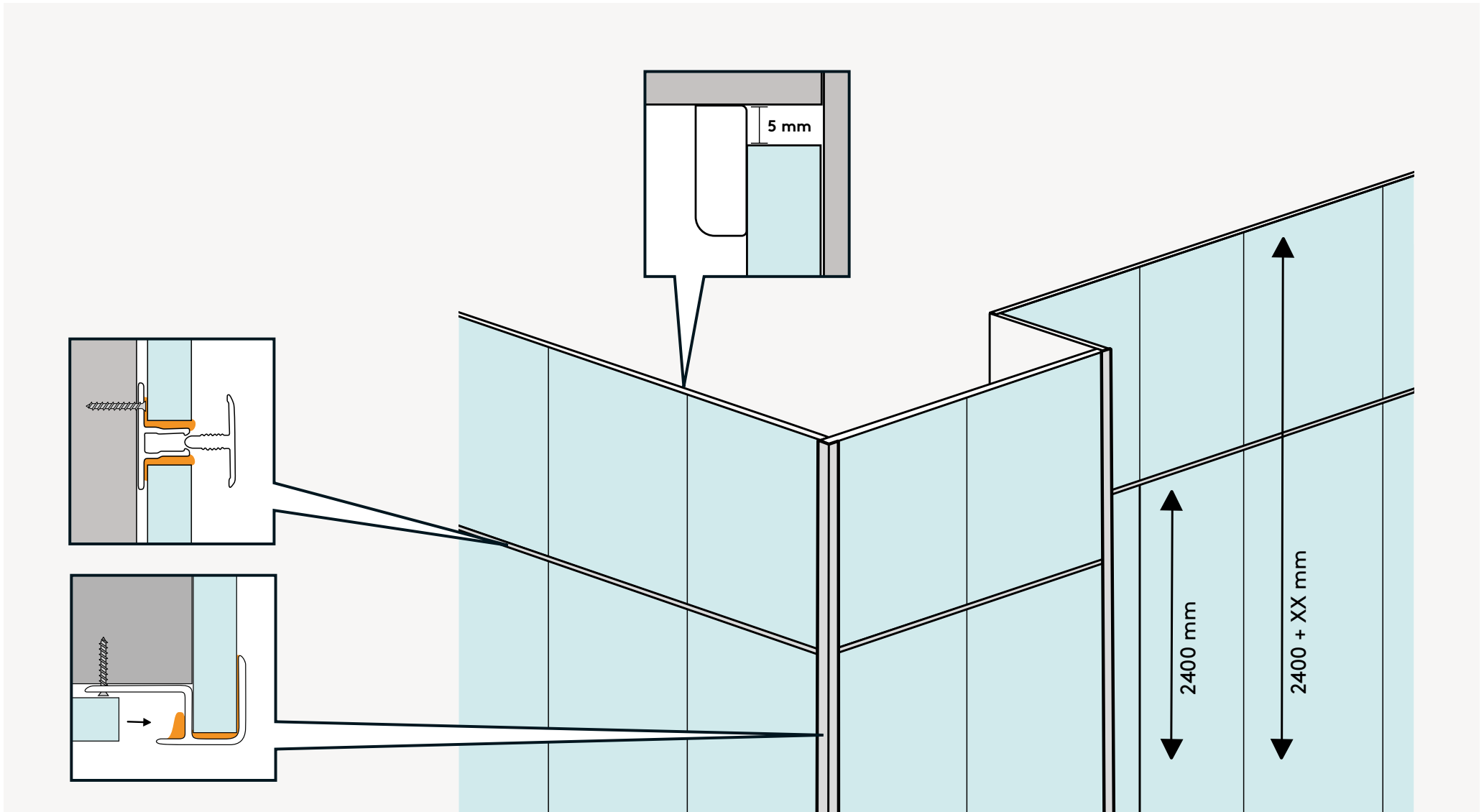

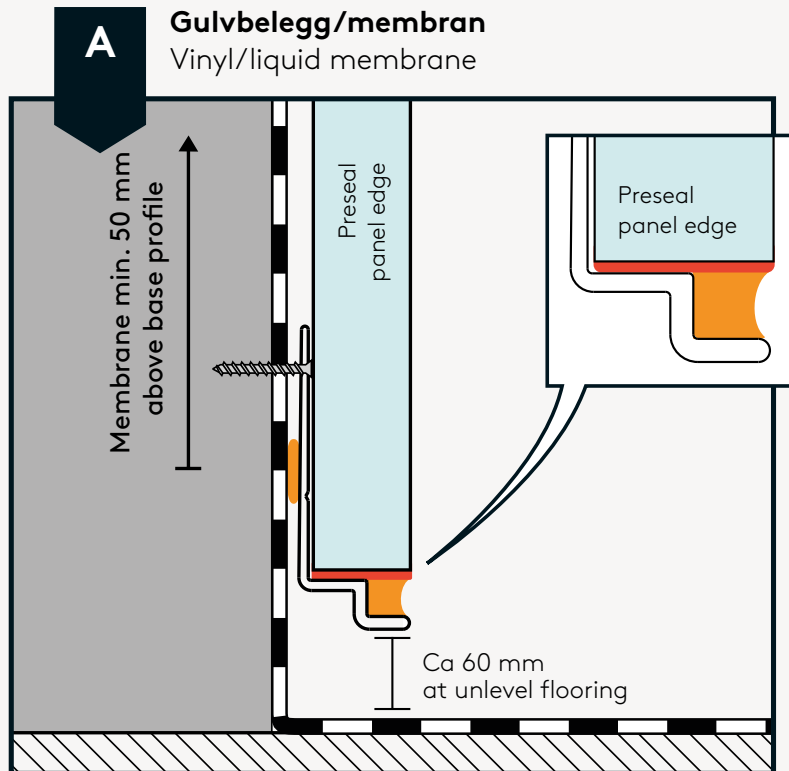

4A

AVSLUTNING MOT GULVMEMBRAN CHOOSE TRANSITION TO FLOOR MEMBRANE

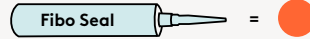

Universelt godkjente løsninger, testet i henhold til EAD 030437-00-0503.
Universal approved solutions, tested according to EAD 030437-00-0503.

 = 
Sealing of panel lip, marked in orange.

 = 
Presealing of panel edge, marked in red.

EAD 030437-00-0503 er referert til i:
EAD 030437-00-0503 is referred to in:



BVN 34.510

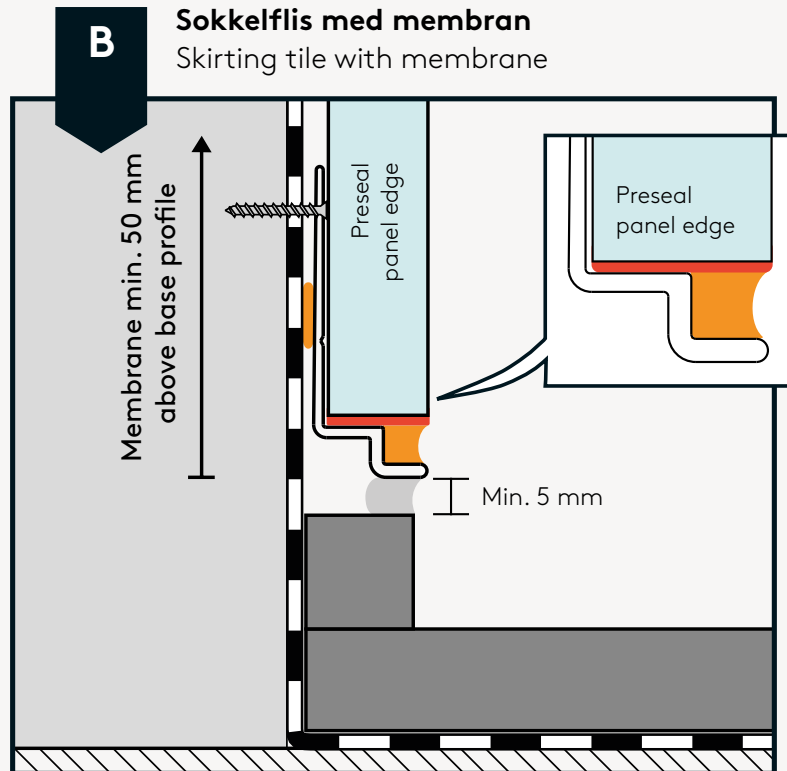

4B

AVSLUTNING MOT GULVMEMBRAN CHOOSE TRANSITION TO FLOOR MEMBRANE

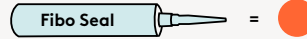

Universelt godkjente løsninger, testet i henhold til EAD 030437-00-0503.
Universal approved solutions, tested according to EAD 030437-00-0503.

 = 
Sealing of panel lip, marked in orange.

 = 
Presealing of panel edge, marked in red.

EAD 030437-00-0503 er referert til i:
EAD 030437-00-0503 is referred to in:

4C

AVSLUTNING MOT GULVMEMBRAN CHOOSE TRANSITION TO FLOOR MEMBRANE

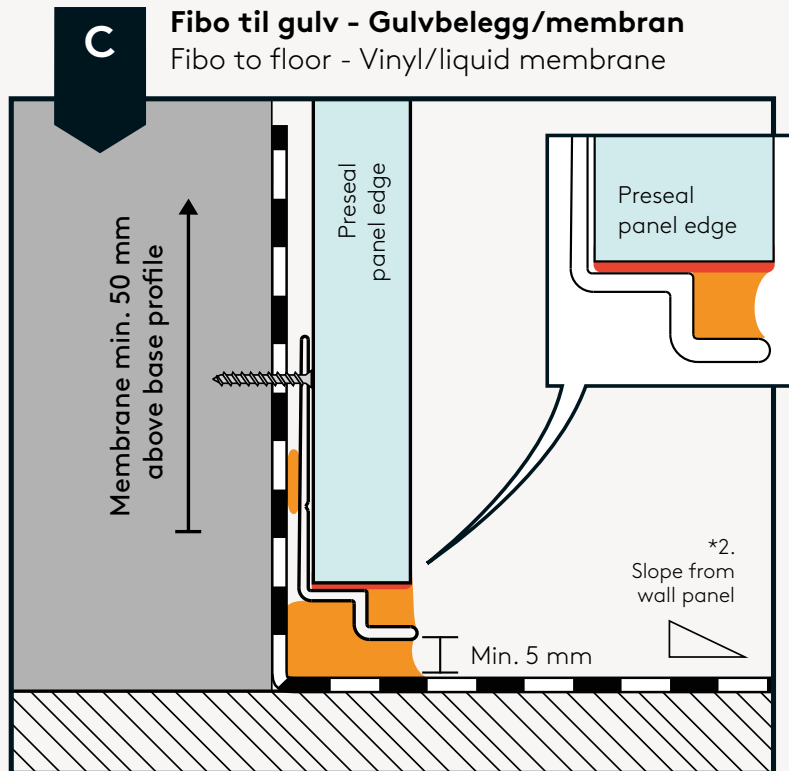

Universelt godkjente løsninger, testet i henhold til EAD 030437-00-0503.
Universal approved solutions, tested according to EAD 030437-00-0503.

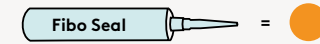

Sealing of panel lip, marked in orange.

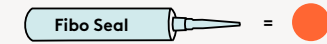

Presealing of panel edge, marked in red.



Krav ved montering til gulv:

1. Gulvet hvor sokkelprofil monteres må være i vater
2. Gulvet må ha helning fra vegg mot sluk
3. Fibo Seal bør påføres mellom sokkelprofil og gulv for å unngå oppsamling av smuss

Requirements for installation to floor:

1. The floor must be level where the base profile is installed
2. The floor must obtain a slope from the wall towards the drainage point
3. Sealant should be applied between base profile and flooring to maintain sanitary conditions

EAD 030437-00-0503 er referert til i:
EAD 030437-00-0503 is referred to in:



BVN 34.510

5A

MONTERING MED TO-DELT INNENDIG HJØRNEPROFIL INSTALLATION WITH TWO-PART INTERNAL CORNER PROFILE



Velg en av våre hjørneprofiler: To-delt, skjult eller standard
Choose one of the following Corner Profiles: Two-part, hidden or standard

NB: Det anbefales bruk av vuggende bevegelse når man klikker panelene sammen for å sikre en god sammenføyning av Aqualock. Bruk av Fibo Grip vil gi økt kontroll under sammenføyning. Ved behov kan man slå forsiktig mot spikerleppen på høyre side av panelet med Fibo Tapping Tool for å sikre at panelet er helt i lås.
NB: It is recommended to use a cradling movement back and forth when clicking the panels together to ensure a good joining of the Aqualock. Using Fibo Grip will give increased control during joining. If necessary, you can carefully tap the nail lip on the right side of the panel with the Fibo Tapping Tool to ensure that the panel is completely locked.

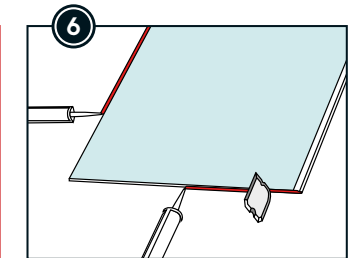
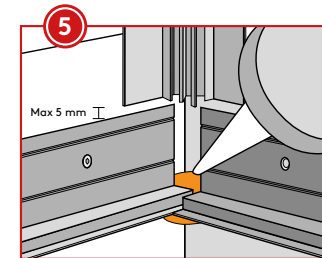
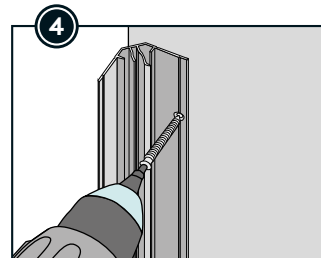
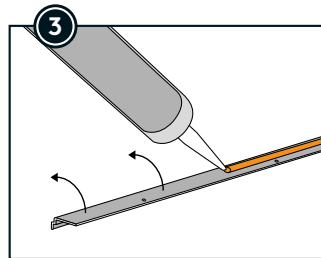
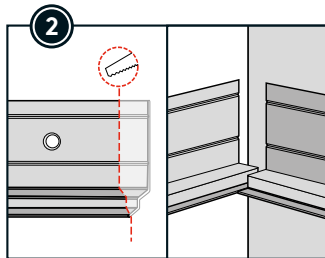
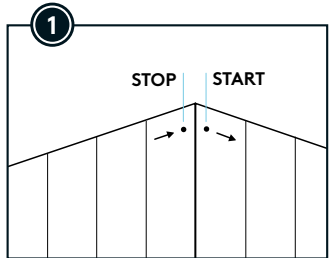

Crucial step to ensure a watertight result.

Preseal cut surfaces and panel bottom edge.

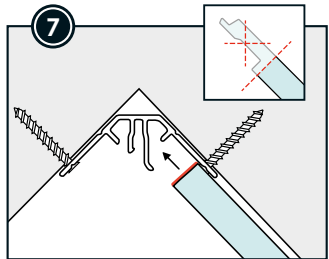

Remove Aqualock and preseal cut edges.

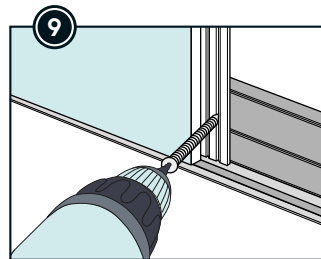
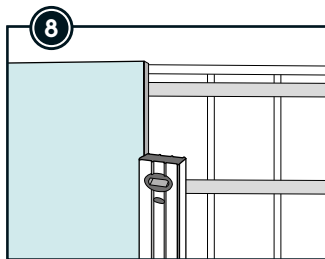

First screw through base profile.

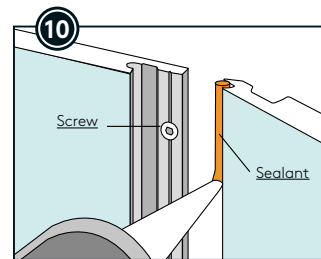

Screw distance c/c 200 mm. Mind the force of drilling to avoid excessive screw penetration.

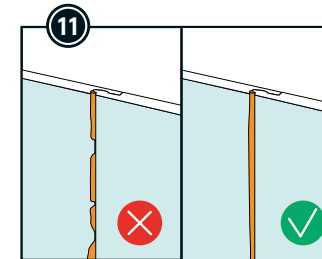

Avoid use of excessive force when installing. This may harm the Aqualock.

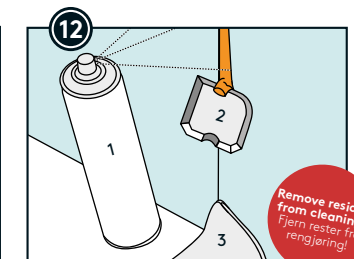

Remove residue from cleaning! Fjern rester fra rengjøring!

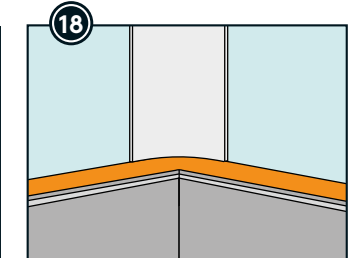
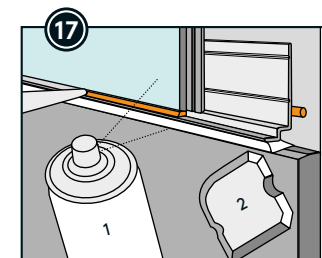
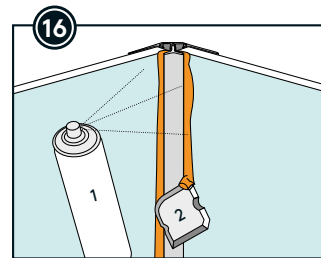
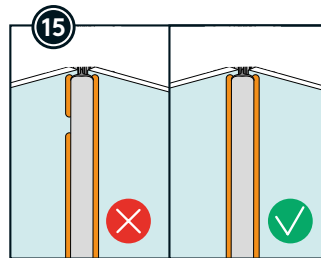
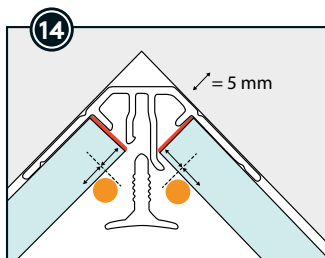
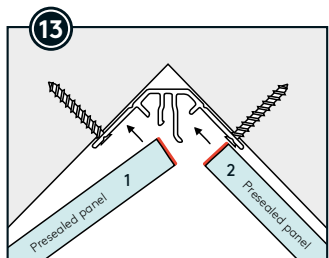

Do not place corner profile further down than this.

5B

MONTERING MED SKJULT INNENDIG HJØRNEPROFIL INSTALLATION WITH HIDDEN INTERNAL CORNER PROFILE



Velg en av våre hjørneprofiler: To-delt, skjult eller standard
Choose one of the following Corner Profiles: Two-part, hidden or standard

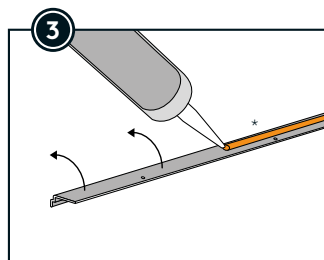
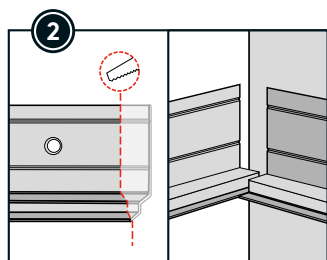
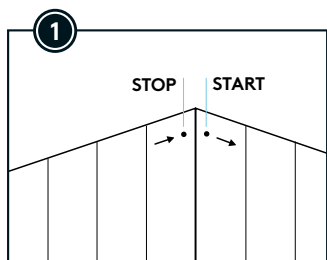

* Fibo Adhesive can be used instead of Fibo Seal.

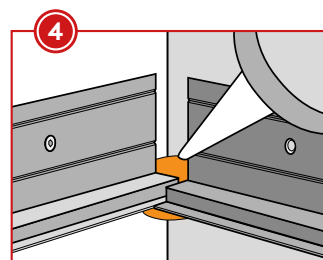

Crucial step to ensure a watertight result.

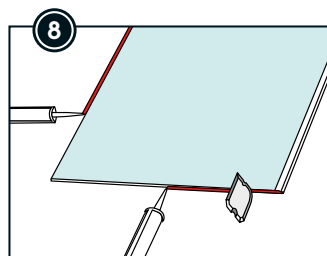
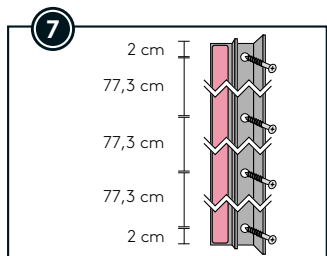
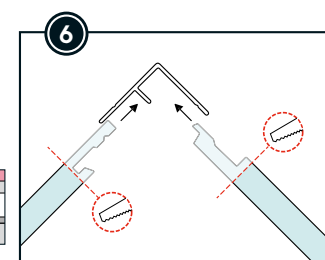
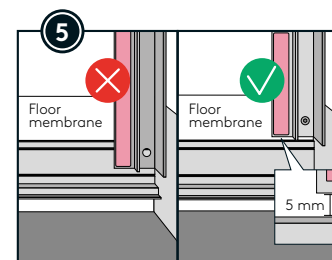

Preseal cut surfaces and panel bottom edge.

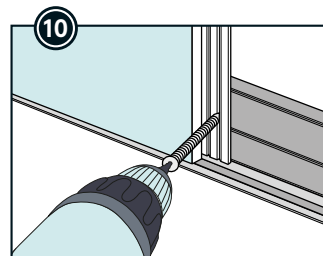
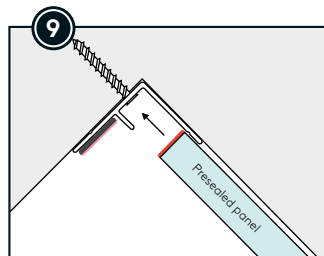

First screw through base profile.

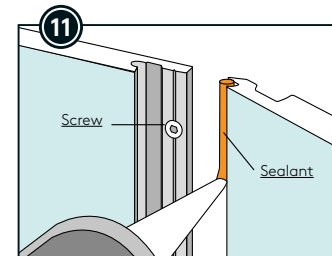

Screw distance c/c 200 mm. Mind the force of drilling to avoid excessive screw penetration.

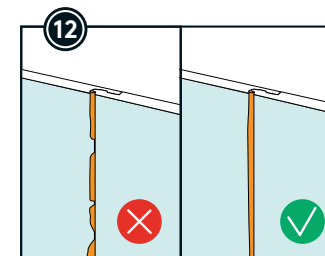

Avoid use of excessive force when installing. This may harm the Aqualock.

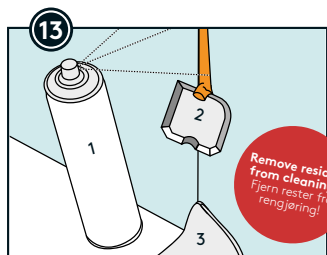

Remove residue from cleaning!
Fjern rester fra rengjøring!

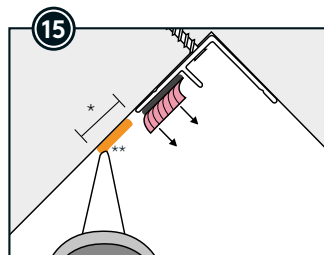
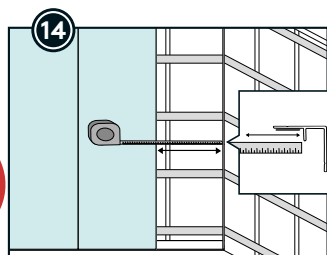

* If backwall with strips, bead must be 18 mm.
With board backwall the bead should be 6 mm.
** Fibo Adhesive can be used instead of Fibo Seal.

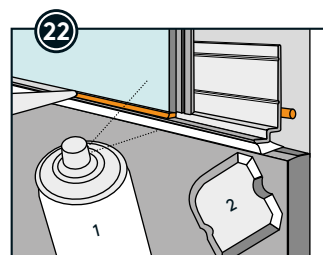
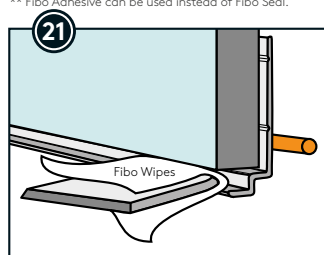
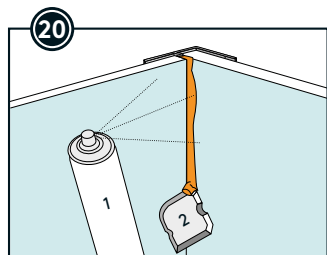
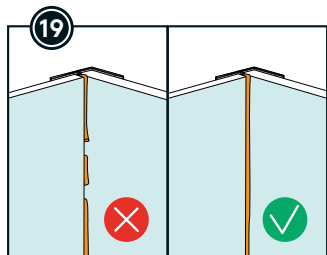
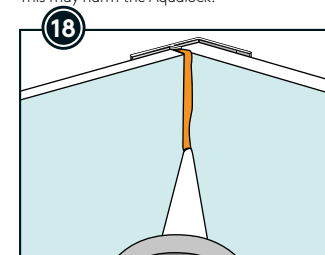
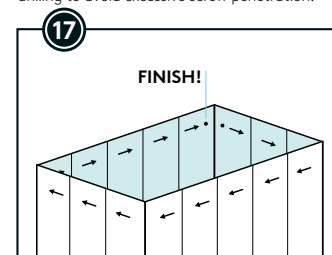
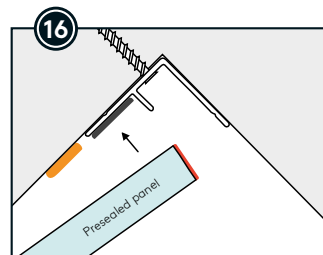

NB: Det anbefales bruk av vuggende bevegelse når man klikker panelene sammen for å sikre en god sammenføyning av Aqualock. Bruk av Fibo Grip vil gi økt kontroll under sammenføyning. Ved behov kan man slå forsiktig mot spikerleppen på høyre side av panelet med Fibo Tapping Tool for å sikre at panelet er helt i lås.

NB: It is recommended to use a cradling movement back and forth when clicking the panels together to ensure a good joining of the Aqualock. Using Fibo Grip will give increased control during joining. If necessary, you can carefully tap the nail lip on the right side of the panel with the Fibo Tapping Tool to ensure that the panel is completely locked.

5C

MONTERING MED STANDARD INNENDIG HJØRNEPROFIL INSTALLATION WITH STANDARD INTERNAL CORNER PROFILE



Velg en av våre hjørneprofiler: To-delt, skjult eller standard
Choose one of the following Corner Profiles: Two-part, hidden or standard

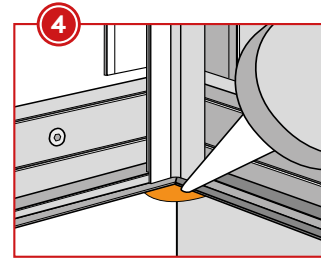
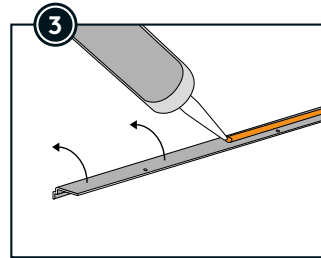
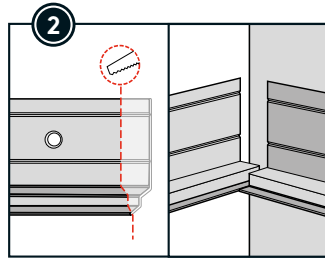
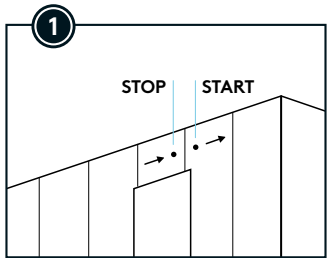

Crucial step to ensure a watertight result.

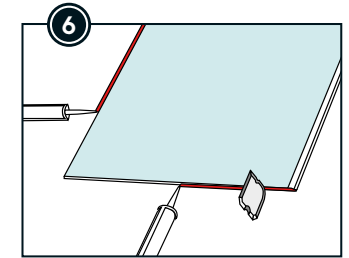
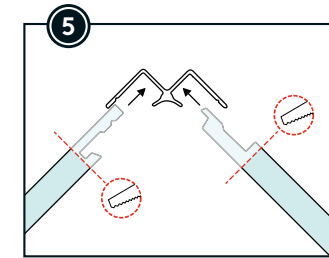

Preseal cut surfaces and panel bottom edge.

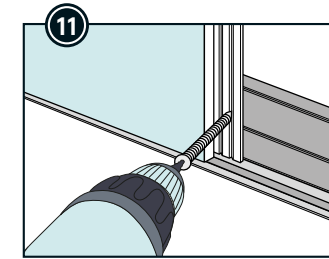
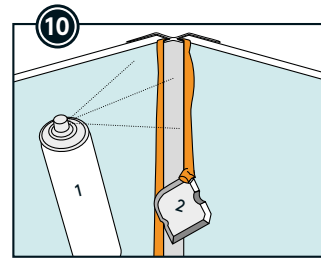
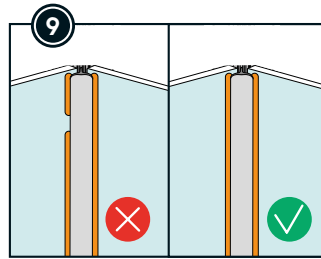
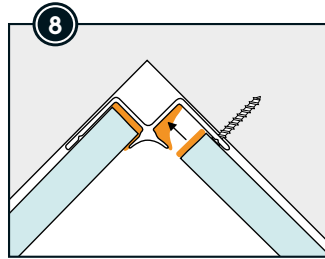
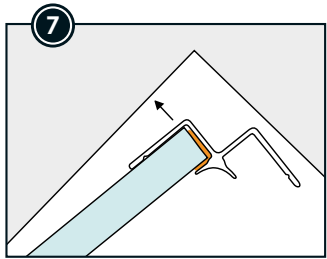

First screw through base profile.

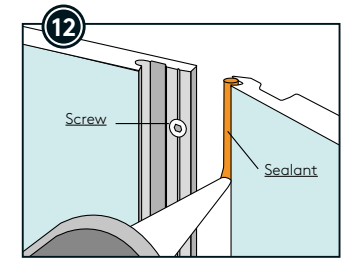

Screw distance c/c 200 mm. Mind the force of drilling to avoid excessive screw penetration.

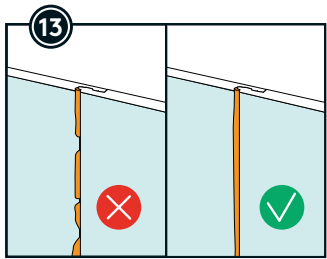

Avoid use of excessive force when installing. This may harm the Aqualock.

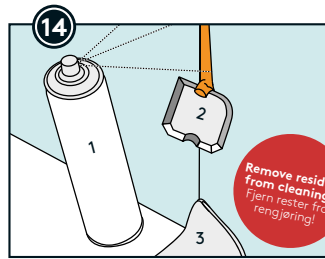

Remove residue from cleaning!
Fjern rester fra fengjering!

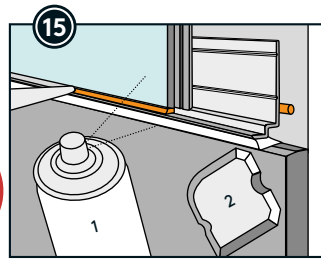

NB: Det anbefales bruk av vuggende bevegelse når man klikker panelene sammen for å sikre en god sammenføyning av Aqualock. Bruk av Fibo Grip vil gi økt kontroll under sammenføyning. Ved behov kan man slå forsiktig mot spikerleppen på høyre side av panelet med Fibo Tapping Tool for å sikre at panelet er helt i lås.

NB: It is recommended to use a cradling movement back and forth when clicking the panels together to ensure a good joining of the Aqualock. Using Fibo Grip will give increased control during joining. If necessary, you can carefully tap the nail lip on the right side of the panel with the Fibo Tapping Tool to ensure that the panel is completely locked.