

LANGBEND 87.5°, 50 MM, Ø75MM
- Rustfritt stål: AISI304/EN1.4301

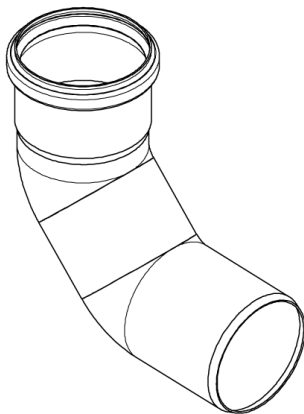

Type nr.: 821.000.075
EAN nr.: 5705499404029
VVS nr.:
RSK nr.: 1551568
NRF nr.: 2170063
LVI nr.:

Type: Bend
Utløpsdia. (mm): 75
Vinkel (°): 87,5
Vekt (kg): 0,50
Materiale: AISI 304
Materiale: EN 1.4301

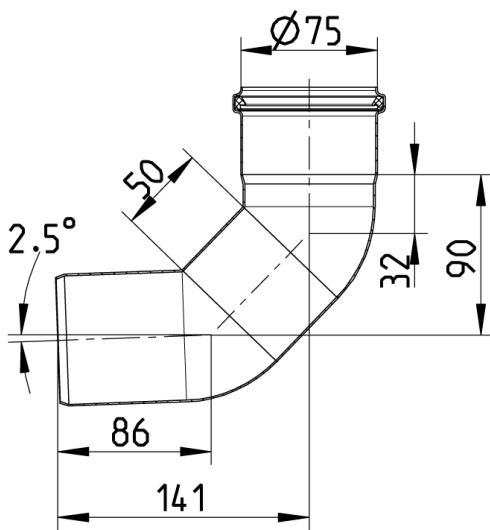

Godkjenninger

ABS - 04-LD472768/3

Achilles - 25316-17

DK - VA 2.12/19349-16

Lloyds Register 92-00041 (E6)

MARINE - R4547 NATO CODIFICATION SYSTEM

NO - 0692-12

PL - Hygenic Certificate - All products

RINA - MAC128714XG EuroPipe

RS - 14.10112.262

RU - 1682258

SE - SITAC 4423/90