



Room unit with PPS interface QAA50.110/101

- Digital, multifunctional room unit for operating heating controllers.
- Room temperature measurement and display
- Setting knob for manual setpoint adjustment
- Operating mode and a presence button

Application

Use

Together with heating controllers for types:

- RVA...
- RVL4...
- RVP...
- RVD...

For plants in:

- Single family houses and duplexes
- Smaller multifamily houses
- Vacation homes and villas

Application

Standard heating systems, such as radiator, convector, floor and ceiling heating systems.

Functions

- | | |
|---------------------|---|
| Main functions | <ul style="list-style-type: none">• Room temperature and display• Setpoint shift• Operating mode selection• Presence selection |
| Operating functions | <ul style="list-style-type: none">• Setting knob for manual setpoint adjustment• Changeover of operating mode• Presence button |
| Other features | <ul style="list-style-type: none">• Communication via PPS• Powered from controller module via PPS |

Type summary

ASN	Type
QAA50.110/101	Room unit with PPS interface

Technical features

Operating mode button

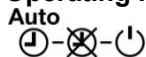

Automatic mode

Control as per scheduler program.

The presence button can temporarily override the heating program. The intervention stays in effect until the next changeover.

Continuous mode

Continuous control to nominal setpoint or reduced setpoint (can be selected with the presence button).

Standby mode

Control is switched off. Frost protection remains, however, active.

Setting knob for setpoint adjustment

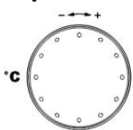

The nominal setpoint can be changed by ± 3 °C using the setting knob for setpoint adjustment. An adjustment is added or subtracted to the programmed nominal setpoint. The reduced setpoint remains, however, unchanged.

Presence button

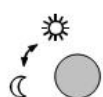

The presence button can change over between nominal setpoint and reduced setpoint.

Display

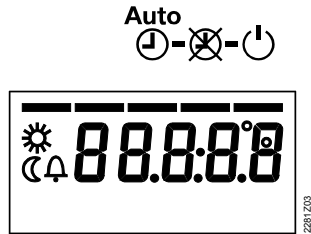

Symbols



Heating to the nominal setpoint.



Heating to the reduced setpoint.

Neither ☀️ nor 🌙

Heating to frost protection setpoint.



The flashing bell indicates one or more errors.

Addressing

The QAA50.101/101 can address heating zones 1 or 2. Addressing takes place on the service level. Addresses 1 and 2 are available. Address 1 is the factory setting.

Procedure

- Long press of the presence button. Activates the service level. "Address 1" is displayed.
- Select address 1 and 2 with the setting knob.

Mechanical design

Device

The unit consists of the following components:

- Housing with integrated electronics and operating elements
- Base for wall mounting with the connection terminals

Operating elements

- Operating mode button
- Setting knob for adjusting the setpoint
- Presence changeover with button

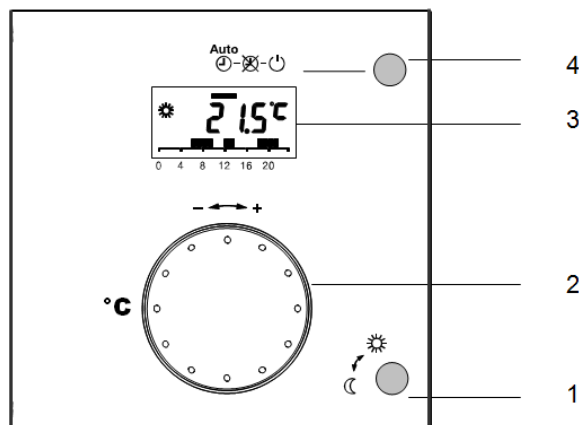

- 1 Presence button
- 2 Setting knob for room temperature setpoint adjustment
- 3 LCD with 5 7-segments, cursors for operating mode display, symbols and bars for time switch program display
- 4 Heating circuit operating mode button and associated symbols

Notes

Product liability

- The products may only be used in building services plant and for applications and features described herein.
- When using the products, all requirements specified under "Technical data" must be observed.
- Comply with all local regulations.

Planning

- The main occupancy or reference room is the proper installation location.
- The installation location is chosen so that the sensor can capture the room temperature as accurately as possible, without being affected by direct solar radiation or other heating or cooling sources
- Mounting height is about 1.5 meters above the floor.
- The unit can be fitted to most commercially available recessed conduit boxes or directly on the wall.

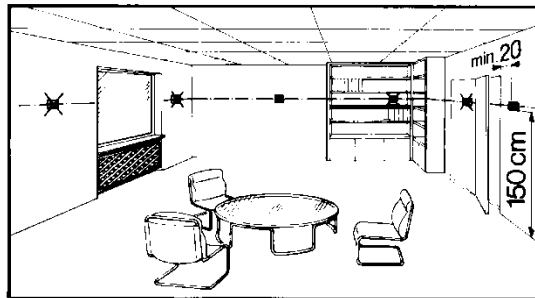

Mounting

Wall mounting with base.

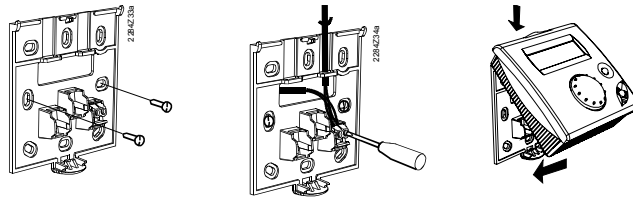

The controller may not be exposed to dripping water.

Installation

Comply with all local regulations for the electrical installations.

Maintenance

Room unit QAA50.110/101 is maintenance free (no batteries to change, no fuses).
Housing is cleaned using a dry rag.

Disposal



In terms of disposal, the devices are classified as electronic scrap in terms of European Directive 2012/19/EU and may not be disposed of as domestic waste.

- Use only designated channels for disposing the devices.
- Comply with all local, applicable regulations.

Technical data

Room temperature measurement	Measuring range	0...45 °C
Power supply	From the controller module	via PPS interface
Communication	PPS	
	Terminals	2-wire connection (interchangeable)
	Cable length	max. 75 m with a cross-section of 0.5 mm ²
	Cable resistance	max. 2 x 3 Ohm
	Power consumption	45 mW (typical)
Degree of protection and safety class	Device protective type	III as per EN 60730-1
	Degree of protection of housing	IP 20 per EN 60529
	Degree of pollution	2 to EN 60 730-1 suitable for residential, commercial and industrial environment
Environmental conditions	Operation	Class 3K5 to IEC 721-3-3
	Temperatures	0...50 °C (noncondensing)
	Humidity	< 85 % rh
	Transport	Class 3K5 to IEC 721-3-2
	Temperatures	-25..0.70 °C
	Humidity	< 95 % rh
	Storage	Class 1K3 to IEC 721-3-1
	Temperatures	-25..0.70 °C
	Humidity	< 95 % rh
Directives and standards	Product standard	EN 60730-1 Automatic electrical controls for household and similar use
	Electromagnetic compatibility (field of use)	For residential, commercial and industrial environment
	EU conformity (CE)	CE1T2281xx
Environmental compatibility	Product environmental declaration CE1E2358en03 contains data on environmental-compatible product design and assessment (RoHS compliance, compositions, packaging, environmental benefits and disposal)	
Other features	Clock reserve	None
	Software class	A to EN 60 730
	Weight	approx. 0.17 kg

Connection diagrams

Connection diagram

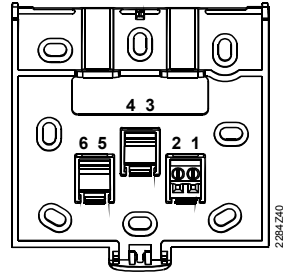

1	D1 (A6)	PPS (interchangeable)
2	D2 (MB)	PPS (interchangeable)
3	-	-
4	-	-
5	-	-
6	-	-

Dimensions

