



**Technical and Test Institute
for Construction Prague**
Prosecká 811/76a
190 00 Prague
Czech Republic
eota@tzus.cz



Member of



www.eota.eu

European Technical Assessment

**ETA 16/0679
of 10/08/2016**

Technical Assessment Body issuing the ETA: Technical and Test Institute
for Construction Prague

Trade name of the construction product

ESSVE ECM

**Product family to which the
construction product belongs**

Product area code: 33
Injection anchors for use in masonry

Manufacturer

ESSVE Produkter AB
SE-164 07 Kista
Esbogatan 14
Sweden

Manufacturing plant(s)

Essve Produkter AB Plant 403-2

**This European Technical Assessment
contains**

16 pages including 12 Annexes which form
an integral part of this assessment.

**This European Technical Assessment is
issued in accordance with regulation
(EU) No 305/2011, on the basis of**

ETAG 029, edition 2013, used as European
Assessment Document (EAD)

Translations of this European Technical Assessment in other languages shall fully correspond to the original issued document and should be identified as such.

Communication of this European Technical Assessment, including transmission by electronic means, shall be in full (excepted the confidential Annex(es) referred to above). However, partial reproduction may be made, with the written consent of the issuing Technical Assessment Body. Any partial reproduction has to be identified as such.

1. Technical description of the product

The ESSVE ECM for masonry is bonded anchor consisting of cartridge with injection mortar, a plastic sieve sleeve and anchor rod with hexagon nut and washer or internal threaded socket. The steel elements are made of galvanized steel or stainless steel.

The sieve sleeve is pushed into a drilled hole and filled with injection mortar before the anchor rod or the socket with internal thread is placed in the sieve sleeve. The installation of the anchor rod in solid masonry can be also done without sieve sleeve. The steel element is anchored via the bond between metal part, injection mortar and masonry.

The illustration and the description of the product are given in Annex A.

2. Specification of the intended use in accordance with the applicable EAD

The performances given in Section 3 are only valid if the anchor is used in compliance with the specifications and conditions given in Annex B.

The provisions made in this European Technical Assessment are based on an assumed working life of the anchor of 50 years. The indications given on the working life cannot be interpreted as a guarantee given by the producer, but are to be regarded only as a means for choosing the products in relation to the expected economically reasonable working life of the works.

3. Performance of the product and references to the methods used for its assessment

3.1 Mechanical resistance and stability (BWR 1)

Essential characteristic	Performance
Reduction factor for job site tests (β – factor)	See Annex C 1
Characteristic resistance for tension and shear loads	See Annex C 1
Characteristic resistance for bending moments	See Annex C 1
Displacement under shear and tension loads	See Annex C 1
Edge distances and spacing	See Annex B 7

3.2 Safety in case of fire (BWR 2)

Essential characteristic	Performance
Reaction to fire	Anchorage satisfy requirements for Class A1
Resistance to fire	No performance assessed

3.3 Hygiene, health and environment (BWR 3)

Regarding dangerous substances contained in this European Technical Assessment, there may be requirements applicable to the products falling within its scope (e.g. transposed European legislation and national laws, regulations and administrative provisions). In order to meet the provisions of the Regulation (EU) No 305/2011), these requirements need also to be complied with, when and where they apply.

3.4 Safety in use (BWR 4)

For basic requirement safety in use, the same criteria are valid as for Basic Requirement Mechanical resistance and stability.

3.5 Sustainable use of natural resources (BWR 7)

For the sustainable use of natural resources, no performance was determined for this product.

3.6 General aspects relating to fitness for use

Durability and serviceability are only ensured if the specifications of intended use according to Annex B 1 are kept.

4. Assessment and verification of constancy of performance (AVCP) system applied with reference to its legal base

According to the Decision 97/177/EC of the European Commission¹, the system of assessment and verification of constancy of performance (see Annex V to Regulation (EU) No 305/2011) given in the following table applies.

Product	Intended use	Level or class	System
Injection anchors for use in masonry	For fixing and/or supporting to masonry, structural elements (which contributes to the stability of the works) or heavy units	-	1

5. Technical details necessary for the implementation of the AVCP system, as provided in the applicable EAD

5.1 Tasks of the manufacturer

The manufacturer shall exercise permanent internal control of production. All the elements, requirements and provisions adopted by the manufacturer shall be documented in a systematic manner in the form of written policies and procedures, including records of results performed. This production control system shall insure that the product is in conformity with this European Technical Assessment.

The manufacturer may only use raw materials stated in the technical documentation of this European Technical Assessment.

The factory production control shall be in accordance with the control plan which is a part of the technical documentation of this European Technical Assessment. The control plan is laid down in the context of the factory production control system operated by the manufacturer and deposited at Technical and Test Institute for Construction Prague². The results of the factory production control shall be recorded and evaluated in accordance with the provisions of the control plan.

The manufacturer shall, on the basis of a contract, involve a body which is notified for the tasks referred to in section 4 in the field of anchors in order to undertake the actions laid down in section 5.2. For this purpose, the control plan referred to in this section and section 5.2 shall be handed over by the manufacturer to the notified body involved.

The manufacturer shall make a declaration of conformity, stating that the construction product is in conformity with the provisions of this European Technical Assessment.

¹ Official Journal of the European Communities L 073 of 14.03.1997

² The control plan is a confidential part of the documentation of the European technical assessment, but not published together with the ETA and only handed over to the approved body involved in the procedure of AVCP.

5.2 Tasks of the notified bodies

The notified body shall retain the essential points of its actions referred to above and state the results obtained and conclusions drawn in a written report.

The notified certification body involved by the manufacturer shall issue a certificate of constancy of performance of the product stating the conformity with the provisions of this European Technical Assessment.

In cases where the provisions of the European Technical Assessment and its control plan are no longer fulfilled, the notified body shall withdraw the certificate of constancy of performance and inform Technical and Test Institute for Construction Prague without delay.

Issued in Prague on 10.08.2016

By

Ing. Mária Schaan
Head of the TAB

Installation in hollow or perforated brick masonry

Installation of anchor rod with sieve sleeve

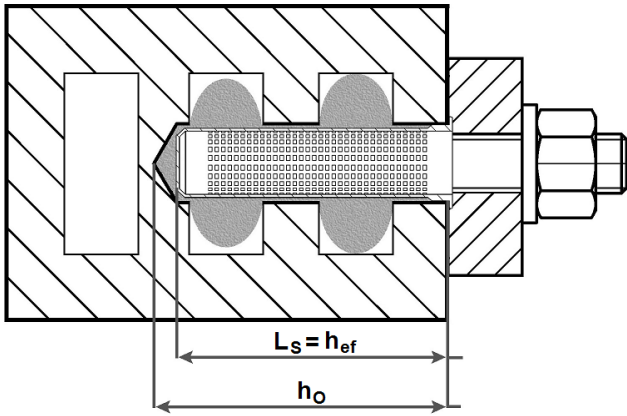

Installation of internal threaded socket with sieve sleeve

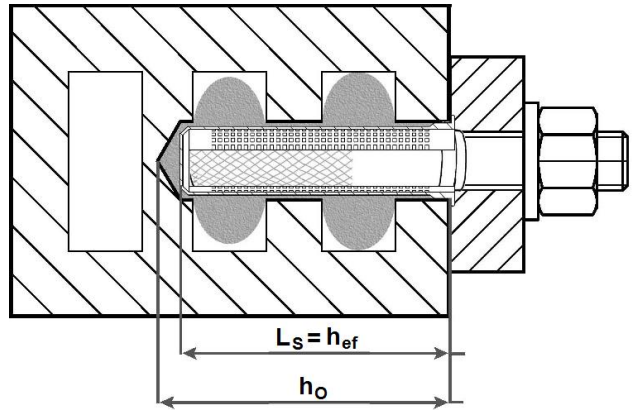

Installation in solid brick masonry

Installation of anchor rod with or without sieve sleeve

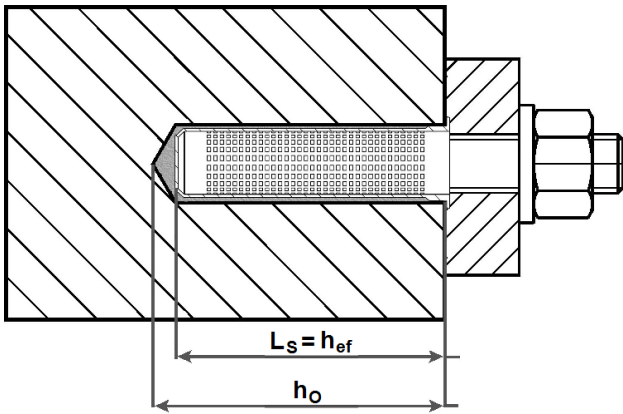

Installation of internal threaded socket with sieve sleeve

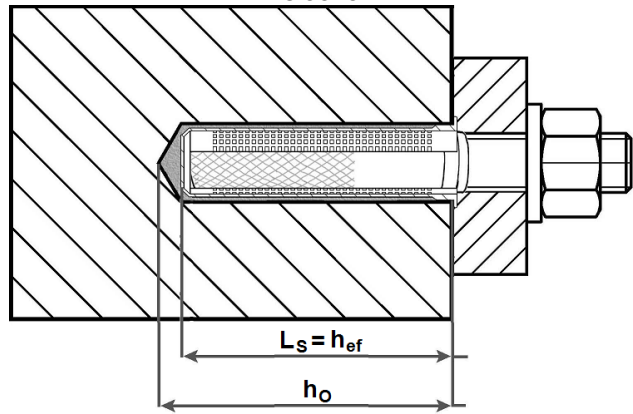

- L_s = length of the sieve sleeve
- h_{ef} = effective setting depth
- h_o = bore hole depth

**ESSVE ECM
for masonry**

Product description
Installed condition

Annex A 1

Cartridge: ESSVE ECM

150 ml, 280 ml, 300 ml up to 330 ml and 380 ml up to 420 ml cartridge (Type: coaxial)

Sealing/Screw cap

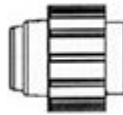

Imprint: ESSVE ECM
processing notes, charge-code, shelf life, hazard-code,
curing- and processing time (depending on the
temperature), with as well as without travel scale

235 ml, 345 ml up to 360 ml and 825 ml cartridge (Type: "side-by-side")

Sealing/Screw cap

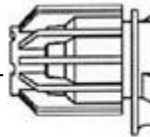

Imprint: ESSVE ECM
processing notes, charge-code, shelf life, hazard-code,
curing- and processing time (depending on the
temperature), with as well as without travel scale

165 ml and 300 ml cartridge (Type: "foil tube")

Sealing/Screw cap

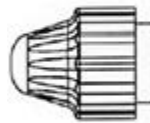

Imprint: ESSVE ECM
processing notes, charge-code, shelf life, hazard-code,
curing- and processing time (depending on the
temperature), with as well as without travel scale

Static mixer



Use category

Base material:

Installation and use:

b and c (solid or hollow masonry)

d/d

w/d

Temperature range:

-40°C to +40°C (max. short. term temperature +40°C and max. long term temperature +24°C)

**ESSVE ECM
for masonry**

Product description
Injection system

Annex A 2

Threaded rod M8, M10, M12

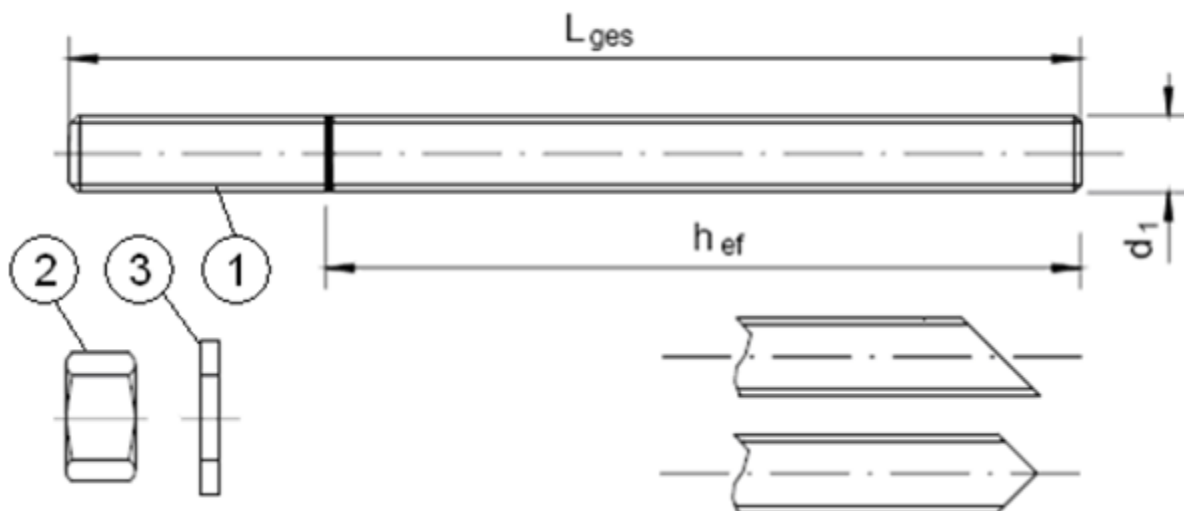

Standard commercial threaded rod with marked embedment depth

Part	Designation	Material
Steel, zinc plated $\geq 5 \mu\text{m}$ acc. to EN ISO 4042 or Steel, hot-dip galvanized $\geq 40 \mu\text{m}$ acc. to EN ISO 1461 and EN ISO 10684 or Steel, zinc diffusion coating $\geq 15 \mu\text{m}$ acc. to EN 13811		
1	Anchor rod	Steel, EN 10087 or EN 10263 Property class 5.8, 8.8, 10.9* EN ISO 898-1
2	Hexagon nut EN ISO 4032	According to threaded rod, EN 20898-2
3	Washer EN ISO 887, EN ISO 7089, EN ISO 7093 or EN ISO 7094	According to threaded rod
Stainless steel		
1	Anchor rod	Material: A2-70, A4-70, A4-80, EN ISO 3506
2	Hexagon nut EN ISO 4032	According to threaded rod
3	Washer EN ISO 887, EN ISO 7089, EN ISO 7093 or EN ISO 7094	According to threaded rod
High corrosion resistant steel		
1	Anchor rod	Material: 1.4529, 1.4565, EN 10088-1
2	Hexagon nut EN ISO 4032	According to threaded rod
3	Washer EN ISO 887, EN ISO 7089, EN ISO 7093 or EN ISO 7094	According to threaded rod

*Galvanized rod of high strength are sensitive to hydrogen induced brittle failure

**ESSVE ECM
for masonry**

Product description
Threaded rod and materials

Annex A 3

Internal threaded socket

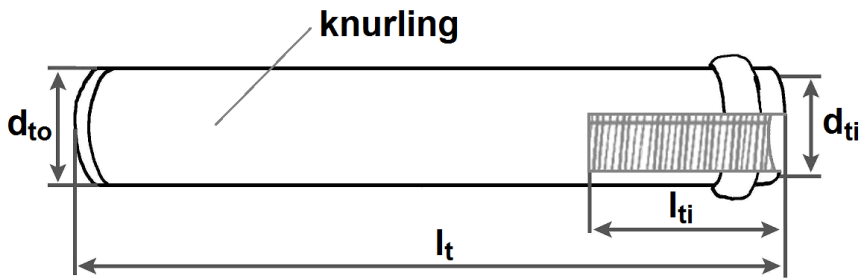

Marking:
Identifying mark of the producer
Size of internal thread e.g. M8

Table A1: Dimensions of internal threaded socket

Internal threaded socket	Inner diameter d_{ti}	Outer diameter d_{to} [mm]	Length of the internal thread l_{ti} [mm]	Total length l_t [mm]
12 x 80	M8	12	30	80
14 x 80	M10	14	30	80
16 x 80	M12	16	30	80

Designation	Material
Internal threaded socket	strength class 5.8 EN ISO 898-1, galvanized $\geq 5 \mu\text{m}$ EN ISO 4042

Sieve sleeve

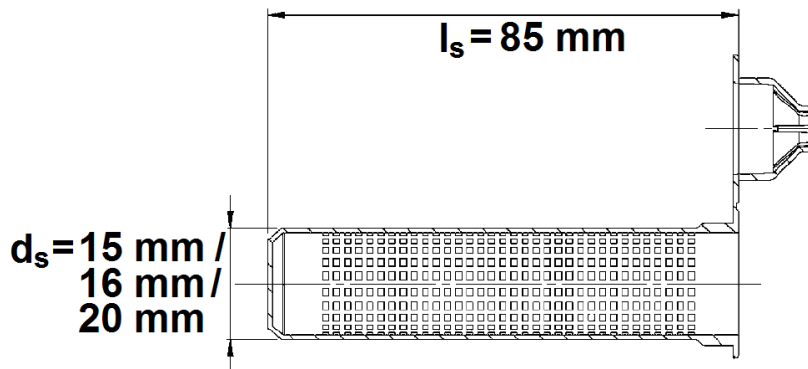

Types:
SH15/85
SH16/85
SH20/25

Designation	Material
Sieve sleeve	Polypropylene

**ESSVE ECM
for masonry**

Product description
Internal threaded socket and materials
Sleeve

Annex A 4

Specifications of intended use

Anchorage subject to:

- Static and quasi-static loads

Base materials

- Solid brick masonry (Use category b), according to Annex B2.
- Hollow brick masonry (Use category c), according to Annex B2 to B3.
- Mortar strength class of the masonry M2,5 at minimum according to EN 998-2:2010.
- For other bricks in solid masonry and in hollow or perforated masonry, the characteristic resistance of the anchorages may be determined by job site tests according to ETAG 029, Annex B and under consideration of the β -factor to Annex C1, Table C1.

Note: The characteristic resistance for solid bricks are also valid for larger brick sizes and larger compressive strength of the masonry unit.

Temperature range:

- T_a : -40°C to +40°C (max. short. term temperature +40°C and max. long term temperature +24°C)

Use conditions (Environmental conditions)

- Structures subject to dry internal conditions (zinc coated steel)

Use categories in respect of installation and use:

- Category d/d
- Category w/d

Design:

- Verifiable calculation notes and drawings are prepared taking account the relevant masonry in the region of the anchorage, the loads to be transmitted and their transmission to the supports of the structure. The position of the anchor is indicated on the design drawings.
- The anchorages are designed in accordance with the ETAG 029, Annex C, Design method A, under the responsibility of an engineer experienced in anchorages and masonry work.

Installation:

- Dry or wet structures
- Anchor Installation carried out by appropriately qualified personnel and under the supervision of the person responsible for technical matters of the site.

**ESSVE ECM
for masonry**

**Intended use
Specifications**

Annex B 1

Table B1: Types and dimensions of block and bricks

Brick N° 1

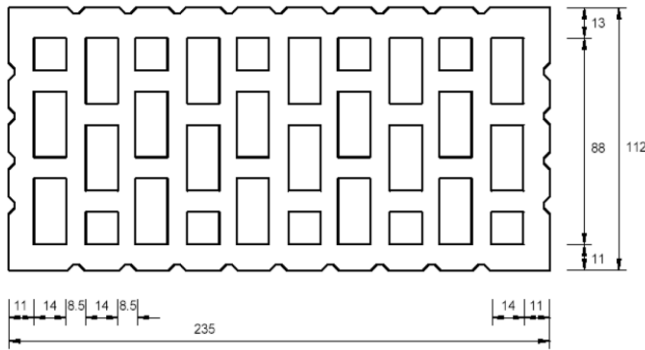

Hollow clay brick HLz 12-1,0-2DF
 according to EN 771-1
 length/width/height = 235 mm/112 mm/115 mm
 $f_b \geq 12 \text{ N/mm}^2$ / $\rho \geq 1,0 \text{ kg/dm}^3$

Brick N° 2

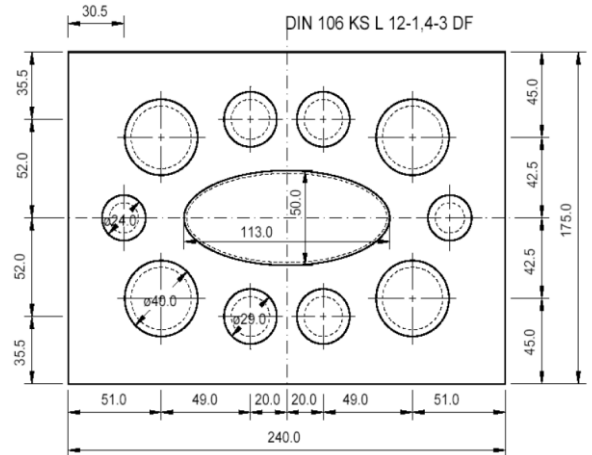

Hollow sand lime brick KSL 12-1,4-3DF
 according to EN 771-2
 length/width/height = 240 mm/175 mm/113 mm
 $f_b \geq 12 \text{ N/mm}^2$ / $\rho \geq 1,4 \text{ kg/dm}^3$

Brick N° 3

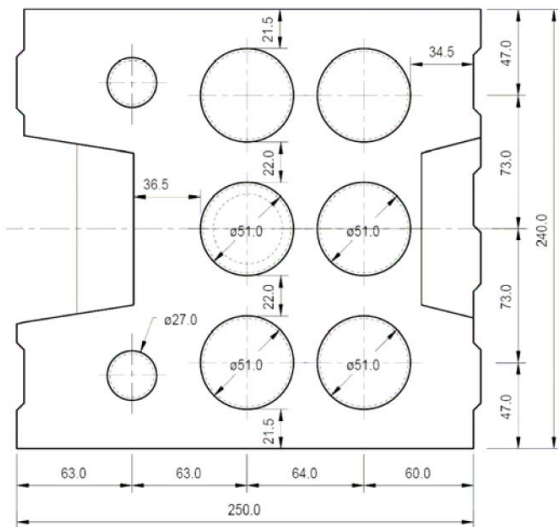

Hollow sand lime brick KSL 12-1,4-8DF
 according to EN 771-2
 length/width/height = 250 mm/240 mm/237 mm
 $f_b \geq 12 \text{ N/mm}^2$ / $\rho \geq 1,4 \text{ kg/dm}^3$

Brick N° 4

Solid clay brick Mz 12-2,0-NF
 according to EN 771-1
 length/width/height = 240 mm/116 mm/71 mm
 $f_b \geq 12 \text{ N/mm}^2$ / $\rho \geq 2,0 \text{ kg/dm}^3$

Brick N° 5

Solid sand lime brick KS 12-2,0-NF
 according to EN 771-2
 length/width/height = 240 mm/115 mm/70 mm
 $f_b \geq 12 \text{ N/mm}^2$ / $\rho \geq 2,0 \text{ kg/dm}^3$

**ESSVE ECM
 for masonry**

Intended use
 Brick types and properties

Annex B 2

Table B2: Types and dimensions of block and bricks

Brick N° 6

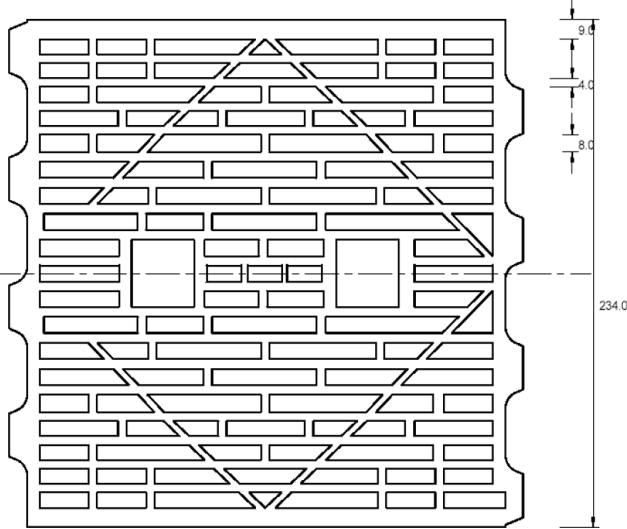

Hollow clay brick HLzW 6-0,7-8DF according to EN 771-1
length/width/height = 250 mm/240 mm/240 mm
 $f_b \geq 6 \text{ N/mm}^2$ / $\rho \geq 0,8 \text{ kg/dm}^3$

Brick N° 7

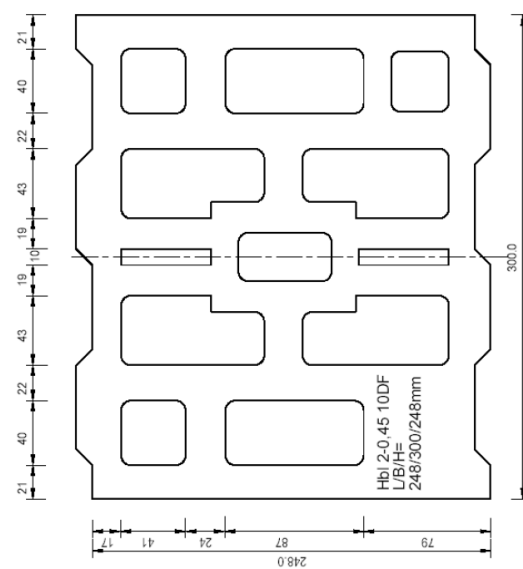

Lightweight concrete hollow block Hbl 2-0,45-10DF according to EN 771-3
length/width/height = 250 mm/300 mm/248 mm
 $f_b \geq 2,0 \text{ N/mm}^2$ / $\rho \geq 0,45 \text{ kg/dm}^3$

Brick N° 8

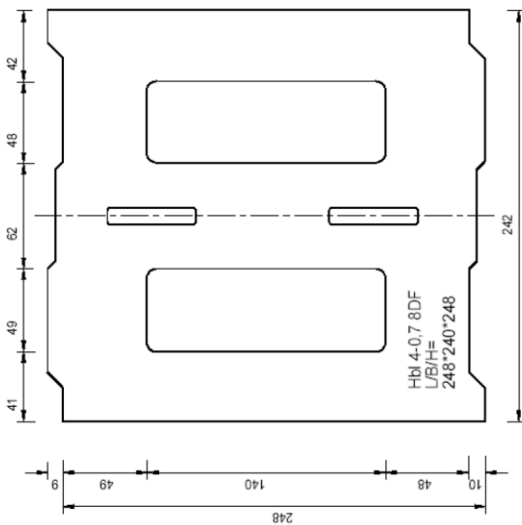

Lightweight concrete hollow block Hbl 4-0,7-8DF according to EN 771-3
length/width/height = 250 mm/240 mm/248 mm
 $f_b \geq 4,0 \text{ N/mm}^2$ / $\rho \geq 0,7 \text{ kg/dm}^3$

Brick N° 9

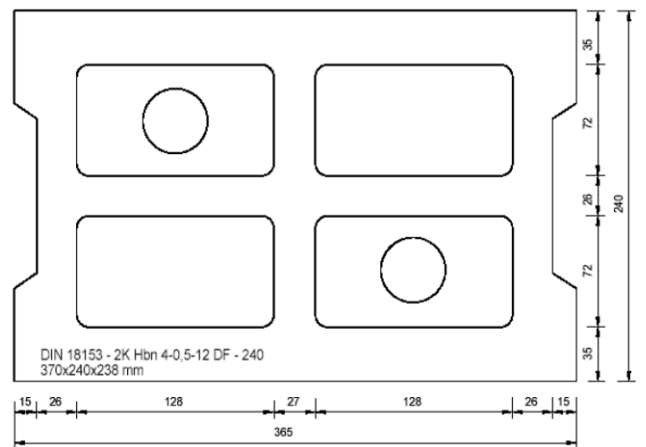

Concrete masonry unit Hbn 4-12DF according to EN 771-3
length/width/height = 370 mm/240 mm/238 mm
 $f_b \geq 4 \text{ N/mm}^2$ / $\rho \geq 1,2 \text{ kg/dm}^3$

**ESSVE ECM
for masonry**

Intended use
Brick types and properties

Annex B 3

Steel brush

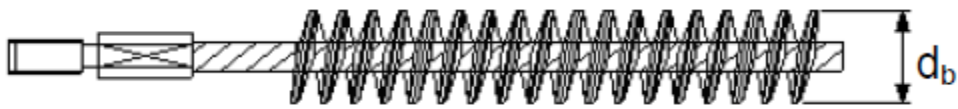

Cleaning pump



**ESSVE ECM
for masonry**

Intended use
Cleaning brush, Cleaning pump

Annex B 4

Assembly instructions

Preparation of cartridge

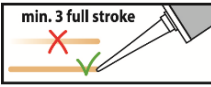
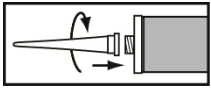

1. Remove the cap and attach the supplied static-mixing nozzle to the cartridge and load the cartridge into the correct dispensing tool. Cut off the foil tube clip before use. For every working interruption longer than the recommended working time (Table B3) as well as for new cartridges, a new static-mixer shall be used.
2. Prior to dispensing into the anchor hole, squeeze out separately a minimum of three full strokes and discard non-uniformly mixed adhesive components until the mortar shows a consistent grey colour.

Installation in solid masonry (without sleeve)



3. Drill a hole into the base material to the size and embedment depth required by the selected anchor (Table B4).

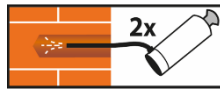
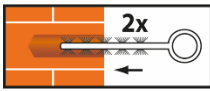
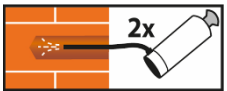

4. Blow from the bottom of the bore hole two times. Brush the hole clean two times, and finally blow out the hole again two times.

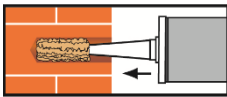

5. Starting from the bottom or back of the cleaned anchor hole fill the hole up to approximately two-thirds with adhesive. Slowly withdraw the static mixing nozzle as the hole fills to avoid creating air pockets. Observe the gel-/ working times given in Table B3.

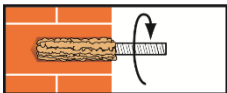

6. Push the threaded rod into the anchor hole while turning slightly to ensure positive distribution of the adhesive until the embedment depth is reached.

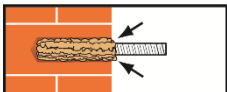

The anchor should be free of dirt, grease, oil or other foreign material.

7. Be sure that the anchor is fully seated at the bottom of the hole and that excess mortar is visible at the top of the hole. If these requirements are not maintained, the application has to be renewed.



8. Allow the adhesive to cure to the specified time prior to applying any load or torque. Do not move or load the anchor until it is fully cured (attend Table B3).

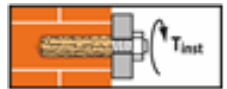

9. After full curing, the add-on part can be installed with the max. torque (Table B4) by using a calibrated torque wrench.

**ESSVE ECM
for masonry**

Intended use
Installation instructions (solid bricks)

Annex B 5

Assembly instructions

Installation in solid and hollow masonry (with sleeve)

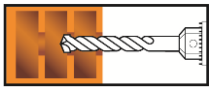

3. Drill a hole into the base material to the size and embedment depth required by the selected anchor (Table 4).

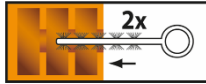
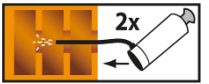

4. Blow from the bottom of the bore hole two times. Brush the hole clean two times, and finally blow out the hole again two times.

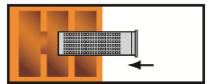

5. Insert the sleeve into the bore hole.

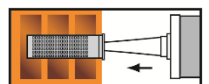

6. Starting from the bottom or back fill the sleeve completely with adhesive. For exact quantity of mortar attend cartridge label.

Observe the gel-/ working times given in Table B3.

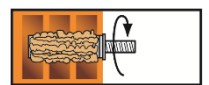

7. Push the threaded rod into the anchor hole while turning slightly to ensure positive distribution of the adhesive until the embedment depth is reached.

The anchor should be free of dirt, grease, oil or other foreign material.

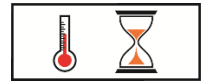

8. Allow the adhesive to cure to the specified time prior to applying any load or torque. Do not move or load the anchor until it is fully cured (attend Table B3).

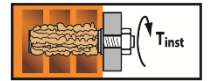

9. After full curing, the add-on part can be installed with the max. torque by using a calibrated torque wrench.

Table B3: Minimum curing time

Base material temperature [°C]	Gelling- / working time [mins]	Minimum curing time [mins]
+5 to +10	10	145
+10 to +20	6	85
+20 to +30	4	50
+30	2	35

**ESSVE ECM
for masonry**

Intended use
Installation instruction (hollow brick)
Gelling and curing time

Annex B 6

Table B4: Installation parameters in solid and hollow masonry

Anchor type		Anchor rod						Internal threaded socket					
Size		M8	M10	M12	M8	M10	M12	M8	M10	M12			
Internal threaded socket	$d_{to \times l_t}$ [mm]	-	-	-	-	-	-	12x80	14x80	16x80			
Sieve sleeve	l_s [mm]	-	-	-	85	85	85	85	85	85			
	d_s [mm]	-	-	-	15	16	15	16	20	15	16	20	20
Nominal drill hole diameter	d_0 [mm]	15	15	20	15	16	15	16	20	15	16	20	20
Diameter of cleaning brush	d_b [mm]	20 \pm 1	20 \pm 1	22 \pm 1	20 \pm 1	20 \pm 1	22 \pm 1	20 \pm 1	22 \pm 1	22 \pm 1			
Depth of the drill hole	h_0 [mm]	90											
Effective anchorage depth	h_{ef} [mm]	85						80					
Diameter of clearance hole in the fixture	$d_f \leq$ [mm]	9	12	14	9	12	14	9	12	14			
Torque moment	$T_{inst} \leq$ [mm]	2											

Table B5: Edge distances and spacing

Base material ¹⁾	Anchor rod								
	M8			M10			M12		
	$c_{cr} \parallel$	$s_{cr \parallel} \parallel$	$s_{cr \perp} \parallel$	$c_{cr} \parallel$	$s_{cr \parallel} \parallel$	$s_{cr \perp} \parallel$	$c_{cr} \parallel$	$s_{cr \parallel} \parallel$	$s_{cr \perp} \parallel$
[mm]	[mm]	[mm]	[mm]	[mm]	[mm]	[mm]	[mm]	[mm]	[mm]
Brick N° 1	100	235	115	100	235	115	120	235	115
Brick N° 2	100	240	113	100	240	113	120	240	113
Brick N° 3	100	250	237	100	250	237	120	250	237
Brick N° 4	128	255	255	128	255	255	128	255	255
Brick N° 5	128	255	255	128	255	255	128	255	255
Brick N° 6	100	250	240	100	250	240	120	250	240
Brick N° 7	100	250	248	100	250	248	-	-	-
Brick N° 8	100	250	248	100	250	248	120	250	248
Brick N° 9	100	370	238	100	370	238	120	370	238

¹⁾ Brick N° according to Annex B 2 and B 3

**ESSVE ECM
for masonry**

Intended use
Working and curing time

Annex B 7

Table C1: Characteristic resistance under tension and shear loading

Base material	Anchor rods $N_{Rk} = V_{Rk}$ [kN] ¹⁾			Internal threaded sockets $N_{Rk} = V_{Rk}$ [kN] ¹⁾		
	M8	M10	M12	M8	M10	M12
Brick N° 1	2,5	2,0	2,0	1,5	2,5	2,5
Brick N° 2	0,75	1,2	0,5	0,6	0,75	0,9
Brick N° 3	0,75	1,2	0,5	-	0,75	0,4
Brick N° 4	1,5	1,5	3,0	2,0	3,0	4,0
Brick N° 5	0,75	0,9	1,5	2,0	1,5	0,9
Brick N° 6	1,2	1,2	0,9	0,9	1,5	0,6
Brick N° 7	0,6	0,3	-	0,5	0,3	0,75
Brick N° 8	0,6	1,5	1,2	-	0,4	0,6
Brick N° 9	2,5	1,5	2,5	0,6	1,2	0,9

¹⁾ For design according ETAG 029, Annex C: $N_{Rk} = N_{Rk,p} = N_{Rk,b} = N_{Rk,s}$; $N_{Rk,pb}$ according to ETAG 029, Annex C For $V_{Rk,s}$ see Annex C1, Table C2; Calculation of $V_{Rk,pb}$ and $V_{Rk,c}$ according to ETAG 029, Annex C

Table C2: Characteristic bending moment

Size		M8	M10	M12
Steel grade 5.8	$M_{Rk,s}$ [N.m]	19	37	66
Steel grade 8.8	$M_{Rk,s}$ [N.m]	30	60	105
Steel grade 10.9	$M_{Rk,s}$ [N.m]	37	75	131
Stainless steel grade A2-70, A4-70	$M_{Rk,s}$ [N.m]	26	52	92
Stainless steel grade A4-80	$M_{Rk,s}$ [N.m]	30	60	105
Stainless steel grade 1.4529 strength class 70	$M_{Rk,s}$ [N.m]	26	52	92
Stainless steel grade 1.4565 strength class 70	$M_{Rk,s}$ [N.m]	26	52	92

Table C3: Displacements under tension and shear load

Base material	F [kN]	δ_{N0} [mm]	$\delta_{N\infty}$ [mm]	δ_{V0} [mm]	$\delta_{V\infty}$ [mm]
Solid bricks	$N_{Rk} / (1,4 \cdot \gamma_M)$	0,6	1,2	1,0 ¹⁾	1,5 ¹⁾
Perforated and hollow bricks		0,14	0,28	1,0 ¹⁾	1,5 ¹⁾

¹⁾ the hole gap between bolt and fixture shall be considered additionally

Table C4: β - factors for job site tests according to ETAG 029, Annex B

Brick N°	N° 1	N° 2	N° 3	N° 4	N° 5	N° 6	N° 7	N° 8	N° 9
β - factor	0,62	0,28	0,22	0,48	0,26	0,43	0,42	0,36	0,60

**ESSVE ECM
for masonry**

Performances

Characteristic resistance, displacement
 β -factors for job site testing under tension load

Annex C 1