

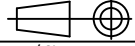

Dato / Date <b>08.02.17</b>	Tegnet / Drawn <b>ME</b>	Proj.metode / Proj.method 	Målestokk / Scale -		
Kontr. / Checked	Godkjent / Approved	Format / Size			
Tittel / Title <b>Rett rør</b> Grå lakkert - Ø150x250 - 2 mm Pipe - Painted Grey				Erstatning for / Repl. for	Erstattet av / Repl. by
				Tegningsn. / Drawing n. <b>10612</b>	
Henvisning / Ref. Ikke til produksjon		Beregning / Calculation		Filnavn / File name	