

*Fully*  
Art. Nr. 2827800  
1/7



02.02.2018

Art. Nr. 2827800

Groundplan - Grundplan - Plan de masse - Planimetria -  
Plattegrond - Põhiplaan

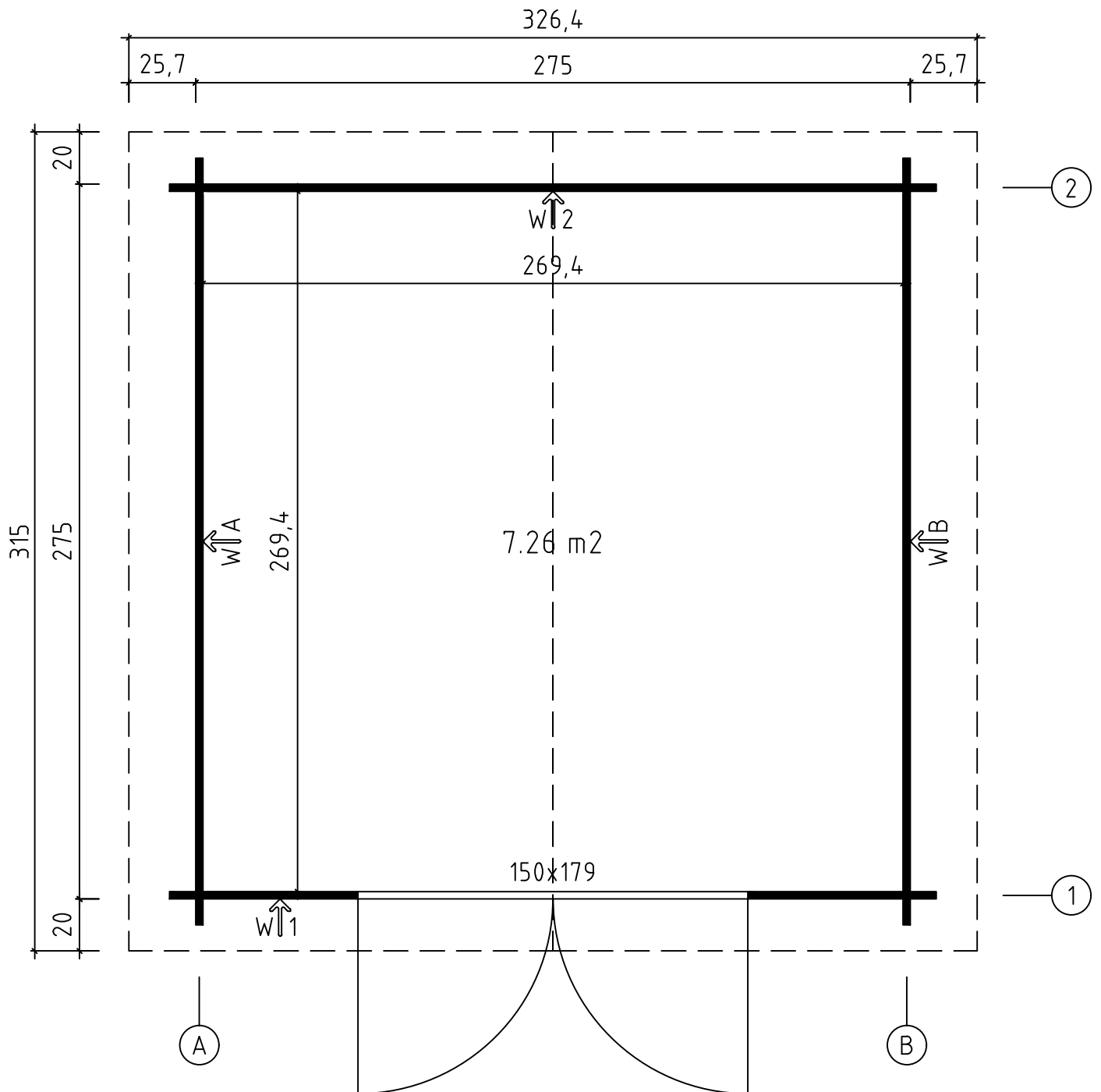

Art. Nr. 2827800

Foundation - Fundament - Fondation -  
Fondamenta - Fundering - Immutatud alusraam

Floor boards - Fussbodenbretter - Plan pose plancher -  
Pavimento - Vloerhout - Põrandalaudis

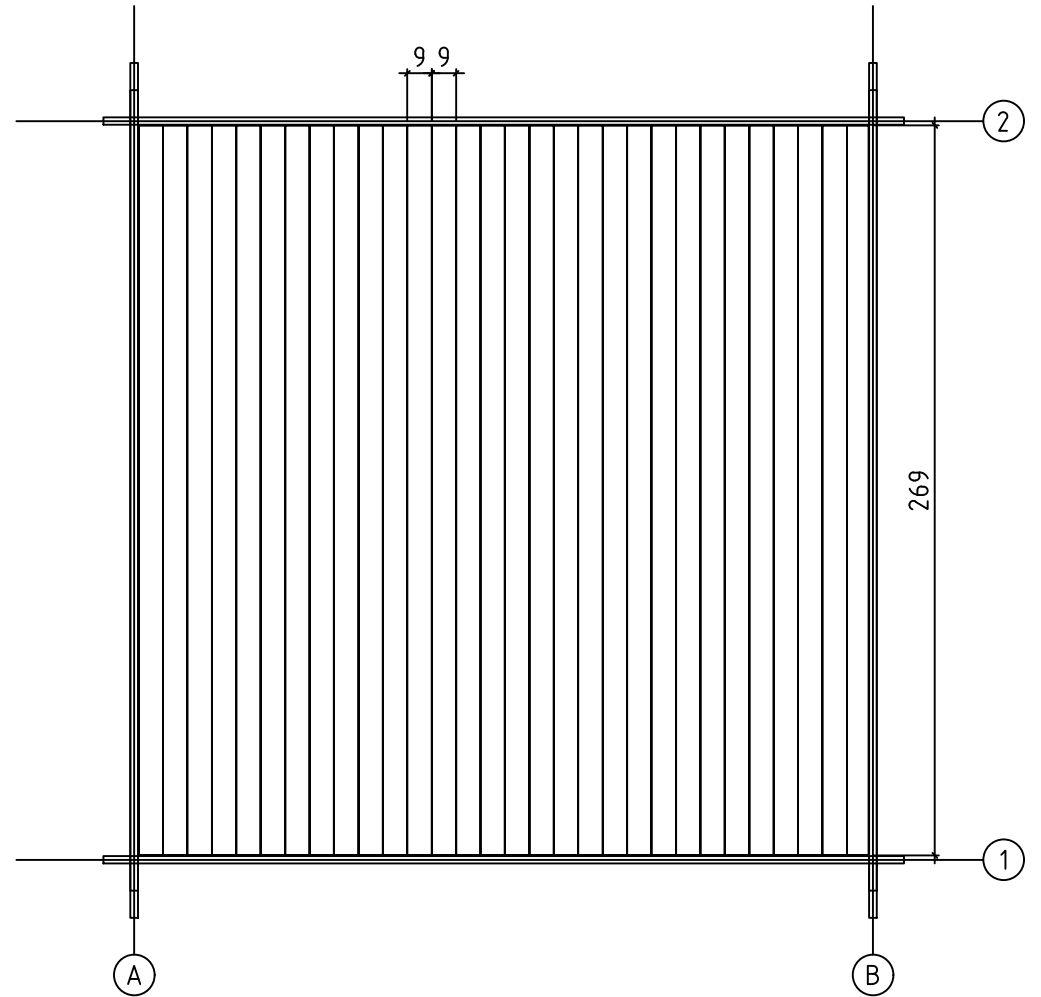
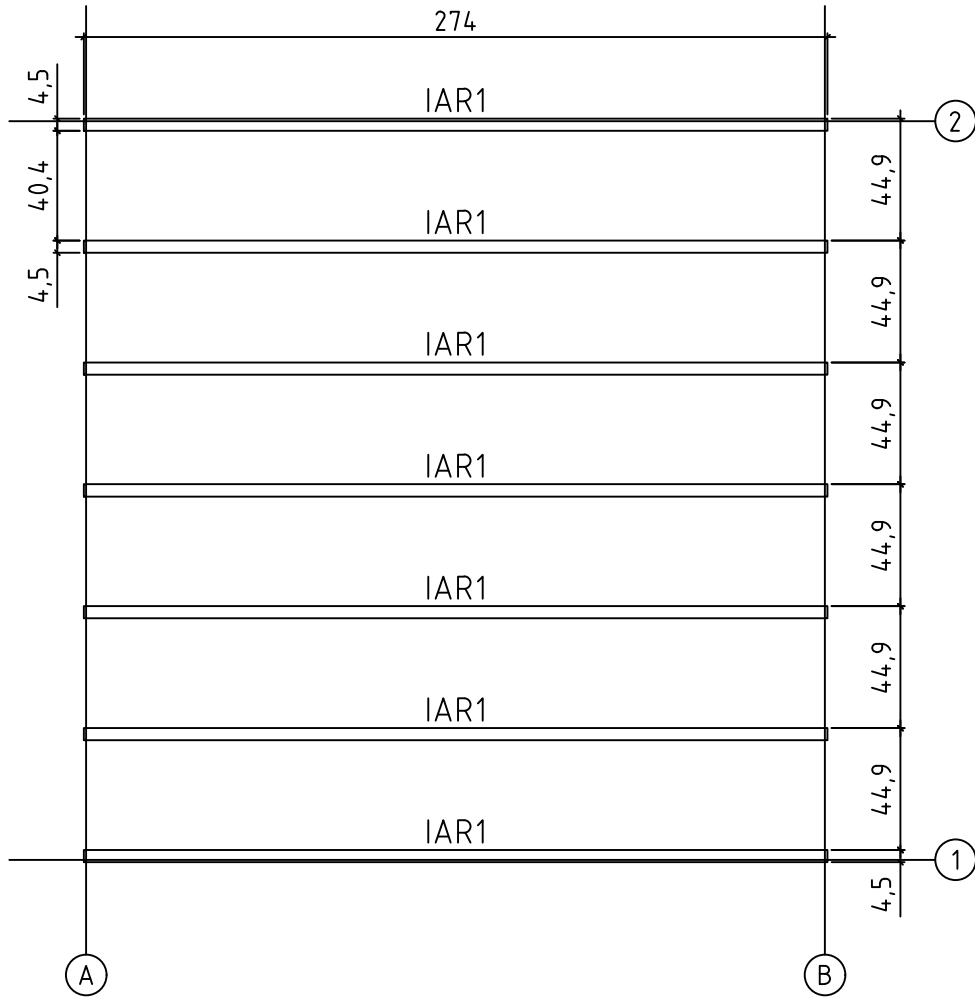



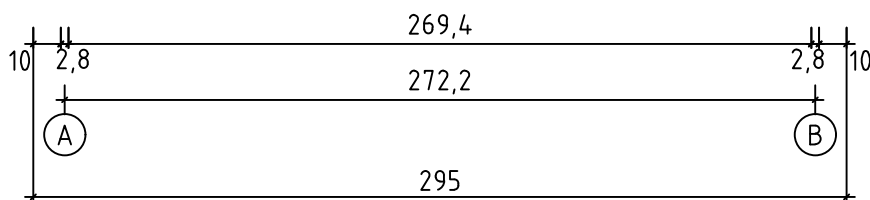
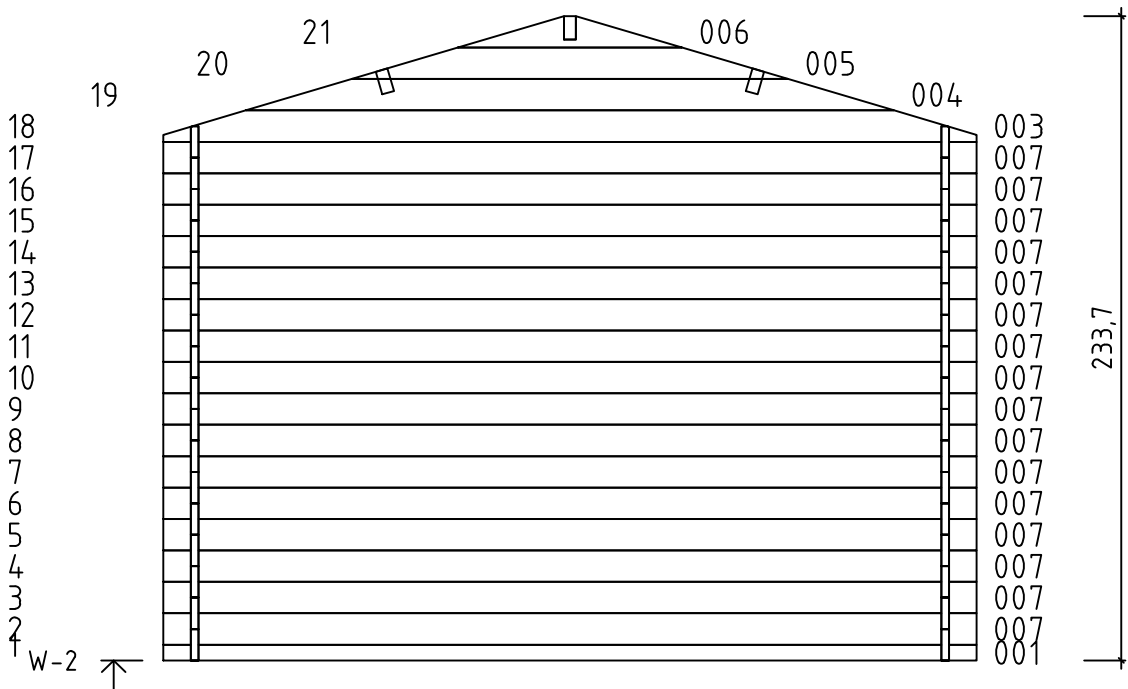
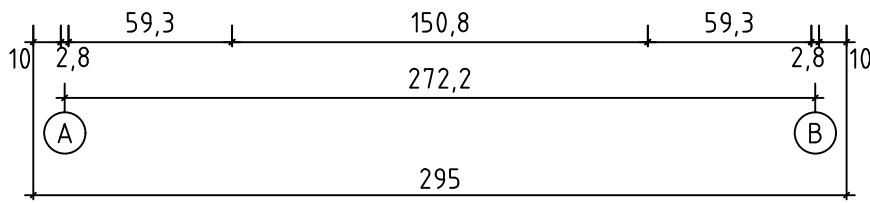
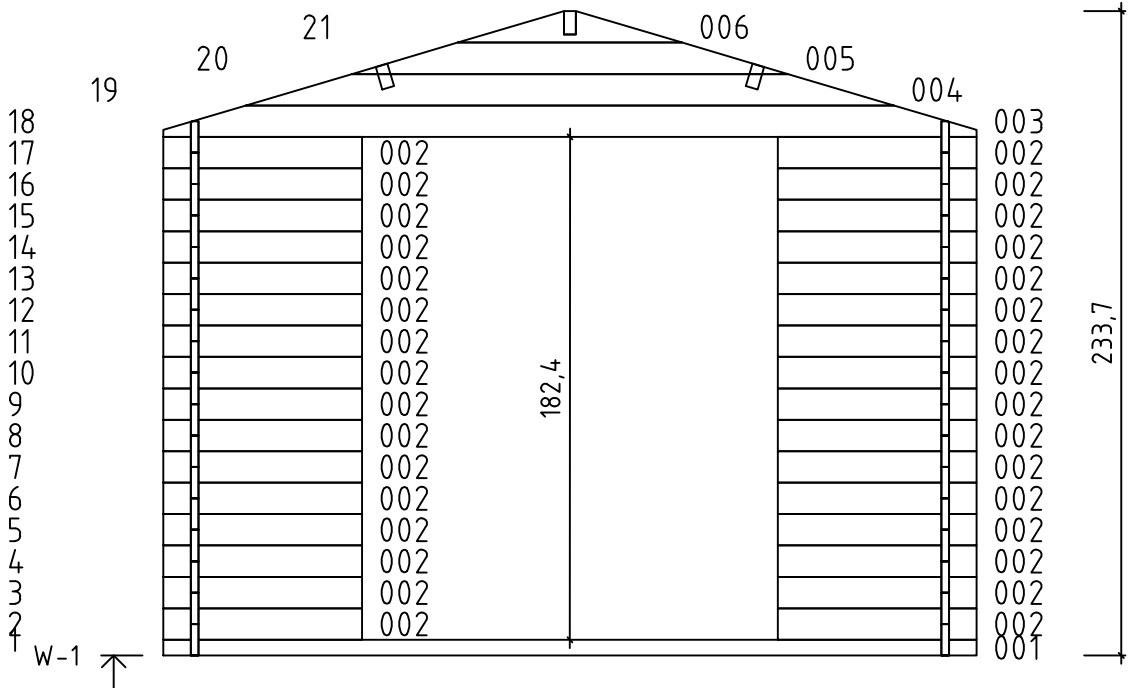



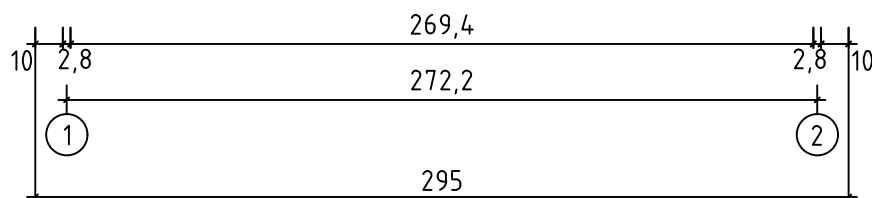
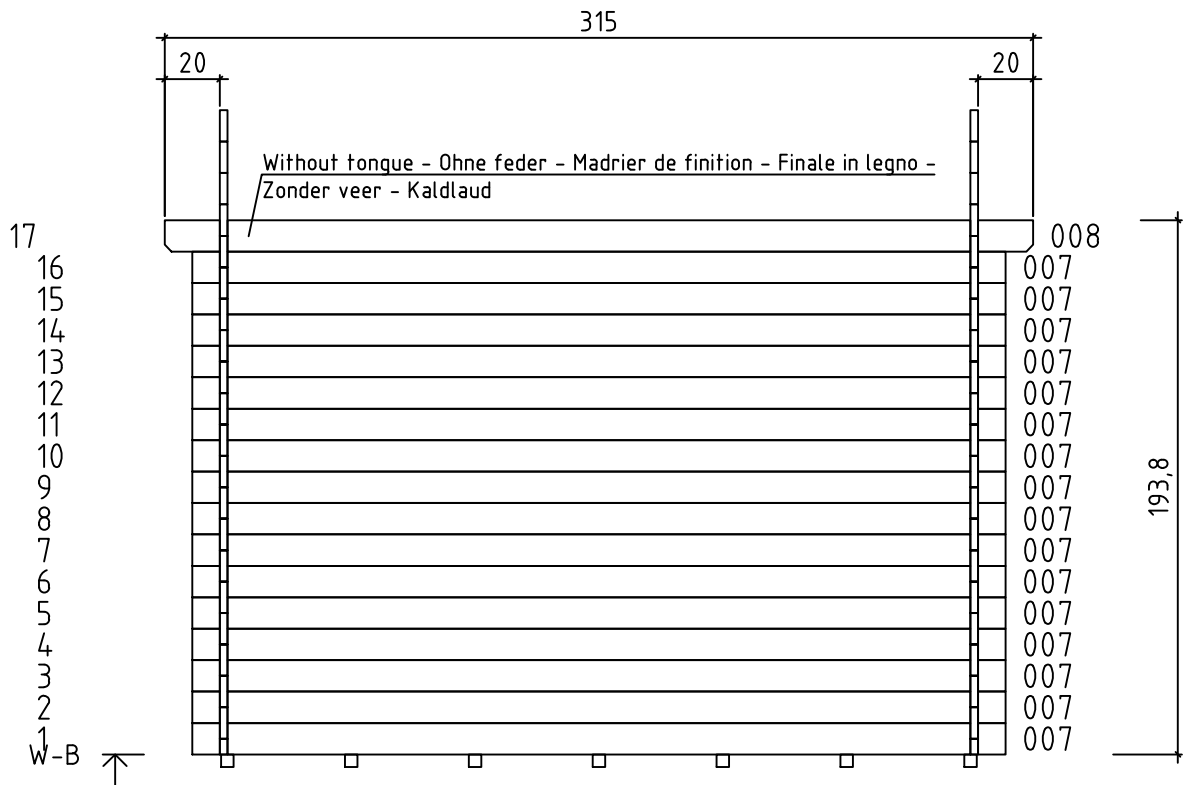
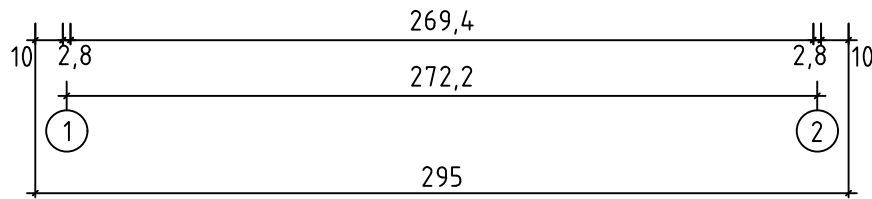
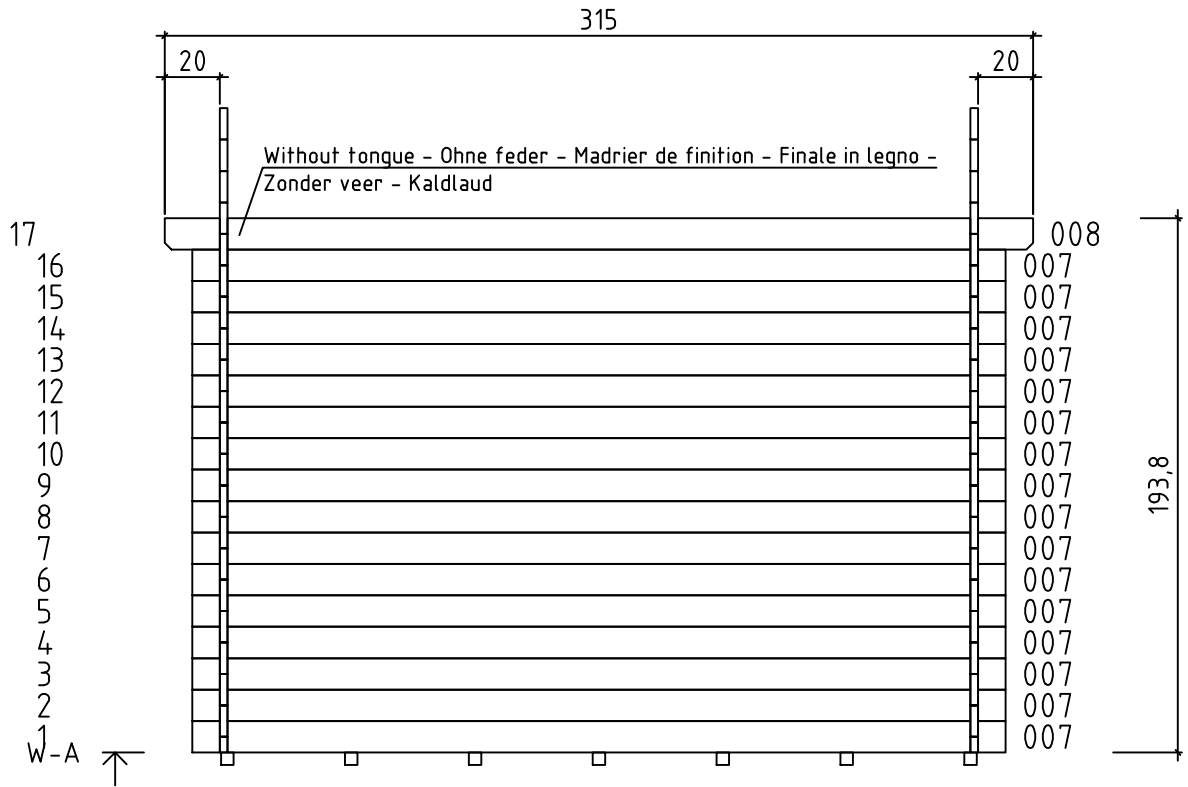

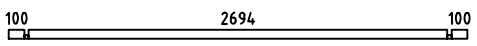
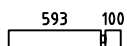
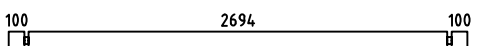
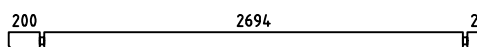
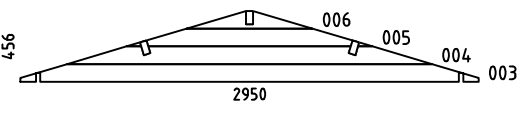
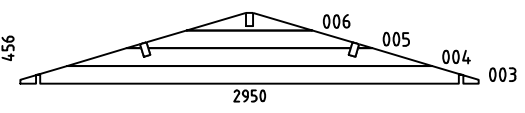
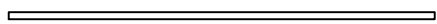
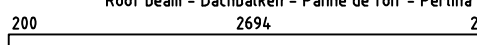
Art. Nr. 2827800

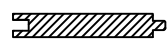

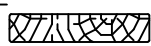
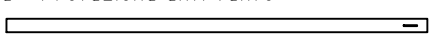
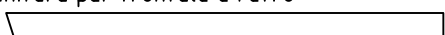

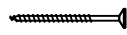
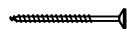
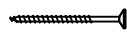

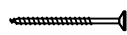



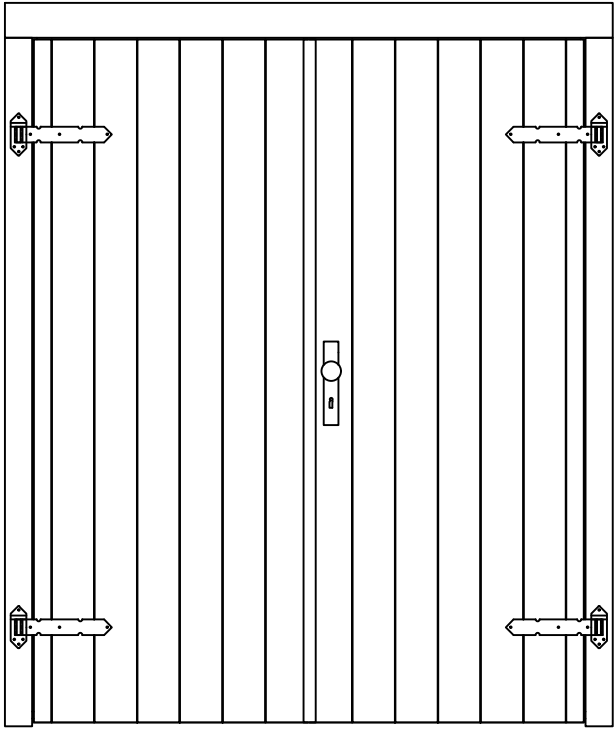
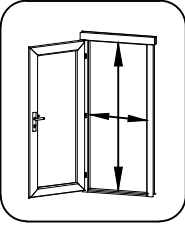





# Art. Nr. 2827800



Pos	02.02.2018 Piece list - Stückliste - Liste des pièces - Elementi - Stuklijst - Tükitalabel Art. Nr. 2827800 6/7	Q	P (mm)	L (mm)
001		2	28x57	2950
002		32	28x114	721
007		48	28x114	2950
008		2	28x120	3150
W1-1		1		
W2-1		1		
IAR1	Foundation - Fundament - Fondation - Fondamenta - Fundering - Immutatud alusraam 	7	45x45	2740
A-PR1	Roof beam - Dachbalken - Panne de toit - Perlina del tetto - Gordingen / dakbalk - Pärilin 	3	44x120	3150
	Floor boards - Fussbodenbretter - Lame de plancher - Pavimento - Vloerhout - Põrandalaud 	30	90x18	2690
	Roof boards - Dachbretter - Voliges - Perlina per tetto - Dakhout - Katuselaud 	70	90x15	1700
	Floor fillet - Fussbodenleiste - Corniere de finition du plancher - Finitura per pavimento (battisco pa) - Vloerafwerkljst - Põrandaliist 		18x18	10.76
	Roofing felt fillet - Dachpappenleiste - Baguette de fixation du feutre bitumeux - Asse per fissaggio guaina bituminosa - Afdekljst asfaltpapier - Katussepapiliist 	4	18x58	1750
TB-1	Fascia board - Traufbrett - Bandeau de toit - Finitura lati tetto - Gevelljst - Räästalaud 	2	18x58	3150
KFS-1	Storm protection - Sturmleiste - Latte anti-tempete - Protezione anti vento - Stormverankering / beveiliging - Tormikinnitusliist 	4	22x45	2050
	Gable moulding - Giebelleiste - Planche de rive - Finitura per frontale e retro del tetto - Gevelljst - Viilulaud 	4	18x120	1750
HS8	Screw for gable segment - Schrauben für deckblatt - Vis pour fixation losange de finition - Viti x frontali tetto - Schroef voor gevelpunt segment - Kruvi rombile 	4	3.5x35	
HS9	Screw for gable moulding - Schrauben für giebelleiste - Vis pour fixation planche de rive - Vite per fissare finiture davanti e dietro del tetto - Schroef voor gevelljst - Kruvi viilulauale 	24	3.5x50	
HS12	Screw for fascia boards - Schrauben für traufbretter - Vis pour fixation bandeau de toit - Viti x striscia del tetto - Schroef voor gevelljst - Kruvi räästalauale 	14	4x40	
HS18	Screw for gable - Schrauben für giebel - Vis pour fixation des pignons - Viti per timpano - Schroef voor gevelpunt - Kruvi kelba kinnitamiseks 	4	5x120	
HS18	Screw for roof beams - Schrauben für dachbalken - Vis pour fixation pannes de toit - Viti per perline del tetto - Schroef voor gordingen / dakbalken - Kruvi pärlineitele 	6	5x120	
HS16	Screw for 1. wall beam - Schraube für 1. bohlenreihe - Vis de fixations 1ere rangée de madriers avec poutrelles de fondations - Vite fissaggio alle fondamenta - Schroef voor 1 wandbalk - Kruvi poollauale 	6	5x90	

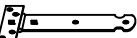

Pos	02.10.2015 Piece list - Stückliste - Liste des pièces - Elementi - Stuklijst - Tükítabel 1500x1790 TUL.1.100.IVP.MXd TZ	1/1	Q	P (mm)	L (mm)
					
					1400x1722 mm
LV	Stricker for lock - Schließblech für türschloss - Gache de porte - L'attaccante piastra - Sluitplaat voor deurslot - Lukuvastus		1		
HS11	Screw for striker plate - Schraube für halteplatte - Vis de fixation gache de porte - Vite per cerniera a piastra - Schroef voor slotplaat - Kruvi kuuriluku vastusele		2	2.5x25	
HS12	Screw for door lock covers - Schrauben für schlossblenden - Vis pour fixation garniture de porte - Viti per la copertura della serratura della porta - Schroef voor deurslot sluitplaat - Kruvi lukuplaatidele		2	3.5x20	
HS12	Screw for latch bolt for gate - Schraube für doppeltürfeststellriegel - Vis de fixation des loquets de fermeture pour porte double vantaux - Vite per il fermo della porta - Schroef voor dubbele deur vergrendelingsbout - Kruvi riivile		8	3.5x20	
HS6	Screw for doorstep - Schrauben für swelle - Vis pour fixation barre de seuil - Vite per soglia della porta - Schroef voor deurdorpel - Kruvi lävepaku kinnitamiseks alusraamiga		3	3.5x50	
HS6	Screw for door jamb - Schraube für türrahmen - Vis de fixation partie haute avec montants du cadre de porte - Viti x fissaggio montanti porte - Schroef voor deurkozijn - Kruvi ukse lengile		2	3.5x50	
HS7	Screw for door fillet - Schraube zur befestigung türleiste - Vis pour fixation baguette d'arret de porte - Viti per massellino della porta - Schroef voor deurlijst - Kruvi ukse kokkuvaltšiliistule		5	3x30	
HS9	Screw for door hinges - Schrauben für torriegel - Vis pour fixation charniere de porte - Vite per cerniere - Schroeven voor deurscharnier - Kruvi T-hingele		24	4x30	
HS5	Screw for door lock - Schrauben für türschloss - Vis de fixation serrure - Viti per serratura della porta - Schroef voor deurslot - Kruvi kuuri lukule		4	4x30	
HS1	Screw for door jamb - Schraube für türrahmen - Vis de fixation partie haute avec montants du cadre de porte - Viti x fissaggio montanti porte - Schroef voor deurkozijn - Kruvi ukse lengile		2	5x90	
LP	Door lock cover - Schlossblende - Garniture de porte - Copertura per serratura - Deurschild - Pindluku lingiplaat		1		
KL	Door lock - Türschloss - Serrure de porte - Serratura - Deur slot - Pindluuk kuurite		1		
RI	Latch bolt for double door - Türriegel - Loquet pour double porte - Scrocco per porta doppia - Nachtslot - Riiv		2		
TT	Door hinges - Torriegel - Gonds de porte - Cerniere - Deur scharnier - T-hing		4		



